

**TANA** 

15/1933.xx

15/1934.xx

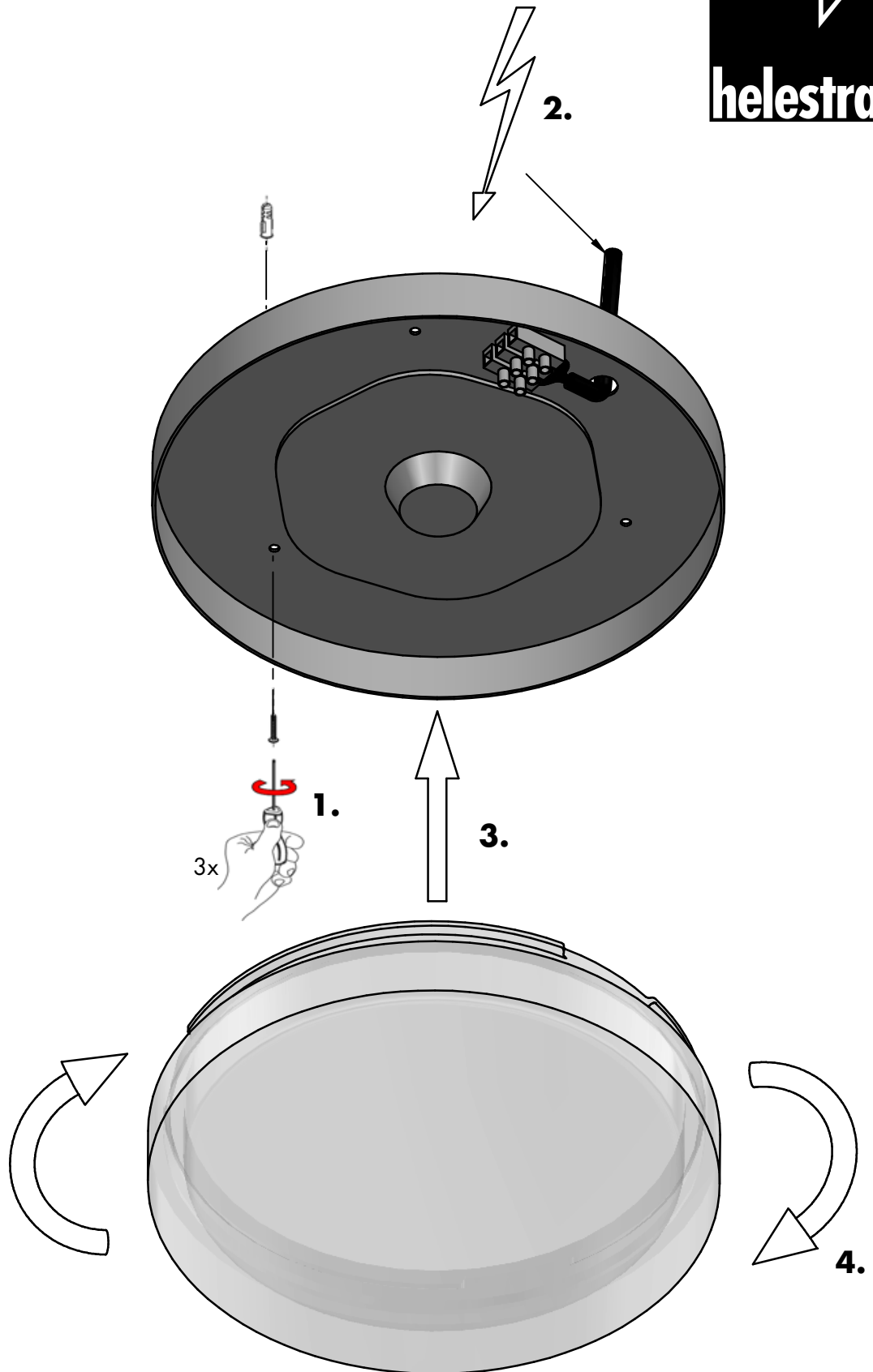
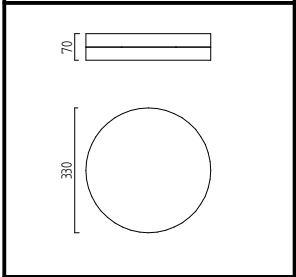
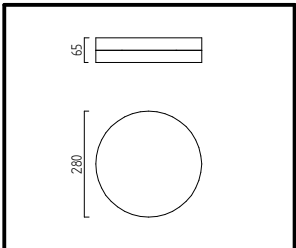
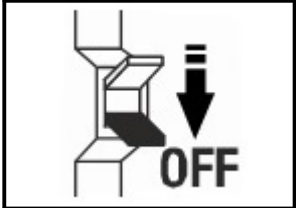
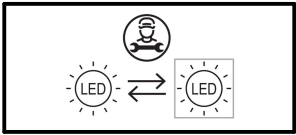
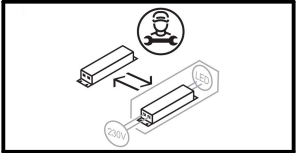

Bitte beachten Sie unsere allgemeinen Hinweise !  
Please observe our general information !  
Nous vous prions d'observer nos instructions générales !  
Observen por favor nuestra información general !

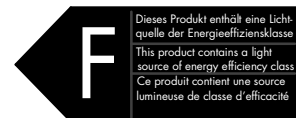

[www.helestra.de/installation](http://www.helestra.de/installation)

**Helestra Leuchten GmbH**

An den Breiten 7, 01454 Leppersdorf, Deutschland/Germany

[www.helestra.de](http://www.helestra.de)