

Artemide®

Empatia 26 / 36

design

C. de Bevilacqua - P. di Arianello

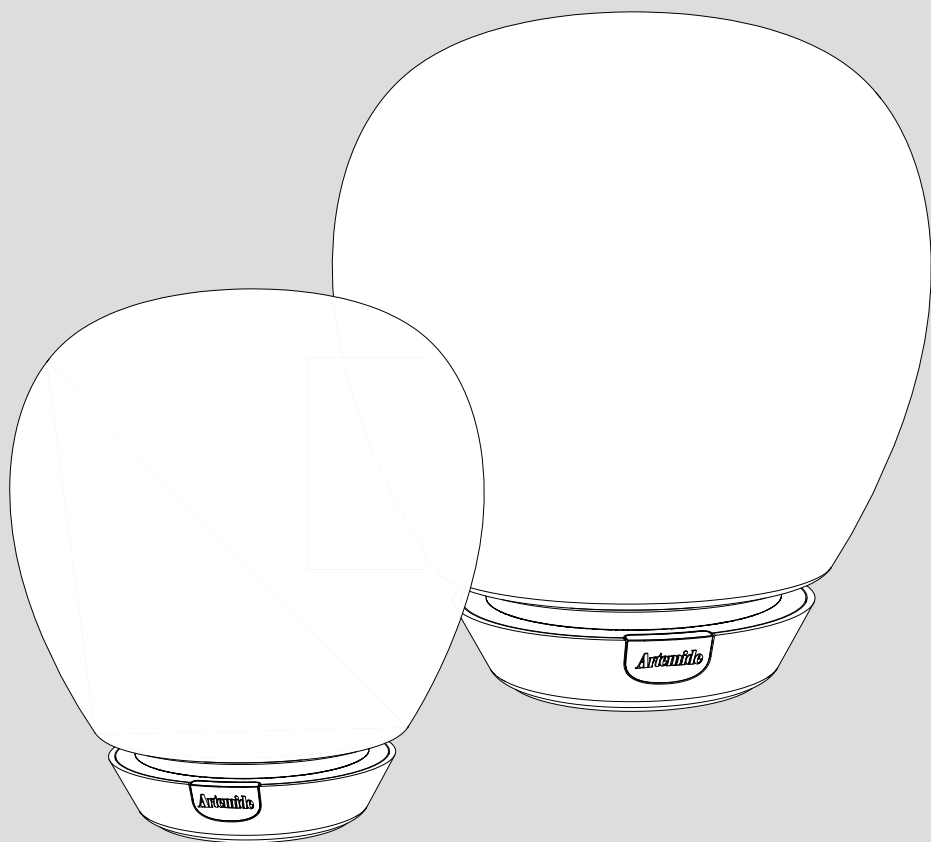



i

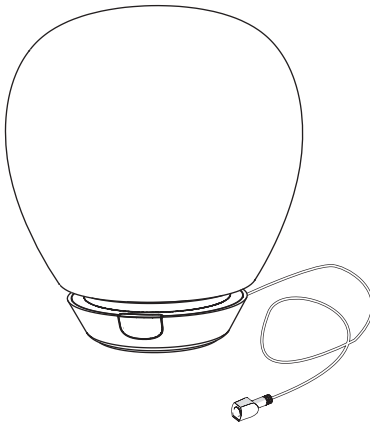
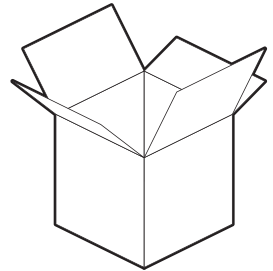
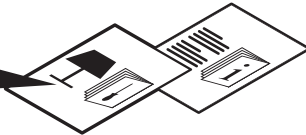
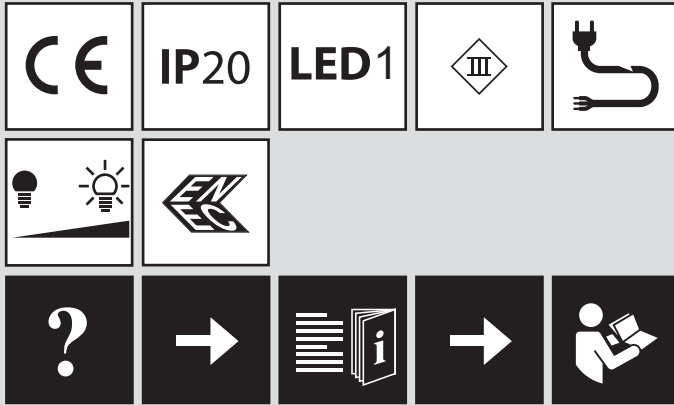

SELV
EN 61347-2-13



1

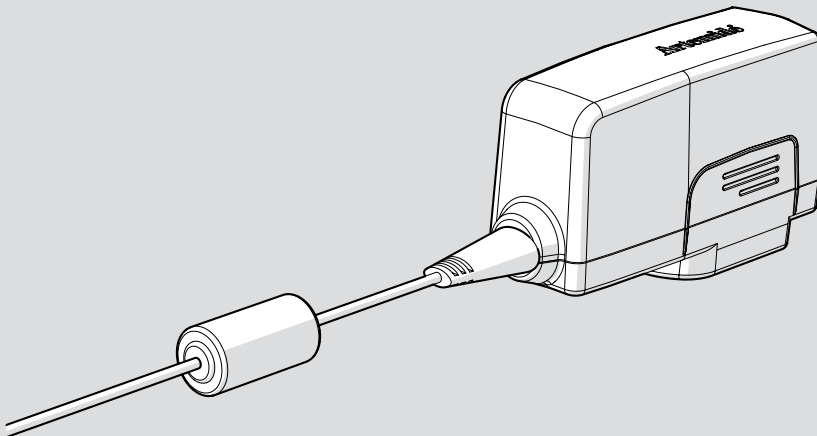
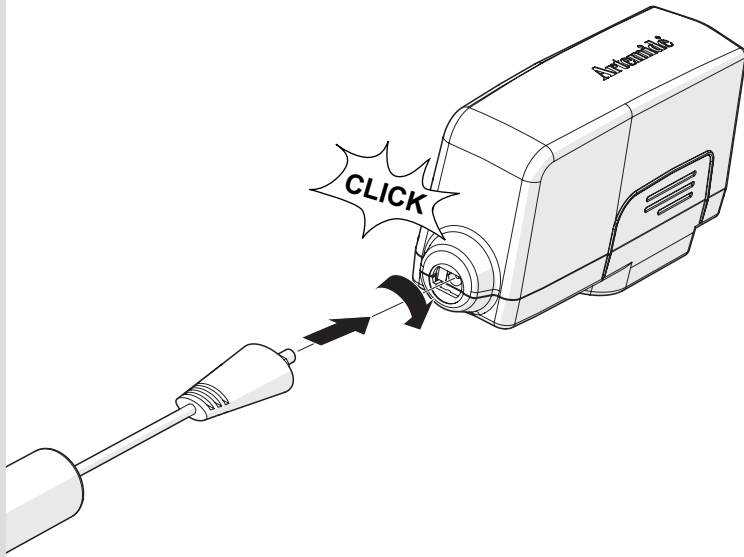



i

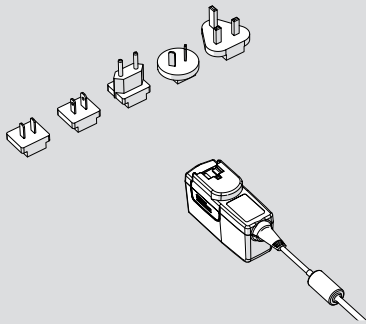

2

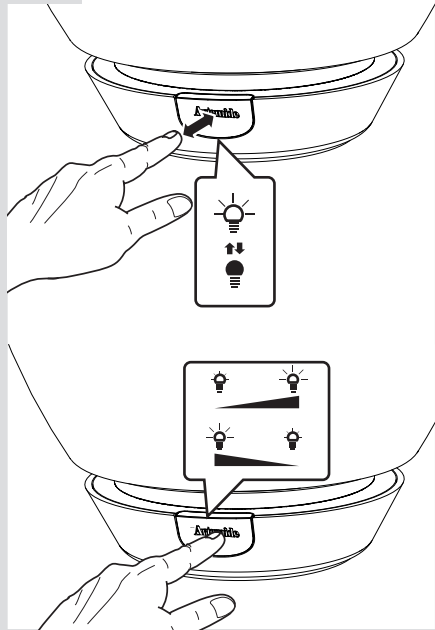

1

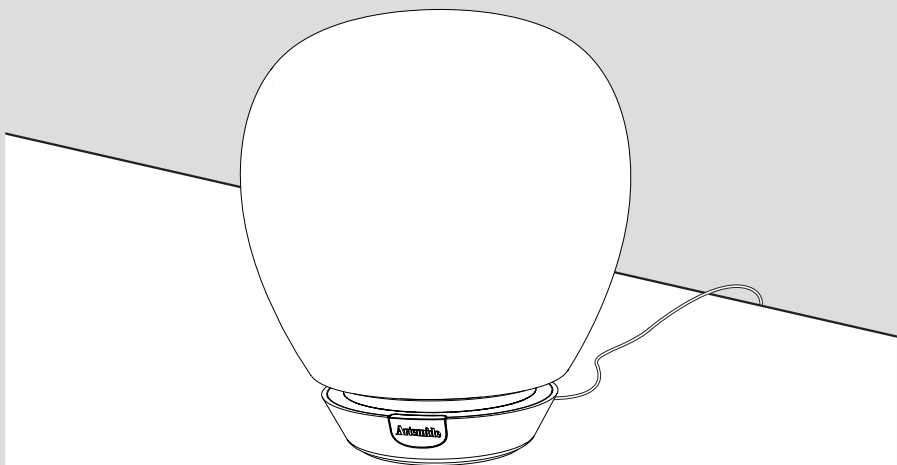
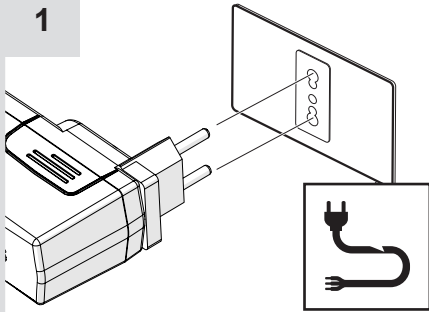

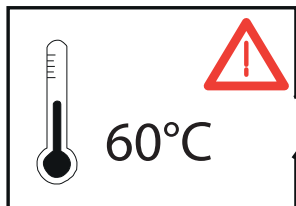
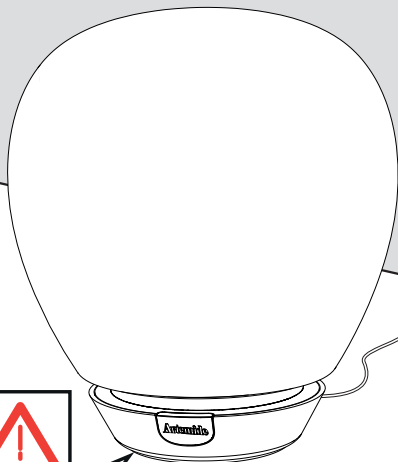

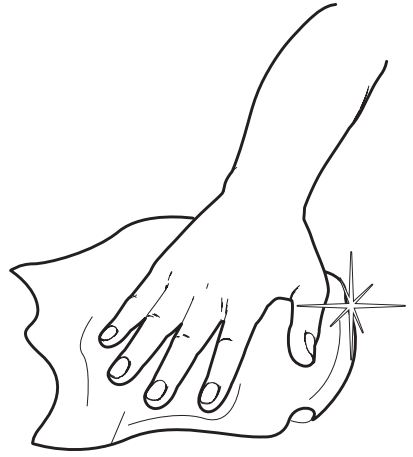
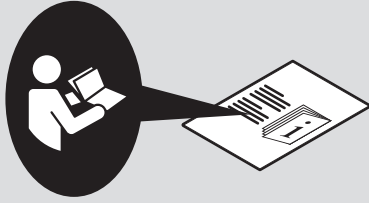

Artemide®



Artemide

via Bergamo, 18
20010 Pregnana M.se (MI)
ITALIA

tel. +39 02 935 181
fax +39 02 935 90 254
fax +39 02 935 90 496

www.artemide.com

VAT IT00846890150

cod. Y513000182C