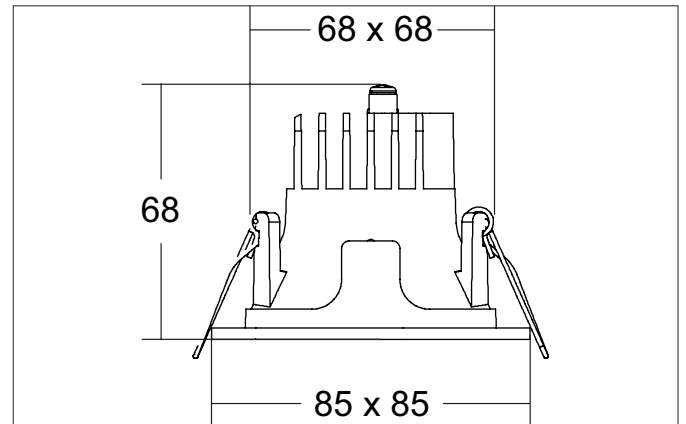

APOLLO MICRO LED downlight, square, DALI
Article no. 41641185DALight.
For Generations.**Tender**

LED downlight, square, DALI, Square. Toolless ceiling installation by installation springs. Ceiling cut-out L x W 68 x 68 mm, Installation depth 68 mm, Length 85 mm, Width 85 mm, Reflector silver with rotationssymmetrical, deep, wide distributed light intensity. optimal light distribution due to a plastic, transparent cover. Luminous flux 791 lm, Power 1 x 6,4 W, Light colour neutral white, Correlated color temperature (CCT) 3.500 K, Colour rendering index CRI > 90, Rated life time L80/B10 at 25 °C: 50.000 h, Rated life time L80/B50 at 25 °C: 50.000 h, Housing material: Aluminium / Glass / Plastic, Colour: Black structure, Permissible ambient temperature (ta): -20 °C - +25 °C, Protection class (EN 61140): II, Degree of protection (DIN EN 60529): IP20, .With electronic driver, DALI dimmable.

Article data	
Article no.	41641185DA
GTIN	4251433990291
Series name	APOLLO MICRO
Short description	LED downlight, square, DALI
Material	Aluminium / Glass / Plastic
Colour	Black
Type of surface	Structure
Shape	Square
Built-in width	68 mm
Built-in length	68 mm
Installation depth	68 mm
Length	85 mm
Width	85 mm
Weight	0.200 kg

APOLLO MICRO LED downlight, square, DALI

Article no. 41641185DA

Light.
For Generations.

Lighting technology	
Colour temperature	3.500 K
Light colour	White
Light output	Direct
Luminous flux	791 lm
System efficiency	124 lm/W
Colour rendering	CRI > 90
Reflector	Faceted
Reflektorfarbe	silver
Beam angle	55°
Light sharing	Symmetric
Adjustable color temperature	

Operating technology of the luminaire	
Voltage type	AC
AC nominal voltage max	230 V
Frequenz max.	50 Hz
Lamp	LED
Lamp holder	LED
Protection class	II
Degree of protection	IP20
Control	DALI
Bulb change possible	The light source of this luminaire may only be replaced by the manufacturer or a service technician commissioned by him or a similarly qualified person.
Rated life time L80/B50 at 25 °C	50.000 h

Mounting technology	
Mounting method	Recessed mounting
Place of installation	Ceiling-mounted
Adjustability	Not adjustable
Further references	No cover with thermal insulation material
Material cover	Plastic, transparent
Suitable for through-wiring	No

Packing data	
Gross weight	0.25 kg
Length of packaging	85 mm
Packaging width	85 mm
Packaging height	66 mm
Disposal at end of life	This product must not be disposed of with household waste. You are obliged, to dispose of such electrical waste separately. By disposing of electrical waste and other old or defective electronics separately, you support recycling or other forms of re-use. In that way you help to take care and to avoid that harmful substances get into the environment.

Accessories	