

LITA

design David Dolcini

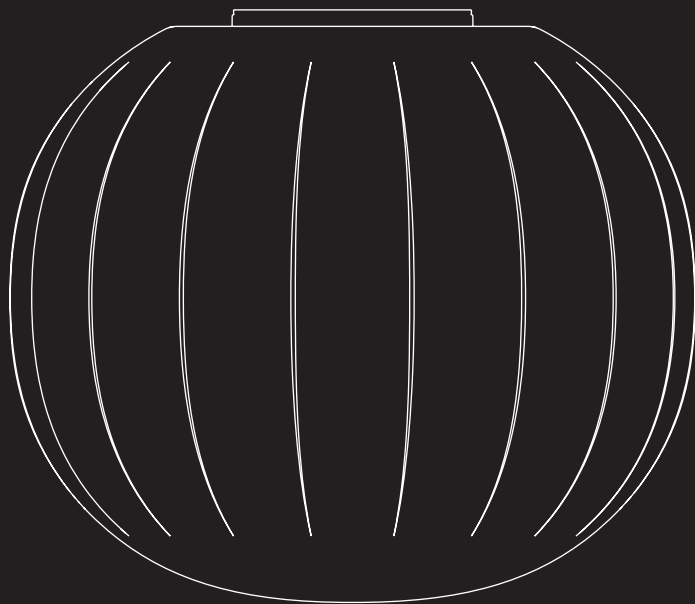

**LUCE
PLAN**

D92



D92P14

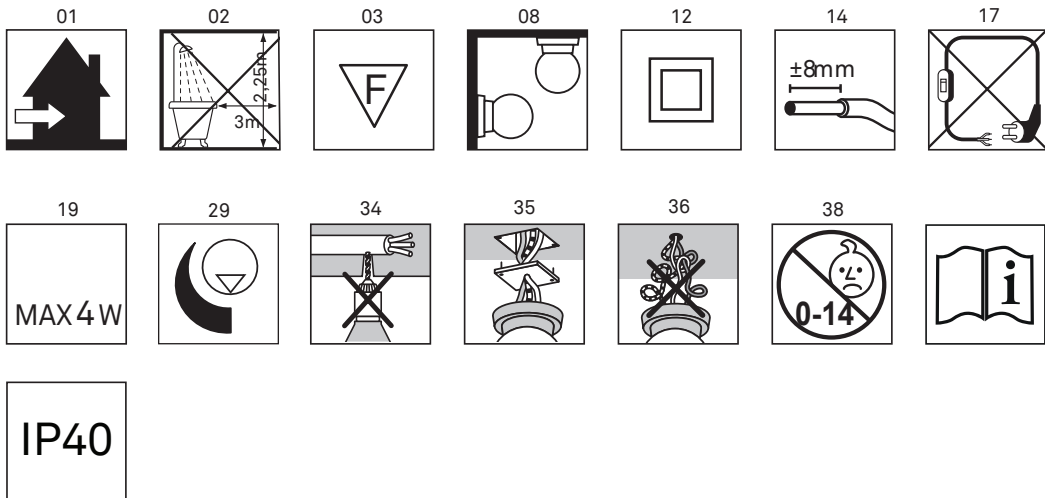

D92P18

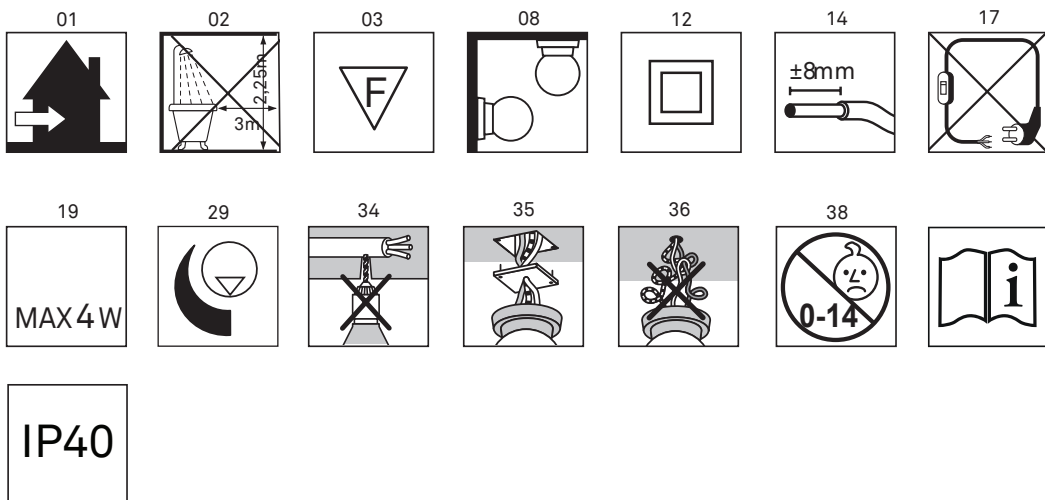

D92P30

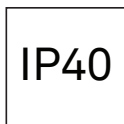
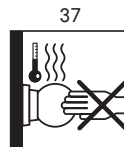
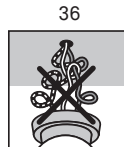
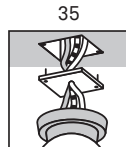
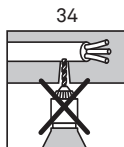
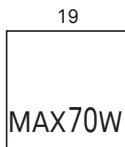
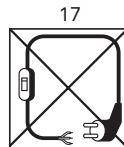
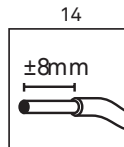
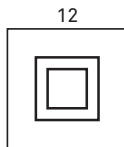
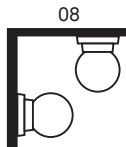
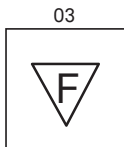
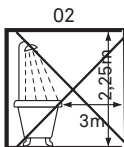
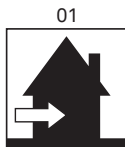

D92P14

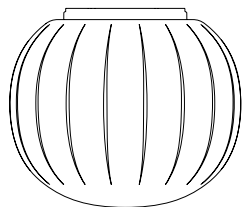

12 cm
4.7"

14 cm

5.5"

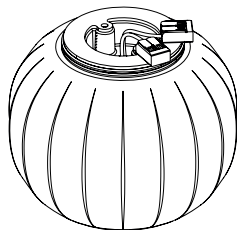

x1



a



b

IP40

kg 0,6 kg

lb 1.3 lb

D92P18+D92/2

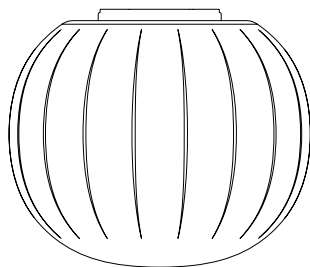

15 cm
5.9"

18 cm

7"

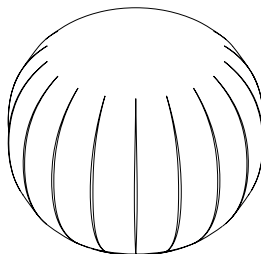

x1

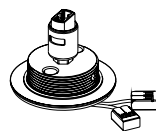

x1



a



b

kg 0,8 kg

lb 1.7 lb

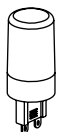

MAX
4W
LED
G9

D92P30+D92/3



a



b

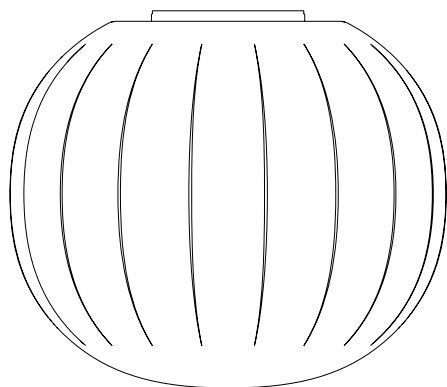

26 cm

10"

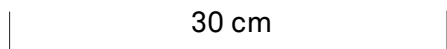

30 cm

11.8"

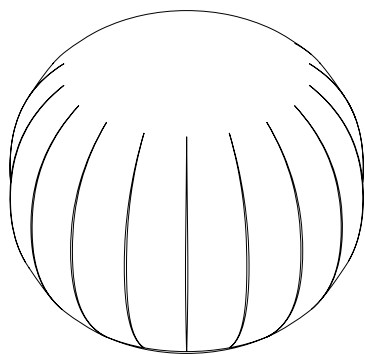

x1

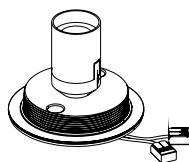

x1

kg 2,2 kg

lb 4.8 lb



MAX
16W
LED
E27



MAX
70W
E27

D92P14

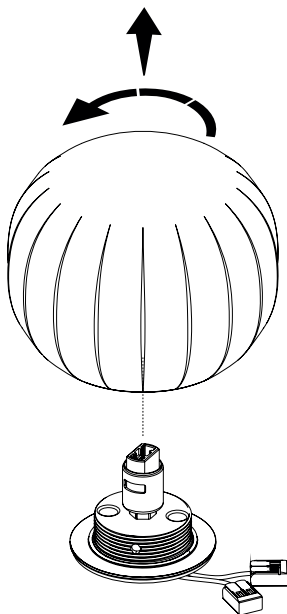

1

D92P14 - D92P18 - D92P30

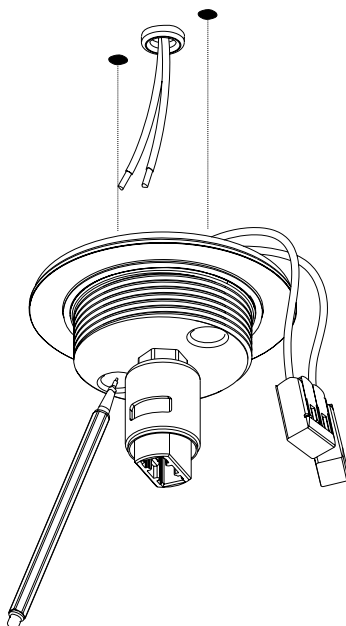

1.1

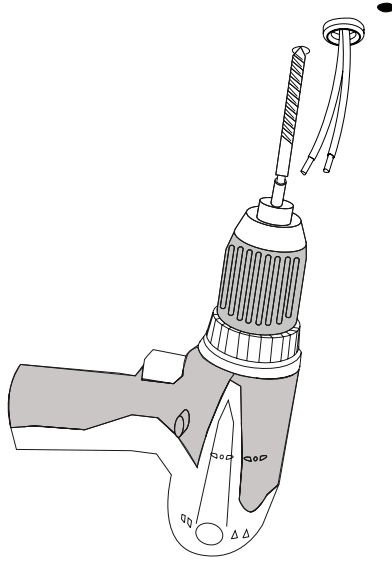
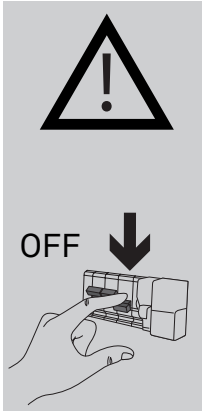

1.2

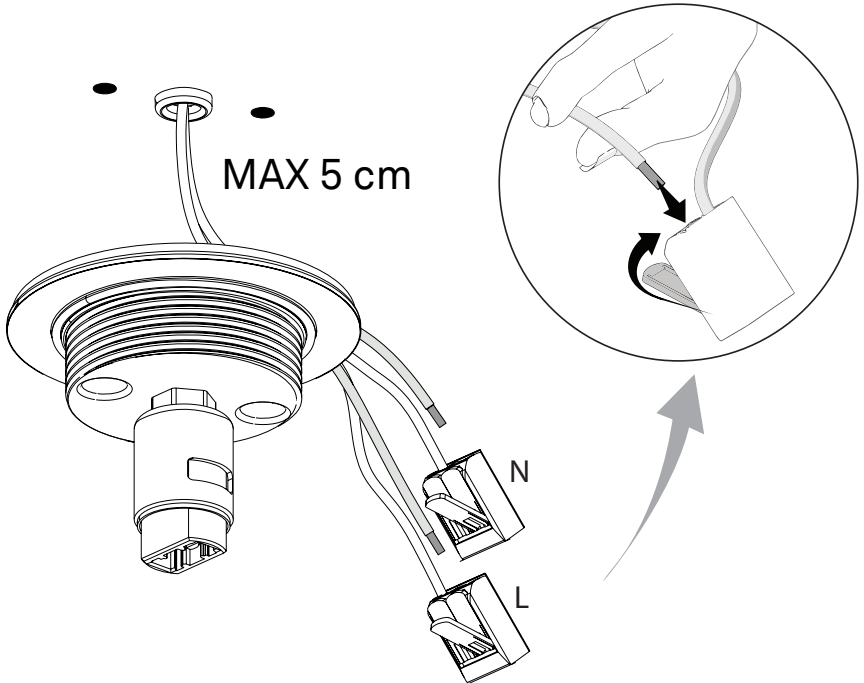

1.3

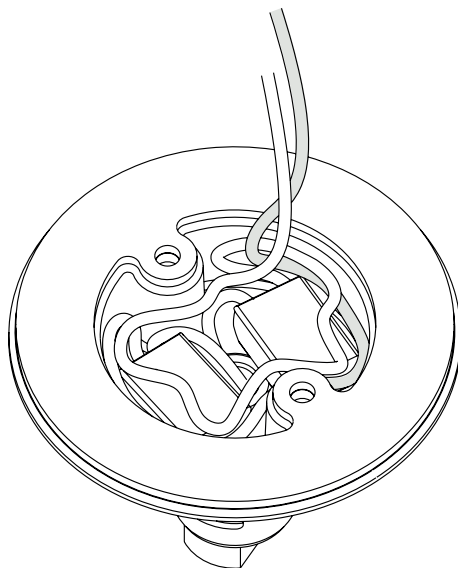

1.4

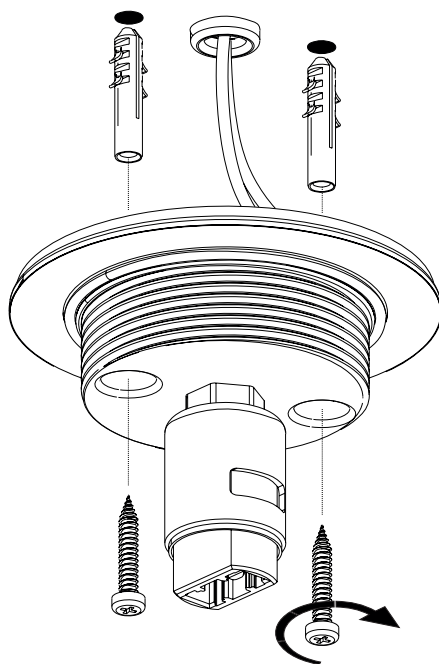

2

D92P14 - D92P18

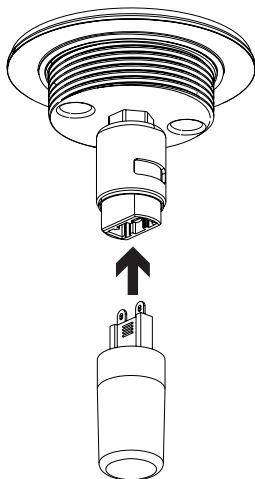

D92P30

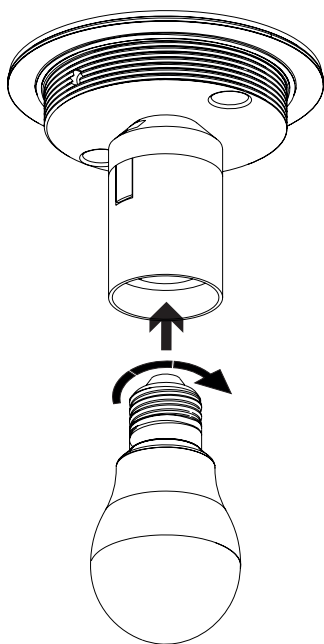

2.1 D92P14 - D92P18

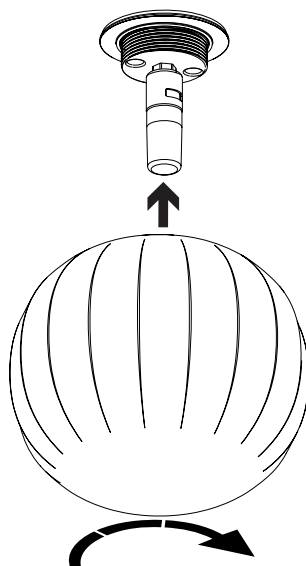

D92P30

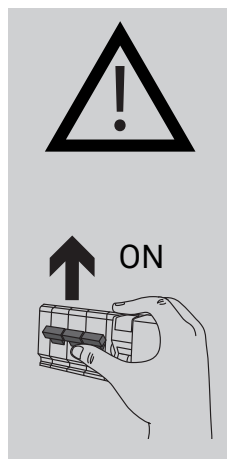
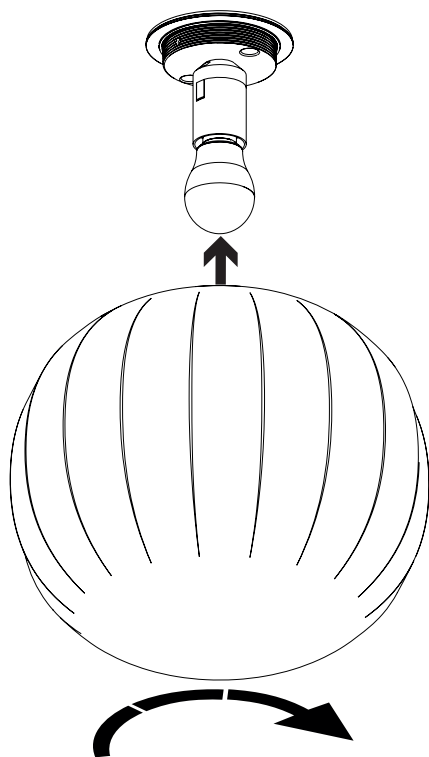

3

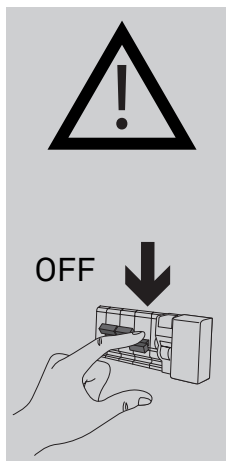

1.

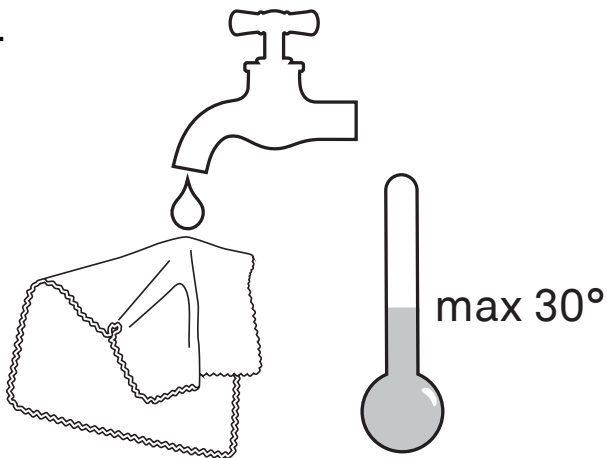

2.



3.

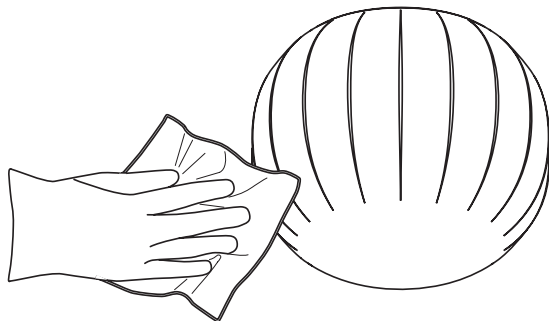



www.luceplan.com

D920I0001