

# BULBULLIA

design Francisco Gomez Paz

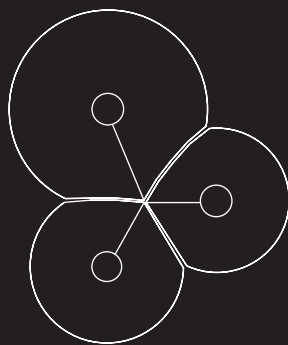
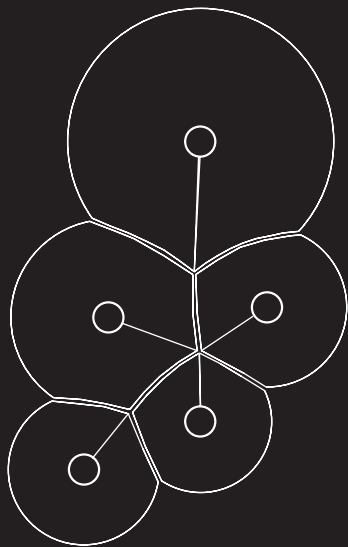

**LUCE  
PLAN**

D95



D95

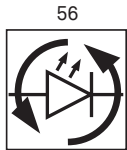
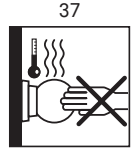
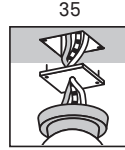
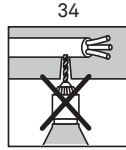
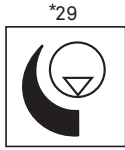
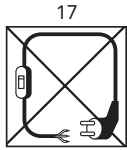
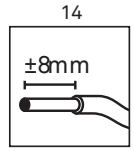
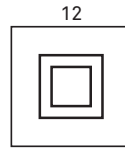
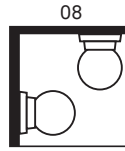
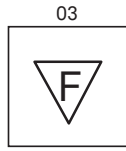
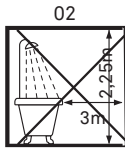

\* D95A5 + D95A3: Wall mounted Trailing Edge dimmers – see datasheet [www.luceplan.com](http://www.luceplan.com)

# D95A5 - D95A5D

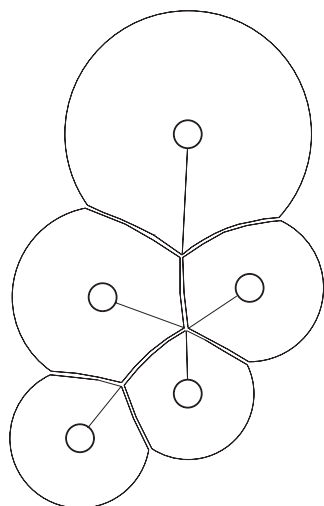

37 cm

14.5"

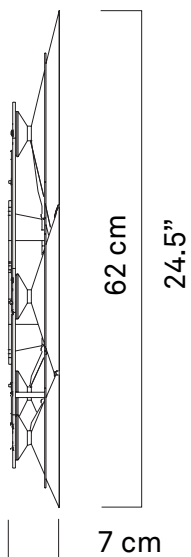

62 cm

24.5"

7 cm

2.7"

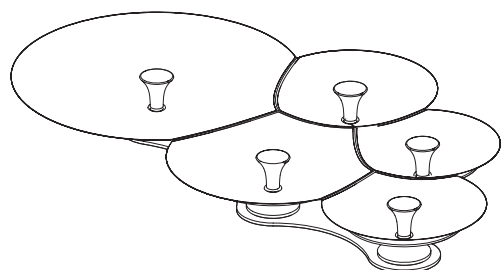

x1

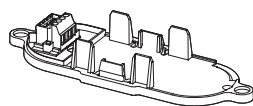

x1



x5

kg 1,1 kg

lb 2,4 lb

D95A3 - D95A3D



a



b

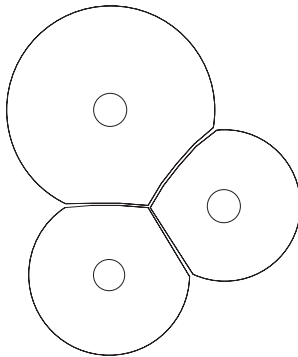

31 cm

12.2"

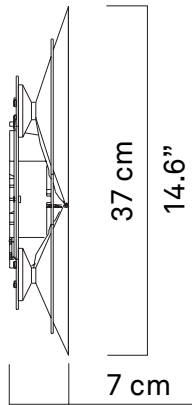

37 cm

14.6"

7 cm

2.7"

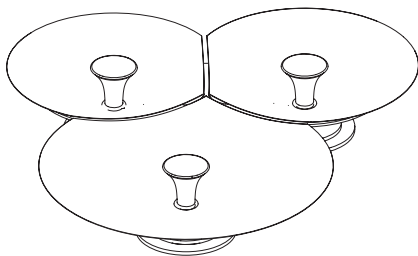

x1

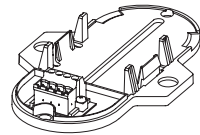

x1



x3

**kg** 0,7 kg

**lb** 1,5 lb

# 1 | 1.1 D95A5 - D95A5D

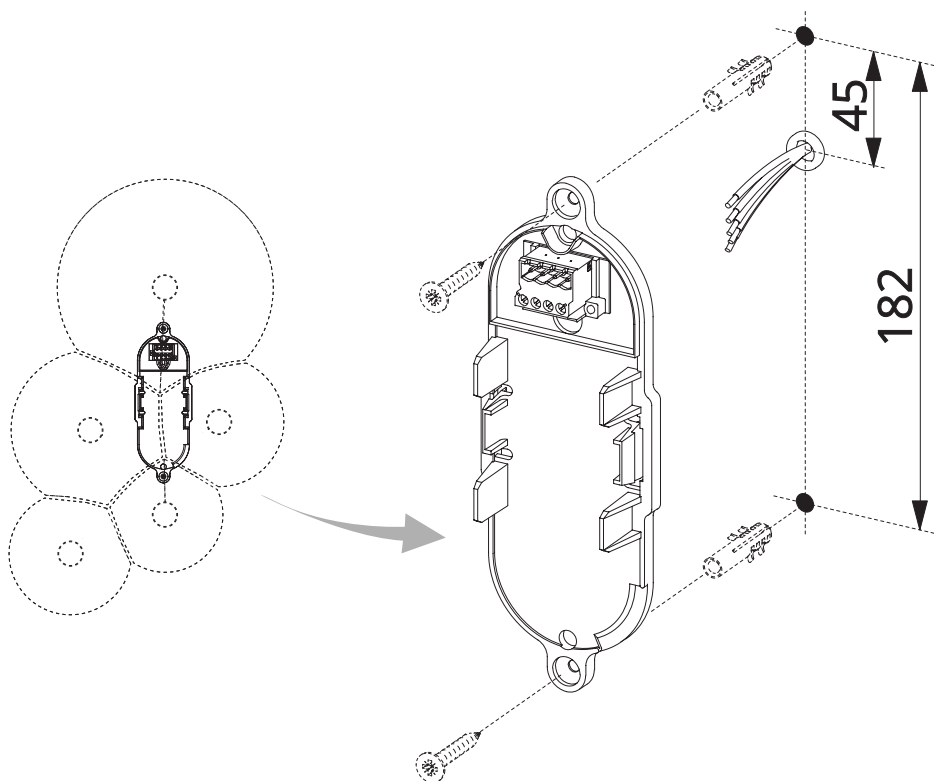
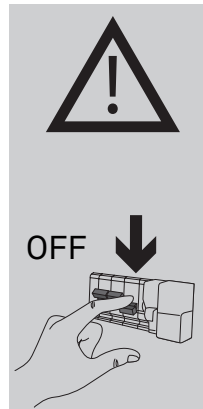
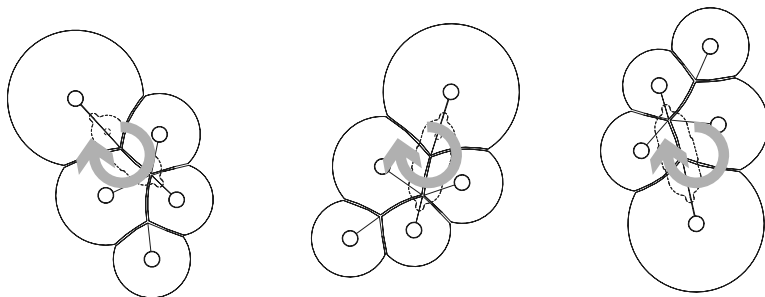

D95A3 - D95A3D

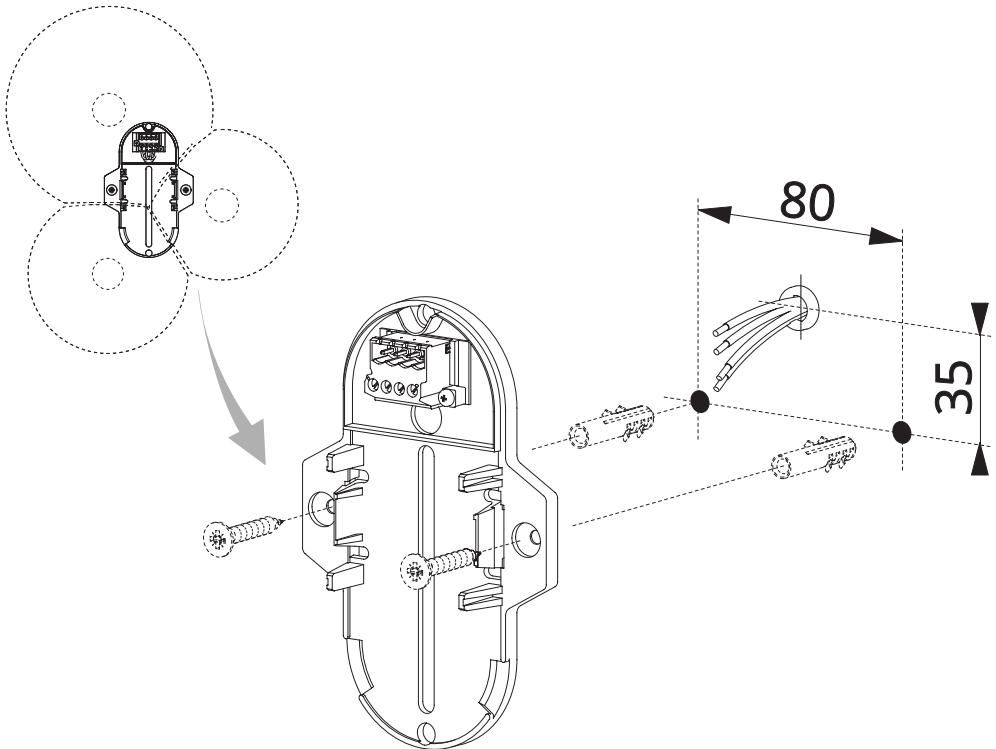
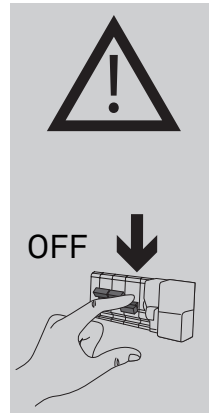
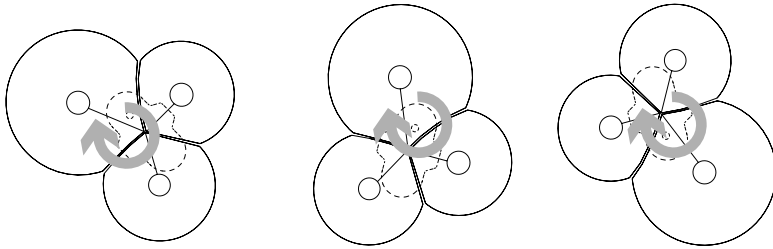

# 1.2 D95A5 - D95A3

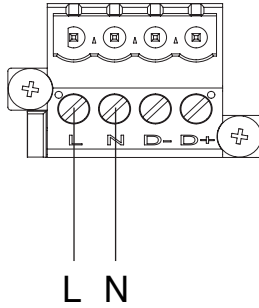
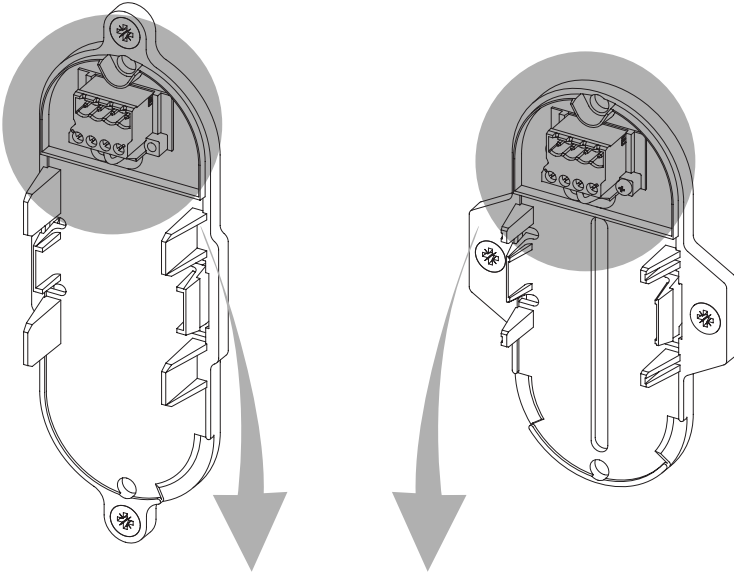

## TRAILING EDGE



# D95A5D - D95A3D

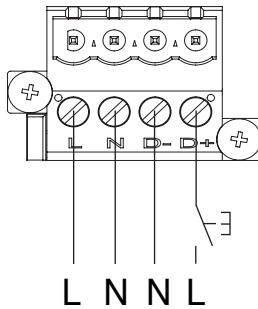
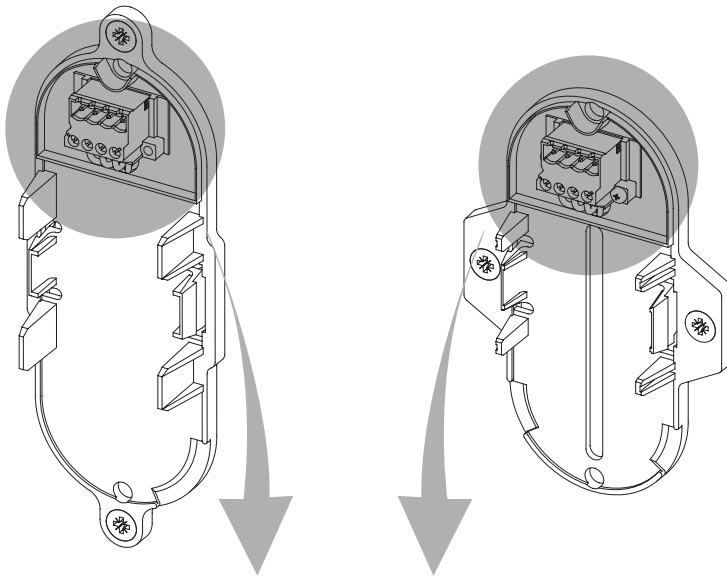

PUSH DIM





# D95A5D - D95A3D

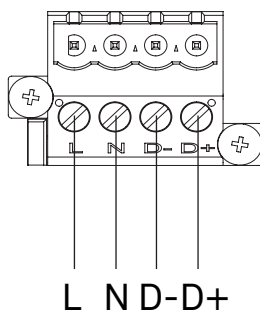
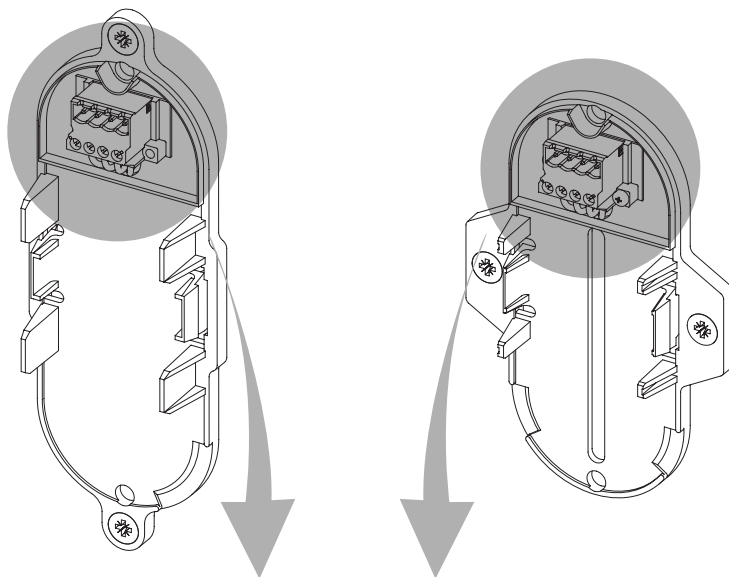

# 1.3

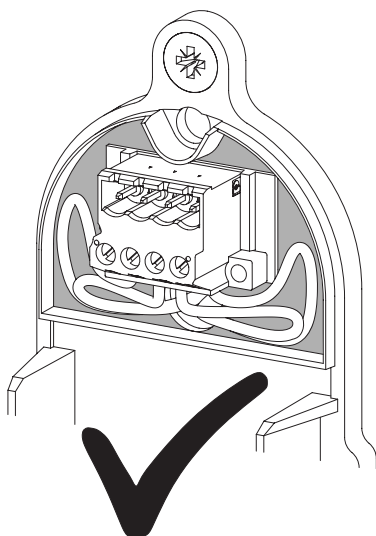
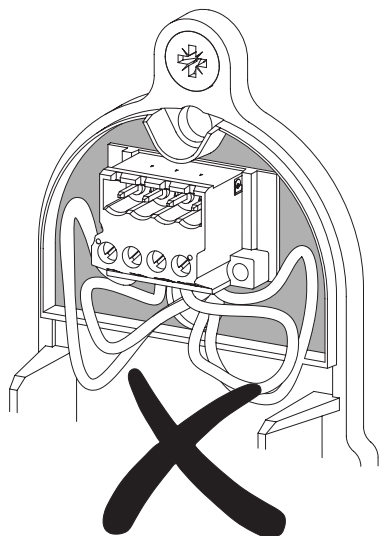

# 2 D95A5 - D95A5D

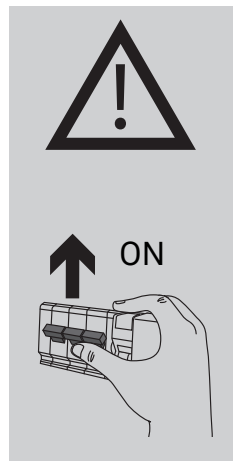
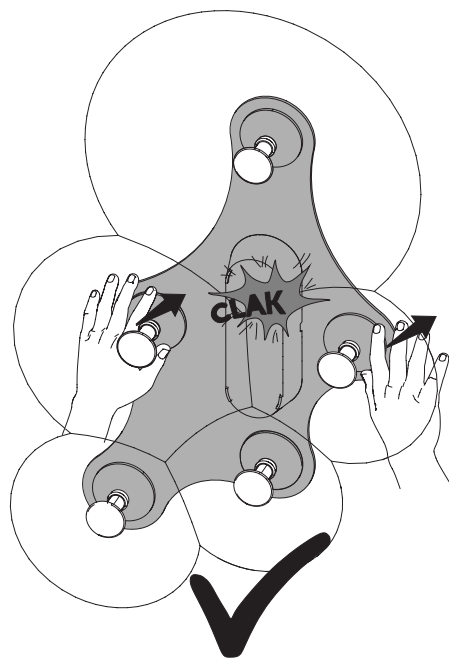
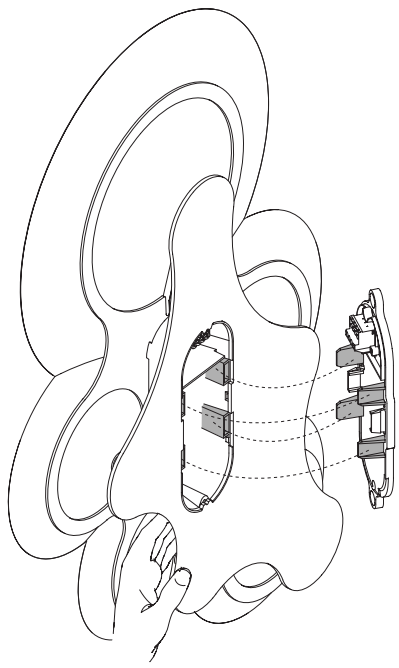
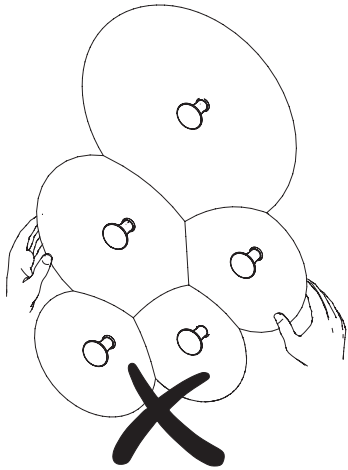

D95A3 - D95A3D

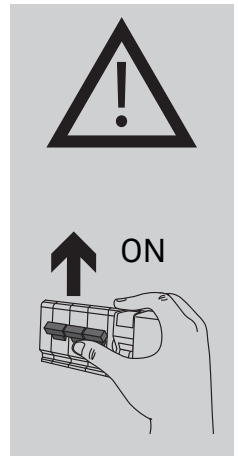
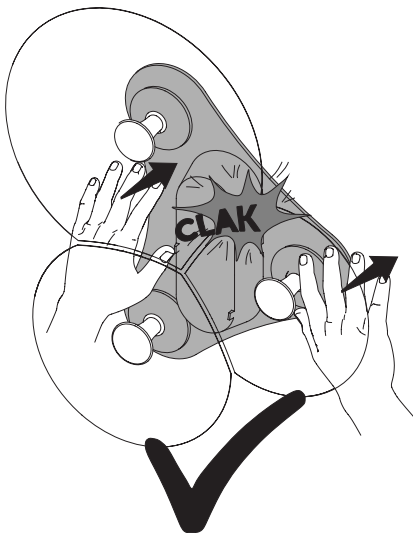
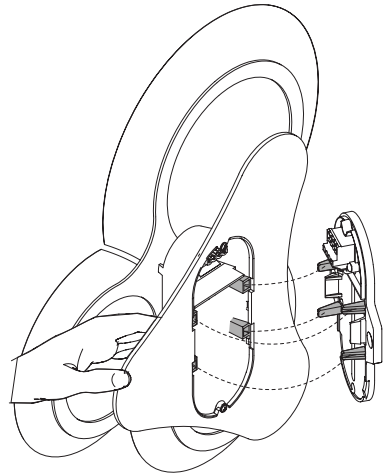
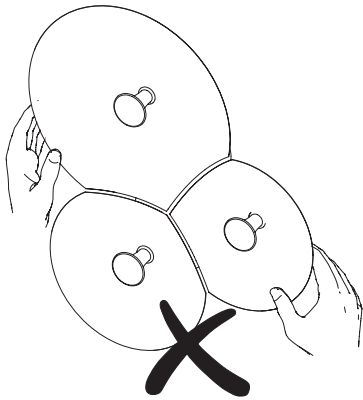

# 3 D95A5 - D95A5D

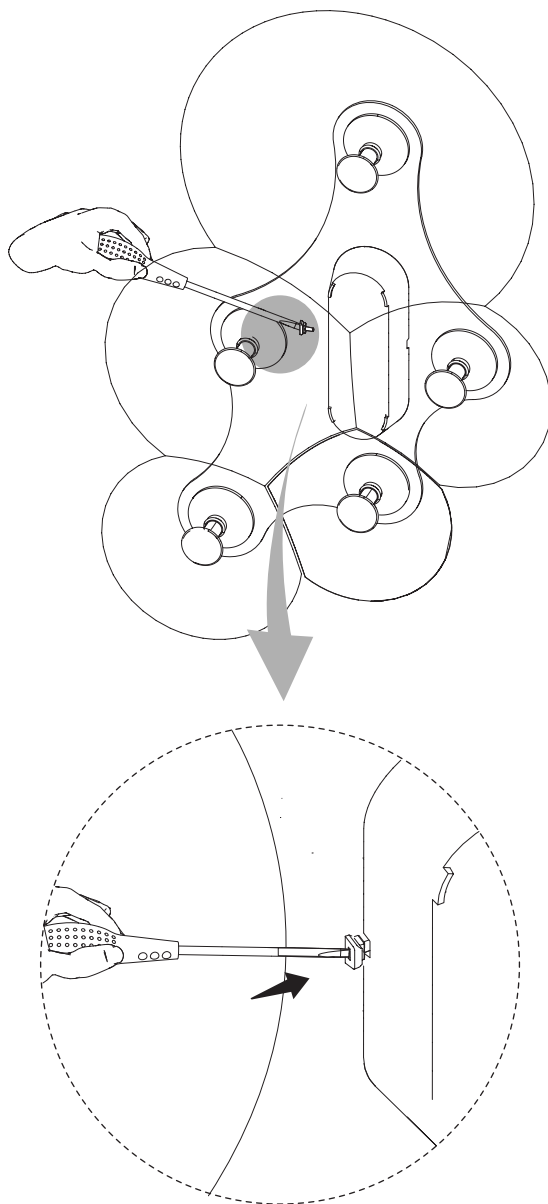

D95A3 - D95A3D

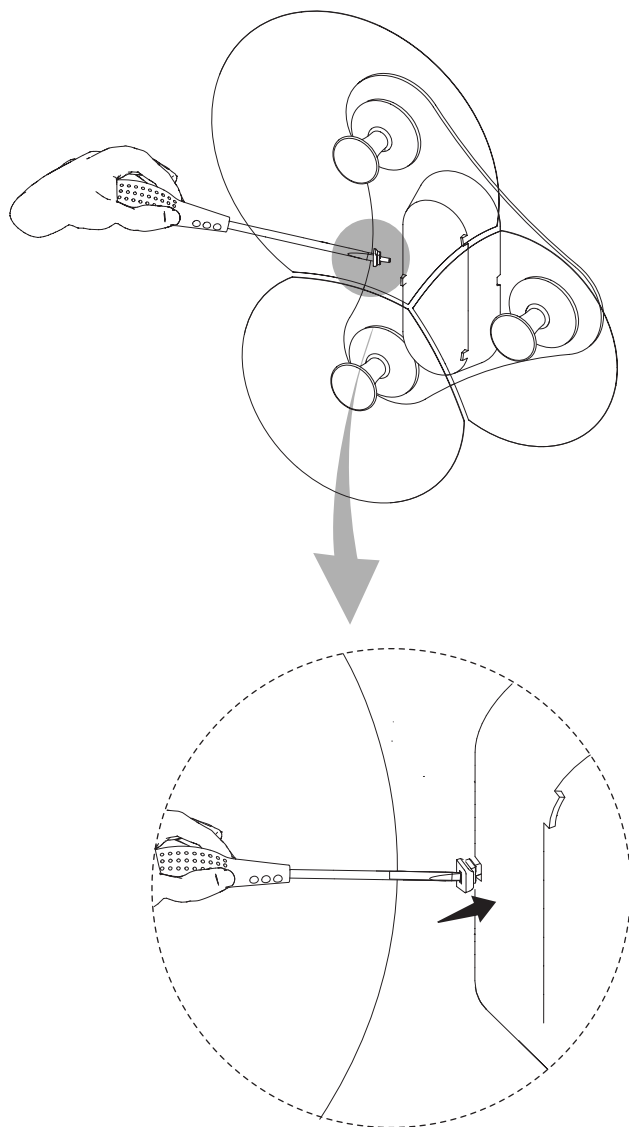



# D95A5 - D95A5D

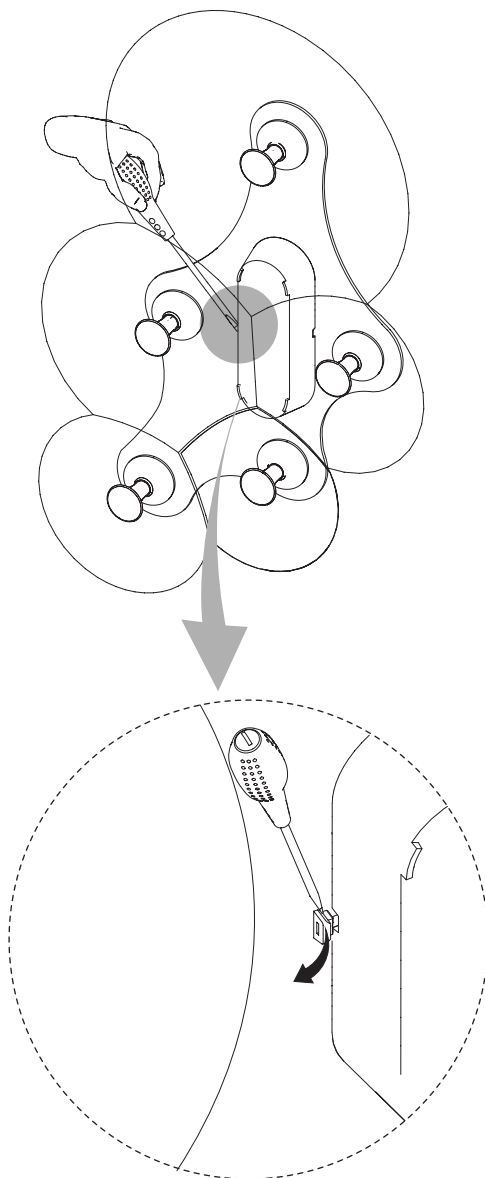
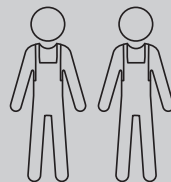

D95A5 - D95A5D

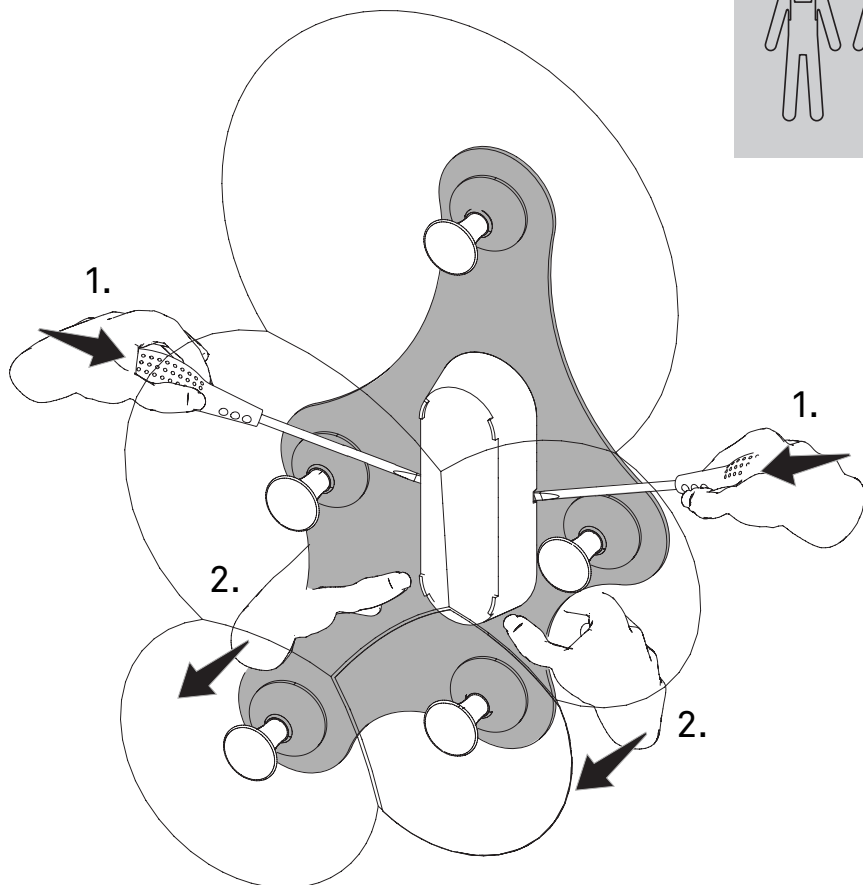





## D95A3 - D95A3D

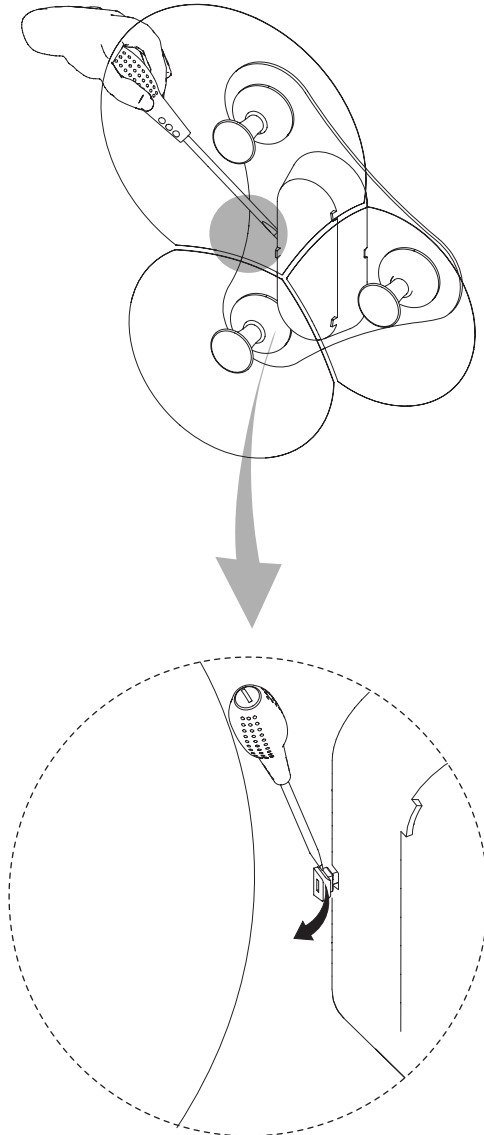
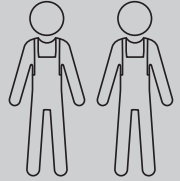

D95A3 - D95A3D

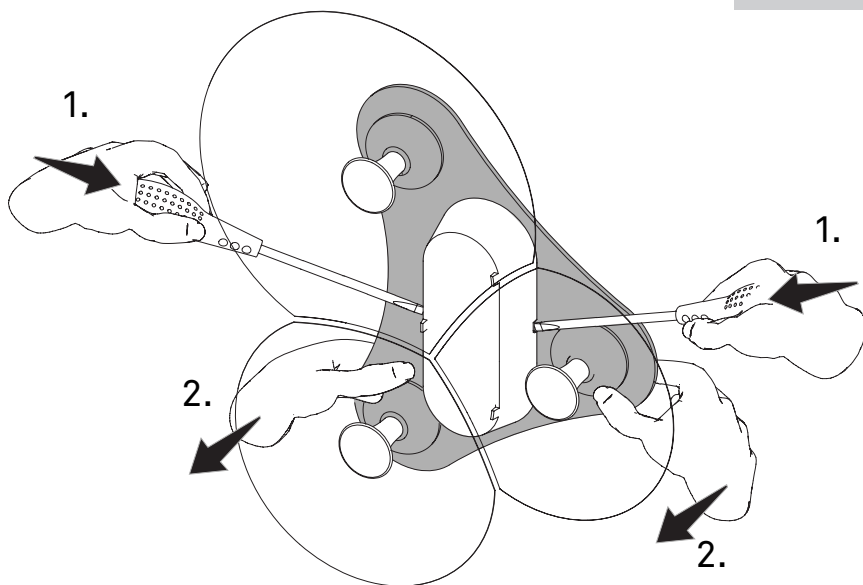
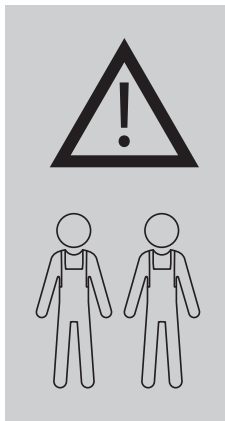

# 4

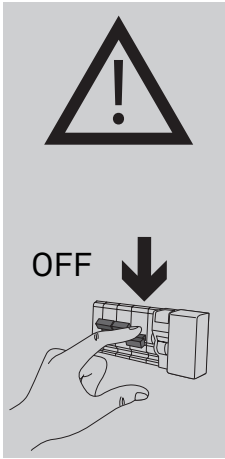

1.

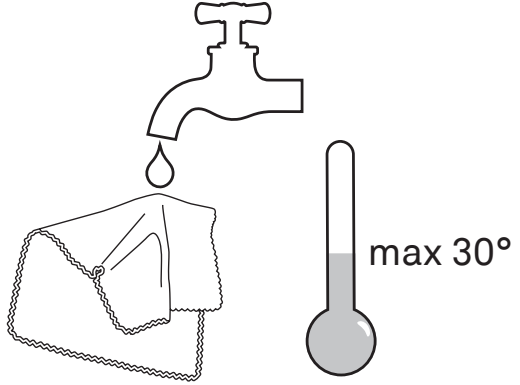

2.



3.

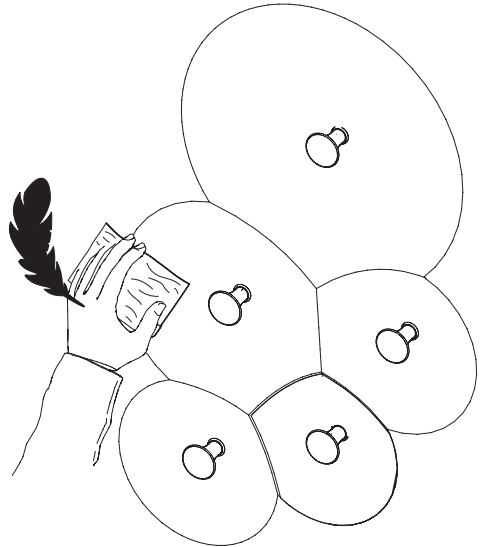



[www.luceplan.com](http://www.luceplan.com)

D950IA001