

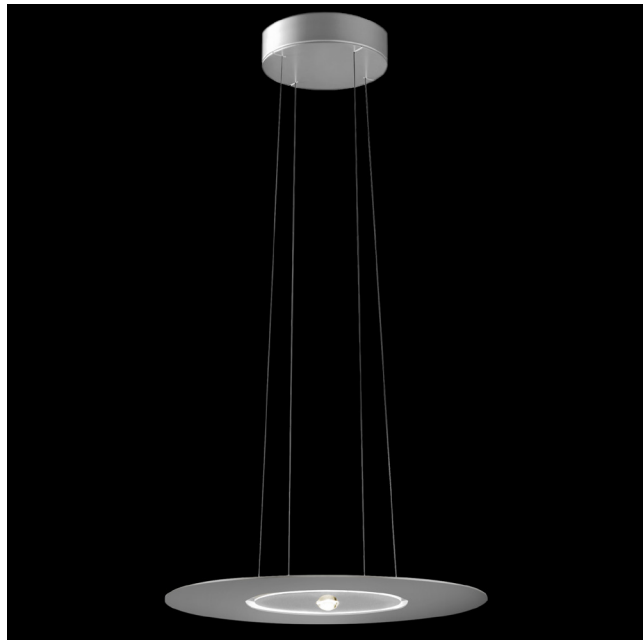

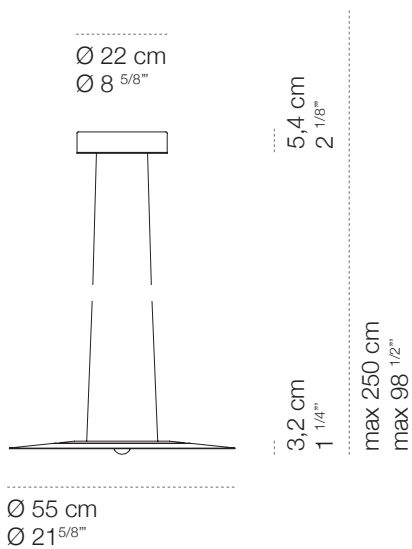

Passepartout55 sopratavolo









luminaire	
materials	aluminium, steel
environment	interiors
mounting location	ceiling
emission	indirect and direct light
weight	6,3 kg
tension	230V
ballast	2 x dimmable electronic integrated
dimming	phase-cut / casambi integrated
insulation class	1
IP classification	IP20
certifications	CE
design	Luta Bettonica, 2017

lower emission	
source	LED
number of led	1
power	13W
luminous flux	1.300 lm
colour temperature	2.800K
CRI	92

upper emission	
source	LED
number of led	42
power	16W
luminous flux	1.500 lm
colour temperature	2.800K
CRI	90

finish / codes		
		
matt white cod 1184 cod C1184	matt black cod 1185 cod C1185	polished chrome cod 1180 cod C1180
phase-cut dimmable casambi integrated		

		
polished gold cod 1181 cod C1181	matt silver cod 1182 cod C1182	matt gold cod 1183 cod C1183
phase-cut dimmable casambi integrated		

versions			
			
Passepartout parete	Passepartout terra	Passepartout55 sopratavolo	Passepartout25 sopratavolo

CINI & NILS