

Artemide®

Cabildo

design
E. Solè

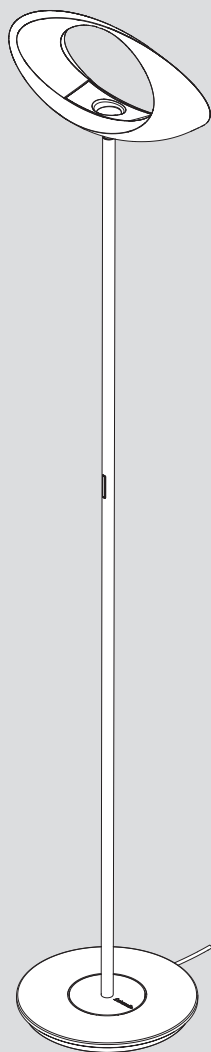



i

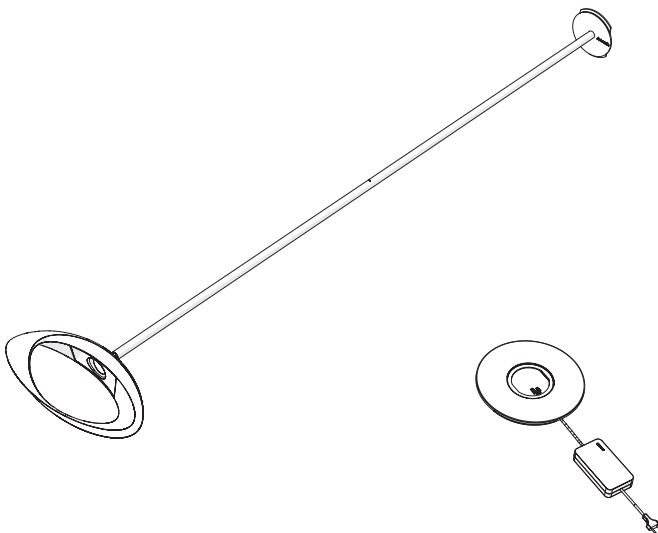
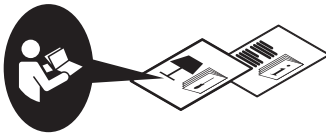
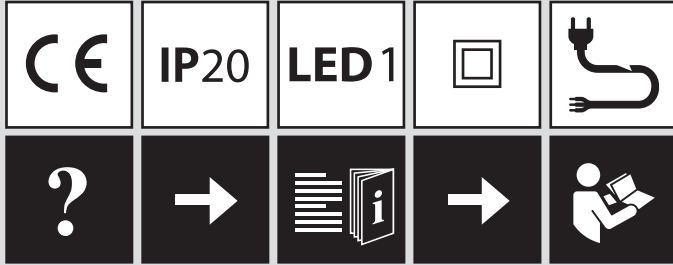

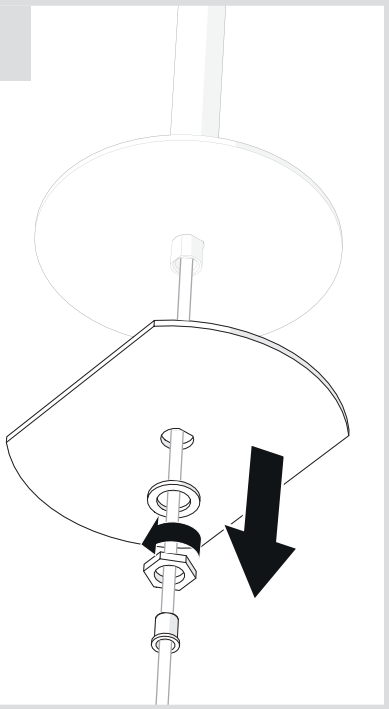
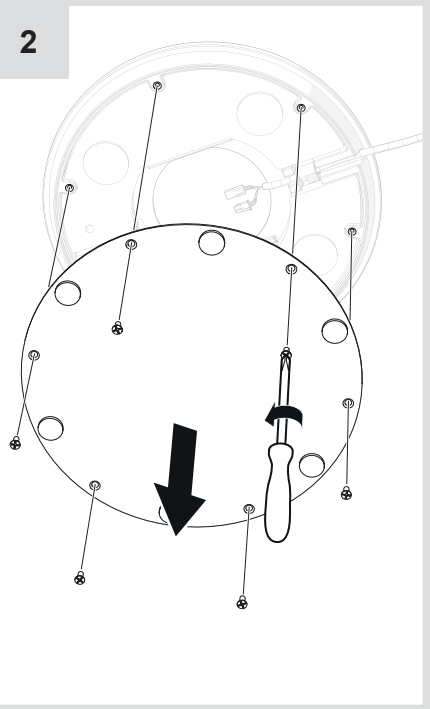
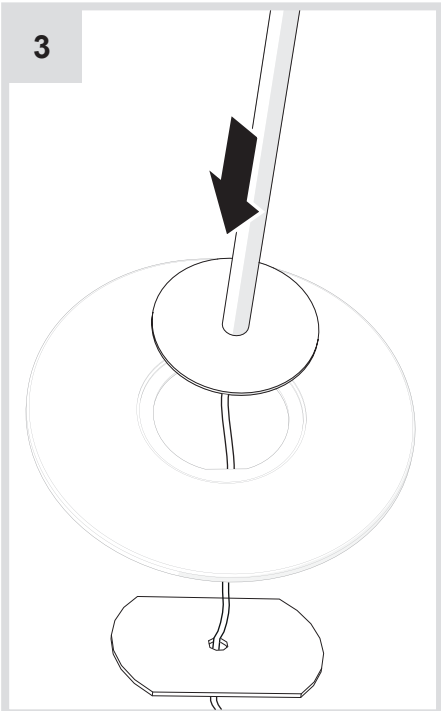
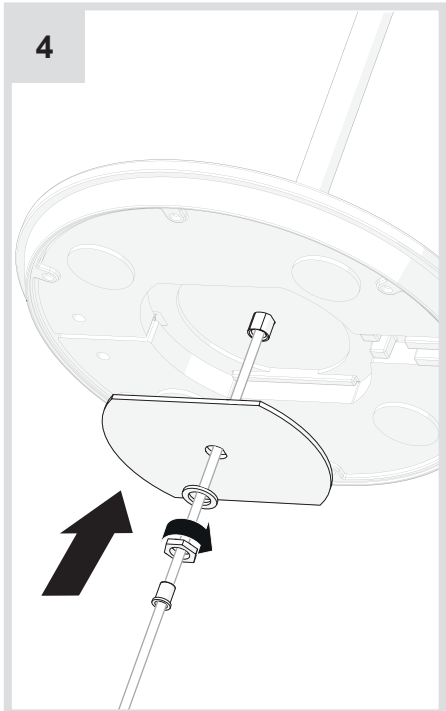
1**2****3****4**

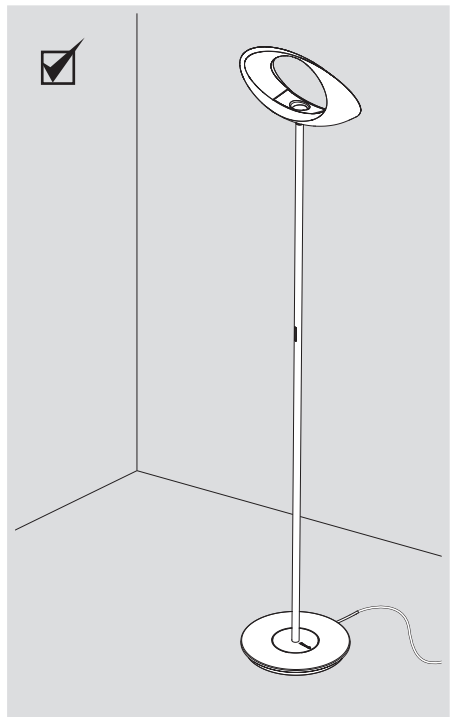
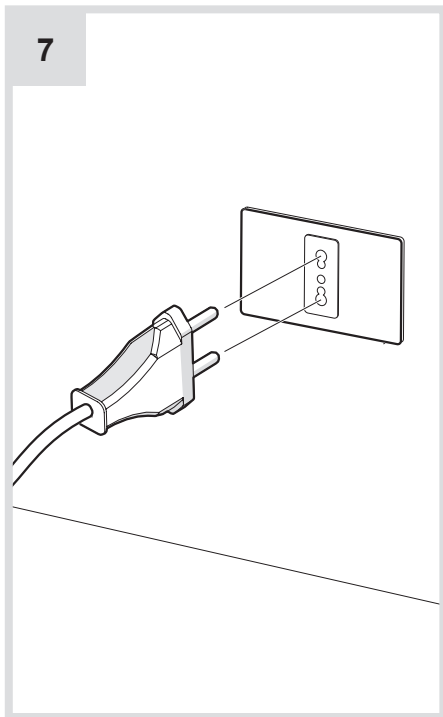
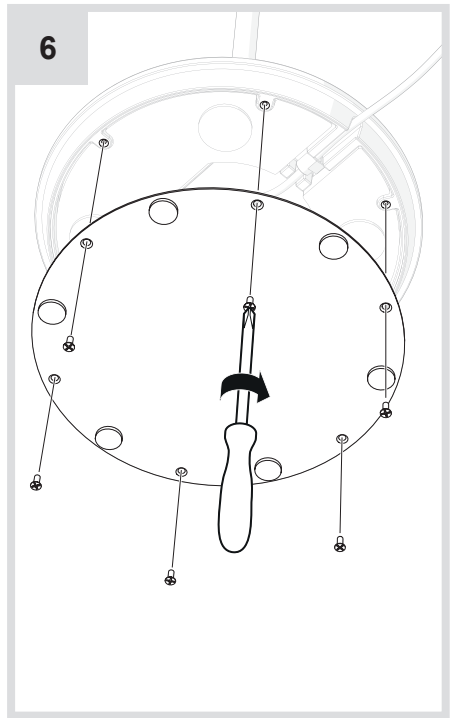
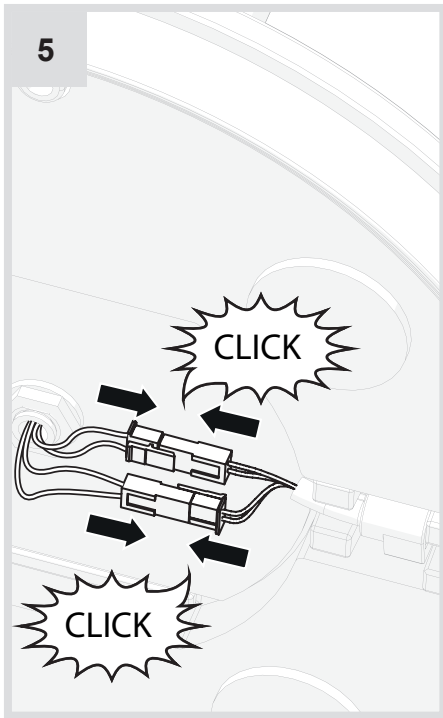



i

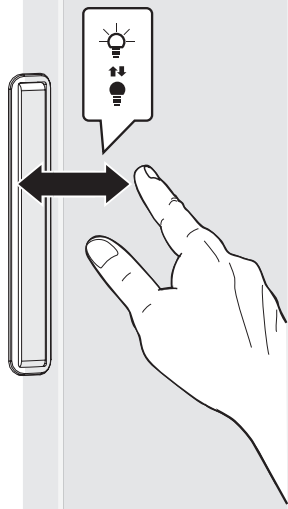

i

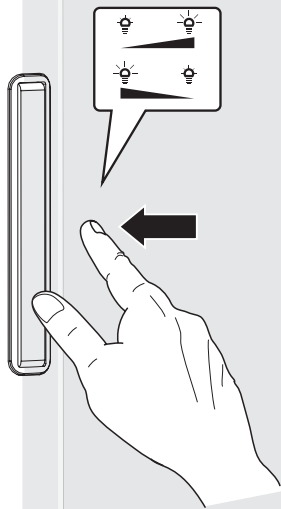

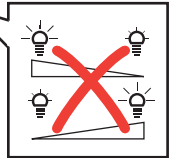
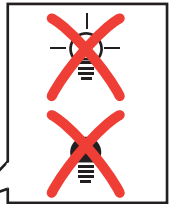
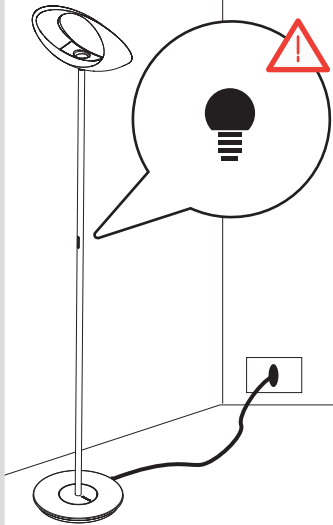
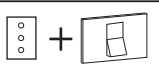
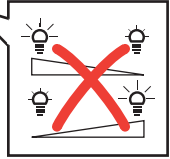
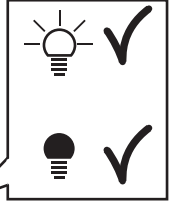
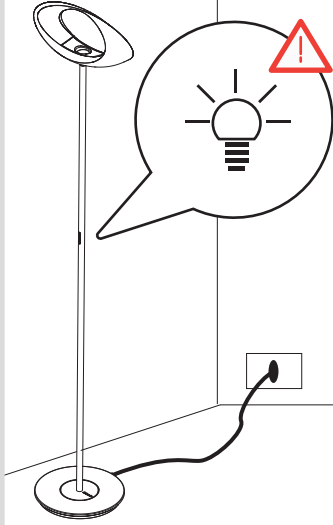
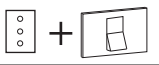

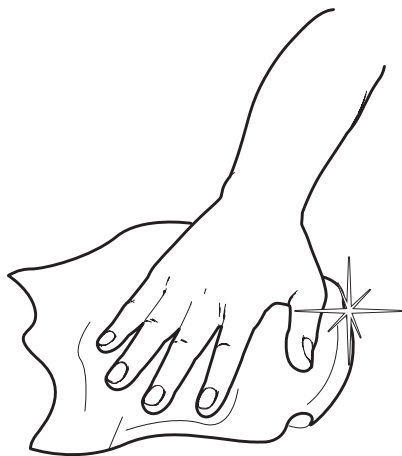
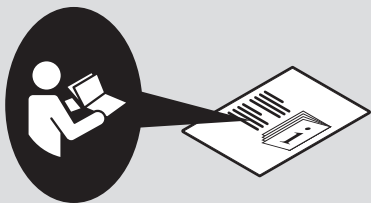

Artemide®

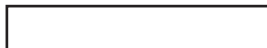

Artemide

via Bergamo, 18
20010 Pregnana M.se (MI)
ITALIA

tel. +39 02 935 181
fax +39 02 935 90 254
fax +39 02 935 90 496

www.artemide.com

VAT IT00846890150

cod. Y513000427