

Artikel Nr.: 342132

Pendelleuchte, Asterope rund 250, schwarz, 220-240V AC/50-60Hz, 1x max. 40,00 W

Technische Daten

Charakteristik

Material	Metall
Farbe	schwarz
Optik	matt
im Lieferumfang	



Elektrische Daten

Leistung	1x max. 40,00 W
Eingangsspannung	220-240V AC/50-60Hz
Eingangsstrom	
Fassung / Sockel	E27
Anzahl Sockel	1
Netzgerät	
Ansteuerung	dimmbar über optionales Leuchtmittel
Anschlussmöglichkeit	Klemme
Schutzklasse I, II, III	I



Artikel Nr.: 342132

Pendelleuchte, Asterope rund 250, schwarz, 220-240V AC/50-60Hz, 1x max. 40,00 W

Lichtrichtung

Dreh- und Schwenkbereich	
Neigungswinkel	
Abstrahlverhalten	
Reflektor / Linse	

Abmessungen und Gewicht

Länge	1400 mm
Breite	
Höhe	
Durchmesser	250 mm
Deckenabhängung	1155 mm
Gewicht	1050 g

Sockelmaß

Länge	
Breite	
Höhe	25 mm
Durchmesser	120 mm

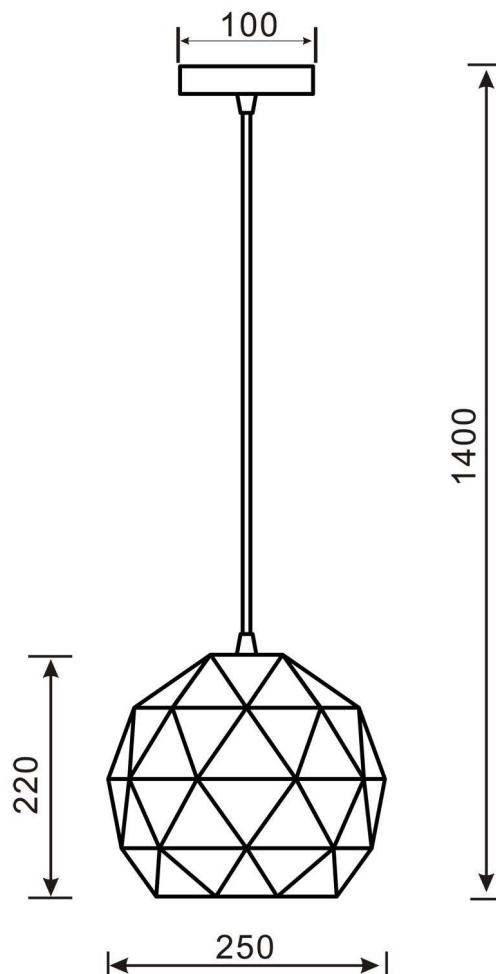

Artikel Nr.: 342132

Pendelleuchte, Asterope rund 250, schwarz, 220-240V AC/50-60Hz, 1x max. 40,00 W

Grenzwerte

Betriebstemperatur	-5°C - +40°C
Lagertemperatur	-10°C - +60°C
IP - Schutzart	IP20

EEL	Die Leuchte ist geeignet für Leuchtmittel der Energieeffizienzklassen A++ bis E
IP20	Schutz gegen das Eindringen von Fremdkörper > 50 mm. Kein Schutz gegen das Eindringen von Wasser.
	Leuchte der Schutzklasse I bei der der Schutz gegen elektrischen Schlag nicht allein auf der Basisisolierung beruht, sondern die eine zusätzliche Sicherheitsvorkehrung derart enthält, dass berührbare leitfähige Teile mit Mitteln zum Anschluss an den Schutzleiter der festen Installation ausgerüstet sind, so dass im Fehlerfall der Basisisolierung berührbare leitfähige Teile nicht aktiv werden können.

Article no.: 342132

Pendant lamp, Asterope round 250, matt black, 220-240V AC/50-60Hz, 1x max. 40,00 W

Technical Data**General Characteristics**

Material	metal
Colour	matt black
Optics	
included in delivery	

**Electrical Characteristics**

Power	1x max. 40,00 W
Input voltage	220-240V AC/50-60Hz
Input current	
Base (standard designation)	E27
Number of bases	1
Power supply unit	
Electronically reversible	dimnable via optional bulb
Connection possibility	clamp
Protection class I, II, III	I



Article no.: 342132

Pendant lamp, Asterope round 250, matt black, 220-240V AC/50-60Hz, 1x max. 40,00 W

Light Direction

Rotating and tilting range	
Angle of inclination	
Radiation direction	
Reflector / lense	

Dimensions & Weight

Length	1400 mm
Width	
Height	
Diameter	250 mm
Suspensions from ceiling	1155 mm
Product Weight	1050 g

Base dimensions

Length	
Width	
Height	25 mm
Diameter	120 mm

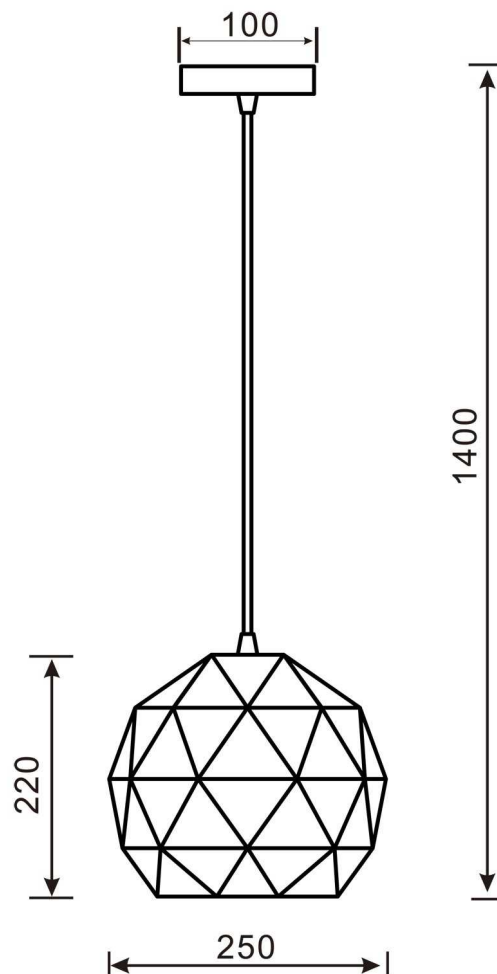

Article no.: 342132

Pendant lamp, Asterope round 250, matt black, 220-240V AC/50-60Hz, 1x max. 40,00 W

Absolute maximum ratings

Working temperature	-5°C - +40°C
Storage temperature	-10°C - +60°C
IP - Code	IP20

EEl	The luminaire is suitable for lamps of energy efficiency classes A++ to E.
------------	--

IP20	Protection against penetration of foreign objects > 50 mm. No protection against penetration of water.
-------------	--



Lightings of Protection Class I in which the protection against electric shock is not based solely on isolation, but an additional safety measure contains such a way that accessible conductive parts are equipped with means for connection to the protective conductor of the fixed installation, so that in case of failure of the basic insulation exposed conductive parts cannot be active.
