

## 9621547

12W LED / 12W Total  
incl. LED Board: L9002474  
230V ~ 50Hz





### (DE) Bestimmungsgemäße Verwendung

(EN) Intended use | (FR) Utilisation conforme | (NL) Beoogd gebruik | (PL) Stosowanie zgodnie z przeznaczeniem | (NO) Riktig bruk | (DK) Korrekt brug  
(SE) Avsedd användning | (FI) Määräystenmukainen käyttö | (IT) Impiego appropriato | (ES) Uso prescrito | (CZ) Použití v souladu s určením  
(PT) Utilização correta | (GR) Ενδεδειγμένη χρήση | (SK) Predpokladané použitie | (EE) Eeldatav kasutus | (LV) Paredzama lietojums  
(LT) Numatomas naudojimas | (RO) Utilizare intenționată | (SI) Predvidena uporaba | (HR) Namjenska upotreba | (HU) Tervezett felhasználás  
(BG) предназначена употреба | (AL) Përdorimi i parashikuar | (MK) Предвидена употреба | (TR) Amaçlı kullanım | (UK) Призначене використання  
(BA,ME,RS) Namjenska upotreba

(DE)	Ortsfeste Verwendung als Deckenleuchte im Innenbereich	(GB)	Provided for stationary indoor use on ceilings
(FR)	Installation fixe en tant que plafonnier à l'intérieur	(NL)	Vast gebruik als plafondlamp binnenshuis
(PL)	Do montażu stacjonarnego jako lampa sufitowa do wnętrz	(NO)	Til stasjonært bruk som taklampe innendørs
(DK)	Til stationær brug som loftlampe indendørs	(SE)	Används som fast taklampa inomhus
(FI)	Kiinteä käyttö sisätilojen kattovalaisimena	(IT)	Impiego fisso come plafoniera in ambienti interni
(ES)	Empleo fijo como lámpara de techo en interiores	(CZ)	Stacionární použití jako stropní svítidlo v interiéru
(PT)	Aplicação fixa como luminária de teto em interiores	(GR)	Σταθερή χρήση ως φωτιστικό οροφής σε εσωτερικό χώρο
(SK)	Pevné použitie ako stropné svietidlo v interiéri	(BG)	Постоянна употреба като таванно осветително тяло във вътрешни помещения
(EE)	Laepaigaldatava sisevalgusti statsionaarne kasutamise	(LV)	Pastāvīga izmantošana kā griestu gaismeklis iekšējā telpā
(LT)	Stacionarus naudojimas kaip lubų šviestuvus viduje	(RO)	Utilizare fixă ca plafonieră în interior
(SI)	Stalna uporaba kot stropna svetilka v notranjosti	(HR)	Stalna upotreba kao stropna svjetiljka u unutrašnjosti
(HU)	Állandó használat mint mennyezetre szerelhető belső világítótest	(AL)	I ofruar për përdorim të brendshëm të stacionar në tavan
(MK)	Обезбедено за стационарна употреба на тавани внатре	(TR)	Tavanlarda sabit iç mekan kullanımı için sağlanmıştır
(UK)	Забезпечено для стаціонарного внутрішнього використання на стелях	(BA)	Osigurano za stacionarnu unutarnju upotrebu na plafonima
		(ME)	
		(RS)	

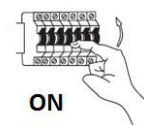
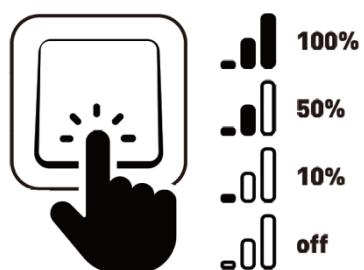
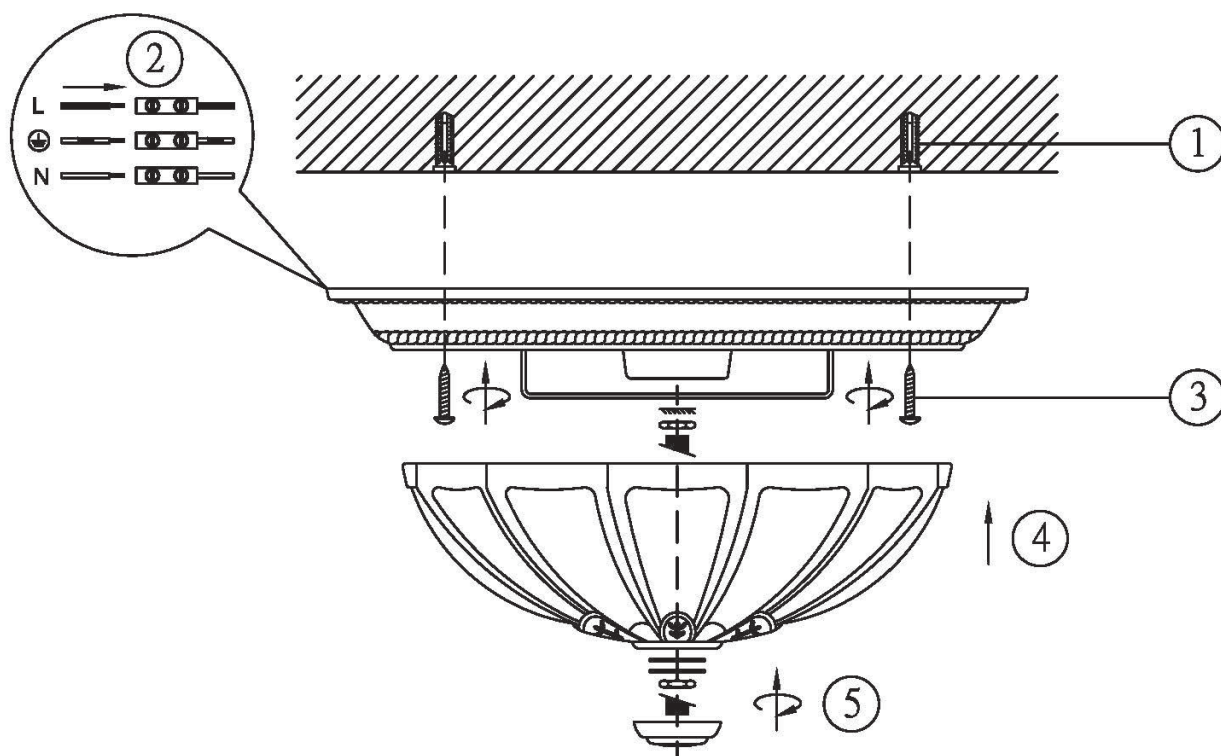
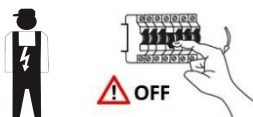
(DE) Lieferumfang		
(EN) Package contents   (FR) Contenu de la livraison   (NL) Bij de levering inbegrepen   (PL) Zakres dostawy   (NO) Levering   (DK) Leveringsomfang (SE) Leveransomfattning   (FI) Toimitussisältö   (IT) Fornitura   (ES) Volumen de suministro   (CZ) Rozsah dodávky   (PT) Material fornecido (GR) Παραδοτέος εξοπλισμός   (SK) Obsah balenia   (EE) Pakendi sisu   (LV) Pakas saturs   (LT) Pakuotės turinys (RO) Conținutul pachetului   (SI) Vsebina paketa   (HR) Sadržaj paketa   (HU) A csomag tartalma   (BG) обхват на доставката (AL) Përmbajtja e dorëzimit   (MK) Содржина на испорака   (TR) Teslimat içeriği   (UK) Зміст доставки   (BA,ME,RS) Sadržaj isporuke		
(DE) 1 Deckenleuchte Montagematerial Montageanleitung	(GB) 1 Ceiling lamp Installation hardware Mounting instructions	(FR) 1 Plafonnier Matériel de montage Instructions de montage
(NL) 1 Plafondlamp Monteringsmateriale Montagehandleiding	(PL) 1 Lampa sufitowa Elementy montażowe Instrukcja montażu	(NO) 1 Taklampe Monteringsmateriale Brukerveiledning
(DK) 1 Loftlampe Monteringsmateriale Brugervejledning	(SE) 1 Taklampa Monteringsmaterial Monteringsanvisning	(FI) 1 Kattovalaisin Asennus materiaali Asennusohjeet
(IT) 1 Plafoniera Materiale di montaggio Istruzioni di montaggio	(ES) 1 Lámpara de techo Material de montaje Instrucciones de montaje	(CZ) 1 Stropní svítidlo Materiál pro montáž Návod k montáži
(PT) 1 Luminária de teto Material de montagem Instruções de montagem	(GR) 1 Φωτιστικό οροφής Υλικό συναρμολόγησης Οδηγίες συναρμολόγησης	(SK) 1 stropné svietidlo Inštalračný hardvér Inštalračná príručka
(BG) 1 таванно осветително тяло материали за монтаж инструкции за монтаж	(EE) 1 laevalgusti Paigaldustarvikud Paigaldusjuhend	(LV) 1 griestu gaismeklis Instalācijas aparatūra Uzstādīšanas instrukcija
(LT) 1 lubų šviestuvai Montavimo aparatinė įranga Montavimo instrukcija	(RO) 1 plafonieră Hardware de instalare Instrucțiuni de montare	(SI) 1 stropna svetilka Namestitvena strojna oprema Navodila za montažo
(HR) 1 stropna svjetiljka Instalacijski hardver Upute za montažu	(HU) 1 mennyezeti világítótest Telepítési hardver Szerelési útmutató	(AL) 1 Lampa tavan Materiali i montimit Udhëzuesi i montimit
(MK) 1 Плафонска лампа Монтажен материјал Упатство за монтажа	(TR) 1 Tavan lambası Montaj malzemesi Montaj kılavuzu	(UK) 1 Світильник на стелі Монтажний матеріал Інструкція з монтажу
(BA) 1 Plafonska lamp (ME) Montažni materijal (RS) Uputstvo za montažu		



	(DE)	(EN)	(FR)	(NL)	(PL)	(NO)
<b>L</b>	Stromführender Leiter	Live conductor	Conducteur	Spanningvoerende draad	Przewód prądowy	Strømførende leder
	Schutzleiter	Earth conductor	Conducteur de protection (terre)	Aardkabel	Przewód uziemiający	Jordledningen
<b>N</b>	Neutralleiter	Neutral conductor	Conducteur neutre	Nulleider	Przewód zerowy	Nøytralleider

	(DK)	(SE)	(FI)	(IT)	(ES)	(CZ)
<b>L</b>	Strømførende leder	Strömförande ledare	Virtajohdin	Conduttore sotto tensione	Conductor de corriente	Vodič pod napětím
	Jordledningen	Skyddsledare	Suojajohdin	Conduttore di terra	Conductor de protección	Ochranný vodič
<b>N</b>	Neutralleider	Neutralledare	Nollajohdin	Conduttore neutro	Conductor neutro	Neutrální vodič



	(PT)	(GR)	(SK)	(EE)	(LV)	(LT)
<b>L</b>	Condutor vivo	Ρευματοφόρος αγωγός	Živý vodič	Faasisjuht	Dzīvais vadītājs	Gyvas dirigentas
	Condutor de terra	Αγωγός γείωσης	Zemný vodič	Maandusjuht	Zemes vadītājs	Žemės dirigentas
<b>N</b>	Condutor neutro	Ουδέτερος αγωγός	Neutrálný vodič	Neutraaljuht	Neitrālais vadītājs	Neutrinis dirigentas

	(RO)	(SI)	(HR)	(HU)	(BG)	(AL)
<b>L</b>	Conductor viu	Živi dirigent	Živi dirigent	Élő vezető	проводник под напряжение	Konduktor i gjallë
	Conductor de împământare	Zemeljski dirigent	Uzemljeni dirigent	Földvezető	защитен проводник	Dirigjent i tokës
<b>N</b>	Conductor neutru	Nevtralni dirigent	Neutralni dirigent	Semleges vezető	нулев проводник	Konduktor neutral

	(MK)	(TR)	(UK)	(BA)(ME)(RS)
<b>L</b>	Жив кондуктор	Canlı yönetici	Живий диригент	Živi dirigent
	Земјен проводник	Toprak iletkeni	Земельний провідник	Zemaljski provodnik
<b>N</b>	Неутрален проводник	Nötr iletken	Нейтральный провідник	Neutralni provodnik

## (DE) Verwendete Symbole

(EN) Safety Precautions | (FR) Symboles utilisés | (NL) Gebruikte symbolen | (PL) Stosowane symbole | (NO) Brukte symboler | (DK) Brugte symboler  
 (SE) Använda symboler | (FI) Käytetyt symbolit | (IT) Simboli usati | (ES) Símbolos empleados | (CZ) Použité symboly | (PT) Símbolos utilizados  
 (GR) Χρησιμοποιούμενα σύμβολα | (SK) Bezpečnostné opatrenia | (EE) Ohutusabinõud | (LV) Drošības pasākumi  
 (LT) Saugos priemonės | (RO) Măsuri de precauție | (SI) Varnostni ukrepi | (HR) Mjere opreza | (HU) Használt szimbólumok | (BG) Мерки за безопасност  
 (AL) Simbolet e përdorura | (MK) Користени симболи | (TR) Kullanılan semboller | (UK) Використовувані символи | (BA,ME,RS) Korišteni simboli

IP 20



<p>(DE) Dieses Produkt enthält eine Lichtquelle der Energieeffizienzklasse F          (EN) This product contains a light source of energy efficiency class F          (FR) Ce produit comprend une source de lumière de classe d'efficacité énergétique F          (NL) Dit product bevat een lichtbron van energie-efficiëntieklasse F          (PL) Produkt ten zawiera źródło światła o klasie efektywności energetycznej F          (NO) Dette produktet inneholder en lyskilde i energieeffektivitetsklasse F          (DK) Dette produkt indeholder en lyskilde af energieeffektklasse F          (SE) Denna produkt innehåller en ljuskälla i energieeffektivitetsklass F          (FI) Tämä tuote sisältää energiatehokkuusluokan F valonlähteen          (IT) Questo prodotto contiene una sorgente luminosa della classe di efficienza energetica F          (ES) Este producto contiene una fuente de luz de la clase de eficiencia energética F          (CZ) Tento výrobek obsahuje světelný zdroj třídy energetické účinnosti F          (PT) Este produto contém uma fonte de luz da classe de eficiência energética F          (GR) Αυτό το προϊόν περιέχει μια φωτεινή πηγή ενεργειακής απόδοσης κλάσης F          (SK) Tento výrobok obsahuje zdroj svetla triedy energetickej efektivity F          (EE) See toode sisaldab energiatõhususklassi F valgusallikat          (LV) Šis produkts satur enerģijas efektivitātes klases F gaismas avotu          (LT) Šis gaminys turi energijos efektyvumo klasės F šviesos šaltinį          (RO) Acest produs conține o sursă de lumină de clasă de eficiență energetică F          (SI) Ta izdelek vsebuje svetlobni vir energijskega razreda F          (HR) Ovaj proizvod sadrži izvor svjetlosti energetske učinkovitosti klase F          (HU) Ez a termék egy F energiahatékonysági osztályú fényforrást tartalmaz          (BG) Този продукт съдържа източник на светлина с клас на енергийна ефективност: F          (AL) Ky produkt përmban një burim drite të klasës së efikasitetit të energjisë F          (MK) Овој производ содржи извор на светлина од класа на енергетска ефикасност F          (TR) Bu ürün, enerji verimliliği sınıfı F olan bir ışık kaynağı içerir          (UK) Цей продукт містить джерело світла класу енергоефективності F          (BA)(ME)(RS) Ovaj proizvod sadrži izvor svjetlosti energetske klase F</p>	<p>QR</p> 	<p>EAN</p> <p>4251911755787</p>
---	---	---------------------------------

	<p>(DE) Die Lichtquelle dieser Leuchte ist nicht ersetzbar.          (EN) The light source is not replaceable.          (FR) La source lumineuse de cette lampe n'est pas remplaçable.          (NL) De lichtbron van deze lamp is niet vervangbaar.          (PL) Źródło światła w tej lampie jest niewymienne.          (NO) Lyskilden i denne lampen er ikke mulig å bytte ut.          (DK) Lyskilden til denne lampe kan ikke udskiftes.          (SE) Ljuskällan i denna lampa är inbyggd och är inte utbytbar.          (FI) Tämän valaisimen valonlähde ei voi vaihtaa.          (IT) La sorgente luminosa di questa lampada non è sostituibile.          (ES) La fuente de luz de esta lámpara no es reemplazable.          (CZ) Světelný zdroj nelze vyměnit.          (PT) A fonte de luz deste candeeiro não permite a substituição.          (GR) Η πηγή φωτισμού αυτού του φωτιστικού δεν μπορεί να αντικατασταθεί.          (SK) Svetelný zdroj tohto svietidla nie je vymeniteľný.          (EE) Valgusallikat ei saa asendada.          (LV) Gaismas avots nav aizstājams.          (LT) Šviesos šaltinis nekeičiamas.          (RO) Sursa de lumină nu poate fi înlocuită.          (SI) Vir svetlobe ni zamenljiv.          (HR) Izvor svjetla nije zamjenjiv.          (HU) A fényforrás nem cserélhető ki.          (BG) Източникът на светлина не може да се замени.          (AL) Burimi i dritës nuk mund të zëvendësohet.          (MK) Изворот на светлина не е заменлив.          (TR) Işık kaynağı değiştirilemez.          (UK) Джерело світла не можна замінити.          (BA)(ME)(RS) Izvor svjetlosti nije zamjenjiv.</p>
---	---

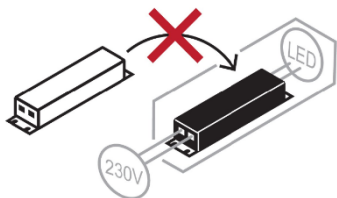

**(DE)** Das Betriebsgerät dieser Leuchte ist nicht ersetzbar.

**(EN)** The control gear is not replaceable.

**(FR)** Le ballast de ce luminaire n'est pas remplaçable.

**(NL)** Het voorschakelapparaat is bij dit artikel niet vervangbaar.

**(PL)** Statecznik w lampie jest niewymienny

**(NO)** Kontrollutstyret til denne armaturen kan ikke skiftes ut.

**(DK)** Denne lampes ballast kan ikke udskiftes.

**(SE)** Armaturens styranordning är inte utbytbar.

**(FI)** Tämän valaisimen ohjauslaitetta ei voi vaihtaa.

**(IT)** Il dispositivo di alimentazione di questa lampada non è sostituibile.

**(ES)** El balastro de esta lámpara no es reemplazable.

**(CZ)** Ovládací zařízení tohoto svítidla není vyměnitelné.

**(PT)** O equipamento de controlo desta luminária não é substituível.

**(GR)** Ο μηχανισμός ελέγχου αυτού του φωτιστικού δεν μπορεί να αντικατασταθεί.

**(SK)** Ovládacie zariadenie tohto svietidla nie je vymeniteľné.

**(EE)** Juhtseadet ei saa asendada.

**(LV)** Vadības ierīce nav aizstājama.

**(LT)** Valdymo įrenginys nekeičiamas.

**(RO)** Echipamentul de control nu poate fi înlocuit.

**(SI)** Krmilna oprema ni zamenljiva.

**(HR)** Upravljačka oprema nije zamjenjiva.

**(HU)** A vezérlőberendezés nem cserélhető.

**(BG)** Управляващото оборудване не може да се замени.

**(AL)** Pajisja e kontrollit nuk është e zëvendësueshme.

**(MK)** Контролната опрема не може да се замени.

**(TR)** Kontrol donanımı değiştirilemez.

**(UK)** Керуючий пристрій не підлягає заміні.

**(BA)(ME)(RS)** Upravljačka oprema nije zamjenjiva.