

p

Pujol
iluminación

Pujol Iluminación S.L.
Indústria 13, 08980 Sant Feliu de Llobregat - Barcelona (Spain)
Tel. 34 93 685 7880 - Fax 34 93 685 1765
export@pujoliluminacion.com - comercial@pujoliluminacion.com
www.pujoliluminacion.com



PS-175/100

LED Tischleuchte

Familie: CUB

Anwendungstyp: Tischleuchten

Diffusor: Glas

Gehäuse: Aluminium

Farben:



B - Weiß



C - Chrome



CoS - Satin Kupfer



N - Schwarz



Nm - Matt Nickel

Lampentyp: G-9 LED

Dimmbar: NEIN

Schalter: JA

p

Pujol
iluminación

Pujol Iluminación S.L.
Indústria 13, 08980 Sant Feliu de Llobregat - Barcelona (Spain)
Tel. 34 93 685 7880 - Fax 34 93 685 1765
export@pujoliluminacion.com - comercial@pujoliluminacion.com
www.pujoliluminacion.com

Spezifikationen

IP20

RF 850º



Installation auf brennbaren Oberflächen



Klasse II

Abmessungen:

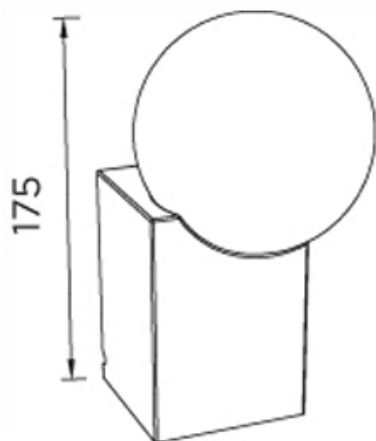

Effizienz label:

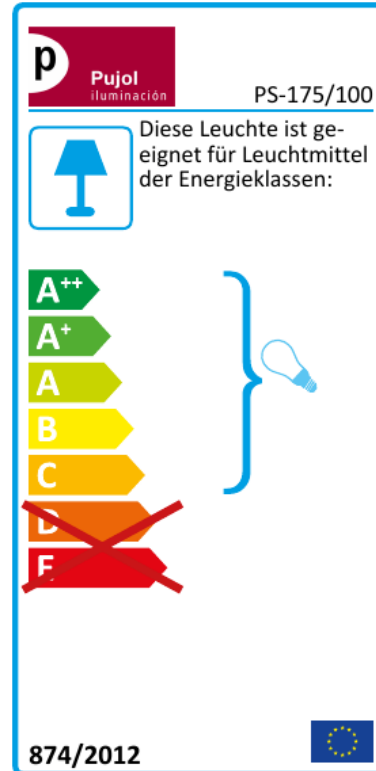

p

Pujol
iluminación

Pujol Iluminación S.L.
Indústria 13, 08980 Sant Feliu de Llobregat - Barcelona (Spain)
Tel. 34 93 685 7880 - Fax 34 93 685 1765
export@pujoliluminacion.com - comercial@pujoliluminacion.com
www.pujoliluminacion.com

Mehr Bilder:



p

Pujol
iluminación

Pujol Iluminación S.L.
Indústria 13, 08980 Sant Feliu de Llobregat - Barcelona (Spain)
Tel. 34 93 685 7880 - Fax 34 93 685 1765
export@pujoliluminacion.com - comercial@pujoliluminacion.com
www.pujoliluminacion.com

