

# HOPE

design Francisco Gomez Paz / Paolo Rizzato

Type: Suspension



|               |                 |   |                                   |
|---------------|-----------------|---|-----------------------------------|
| Light source: | D66/12 - D66/18 | 105W HSGSA E27<br>23W FB E27<br>LED E27             | EEL: D<br>EEL: A<br>EEL: A++/A+/A |
|               | D66/42          | 3 x 105W HSGSA E27<br>3 x 23W FB E27<br>3 x LED E27 | EEL: D<br>EEL: A<br>EEL: A++/A+/A |
|               | D66/105         | 5 x 105W HSGSA E27<br>5 x 23W FB E27<br>5 x LED E27 | EEL: D<br>EEL: A<br>EEL: A++/A+/A |

Product use: Indoor

Materials: Structure in polished stainless steel and polycarbonate arms, polycarbonate prismatic lenses

Colors: Transparent

Description: Incredibly light and easy to dismantle, Hope presents the magic of traditional chandeliers, reinterpreting them with sophisticated modern technologies and contemporary materials. A series of thin polycarbonate Fresnel lenses multiply the light from the light source, recreating a pleasant, glittery and party-like atmosphere, sprinkled with thousands of tiny reflections.

Insulation class:  (D66/42 - D66/105)  D66/12 - D66/18)



Awards: Red Dot Design Award 2010, prize  
Good Design Chicago Athenaeum, 2010  
Premio dei Premi 2011, prize  
Compasso d'Oro ADI 2011, prize

|                 |         |              |
|-----------------|---------|--------------|
| Reference code: | D66/12  | 1D6612S00000 |
|                 | D66/18  | 1D6618S00000 |
|                 | D66/42  | 1D6642S00000 |
|                 | D66/105 | 1D66105S0000 |

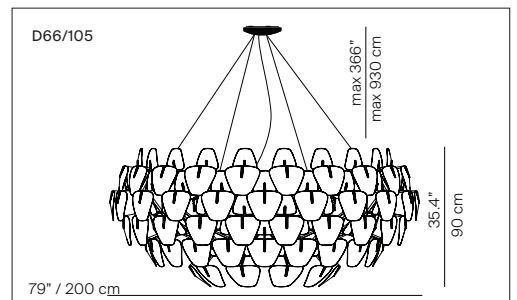
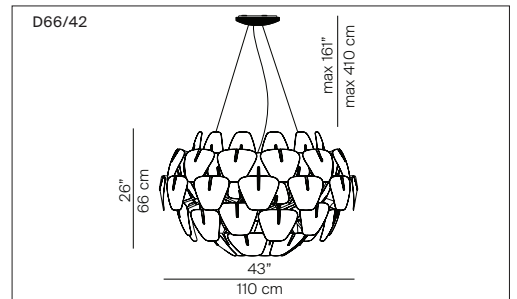
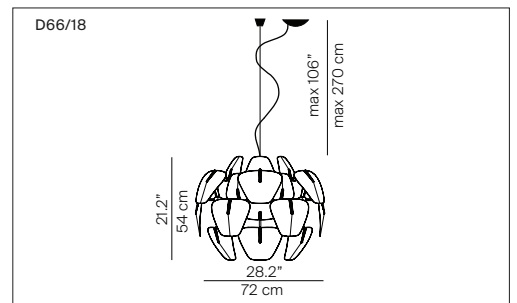
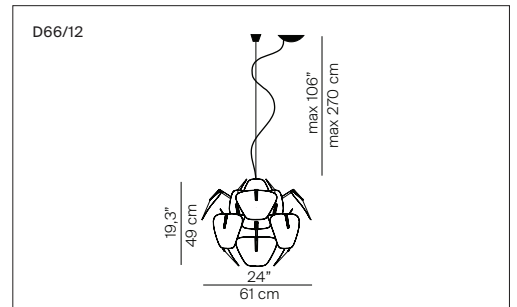

# HOPE

design Francisco Gomez Paz / Paolo Rizzato

## Composition Kit

**A**

**D66/105**

**D66/42**

**D66/42**

h tot min 400 cm

weight 23 kg

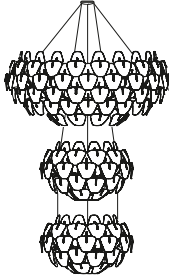

**B**

**D66/105**

**D66/18**

**D66/18**

h tot min 363 cm

weight 23 kg

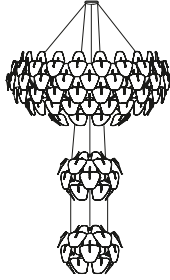

**C**

**D66/105**

**D66/18**

h tot min 364 cm

weight 27,5 kg

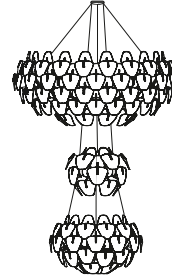

**D**

**D66/105**

**D66/42**

**D66/18**

h tot min

374 cm

weight 27,5 kg

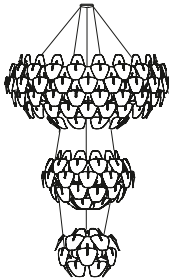

**E**

**D66/42**

**D66/105**

h tot min

325 cm

weight 32 kg

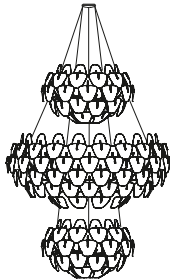

**F**

**D66/42**

**D66/105**

**D66/18**

h tot min

299 cm

weight 27,5 kg

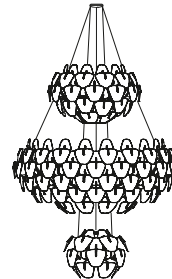

**G**

**D66/18**

**D66/105**

h tot min 324 cm

weight 27,5 kg

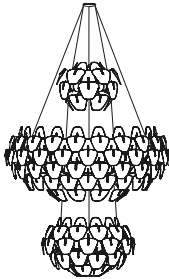

**H**

**D66/18**

**D66/42**

h tot min 249 cm

weight 27,5 kg

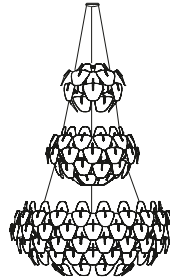

**I**

**D66/42**

**D66/42**

h tot min 245 cm

weight 21 kg

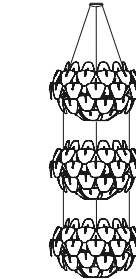

**D66/18**

**D66/18**

**D66/105**

h tot min 303 cm

weight 23 kg

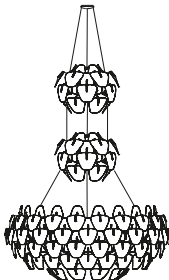

**D66/42**

**D66/42**

h tot min 229 cm

weight 16,5 kg

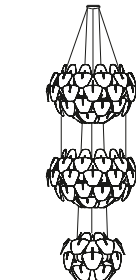

**D66/42**

**D66/18**

**D66/42**

h tot min 219 cm

weight 16,5 kg

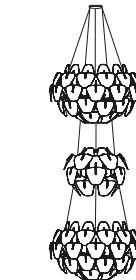

**P**

**D66/18**

**D66/42**

**D66/18**

h tot min 198 cm

weight 12 kg

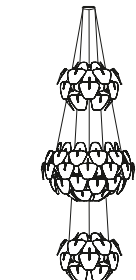

**Q**

**D66/18**

**D66/18**

**D66/42**

h tot min 198 cm

weight 12 kg

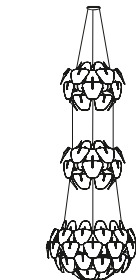

**R**

**D66/42**

**D66/18**

**D66/18**

h tot min 213 cm

weight 12 kg

