

9968022

40W LED ↑ + 20W LED ↓ / 60W Total
incl. LED Board: L9001458 + L9001459
230V ~ 50Hz

**(DE) Bestimmungsgemäße Verwendung**

(GB) Intended use / (FR) Utilisation conforme / (NL) Beoogd gebruik / (PL) Stosowanie zgodnie z przeznaczeniem /
(NO) Riktig bruk / (DK) Korrekt brug / (SE) Avsedd användning / (FI) Määräystenmukainen käyttö

(IT) Impiego appropriato / (ES) Uso prescrito / (CZ) Použití v souladu s určením / (PT) Utilização correta / (GR) Ενδεδειγμένη χρήση

| | | | |
|------|---|------|---|
| (DE) | Als Stehleuchte im Innenbereich | (GB) | Use as a floor lamp indoors |
| (FR) | En tant que lampadaire sur des sols plats, stables, à l'intérieur | (NL) | Binnenshuis als staande lamp op effen ondergrond |
| (PL) | Jako lampa stojąca na równych, stabilnych podłogach we wnętrzach | (NO) | Som gulvlampe på rett flate innendørs |
| (DK) | Som gulvlampe på ret gulv indendørs | (SE) | Används som golvlampa inomhus |
| (FI) | Käyttö sisätilojen lattiavalaisimena | (IT) | Impiego come lampada da pavimento in ambienti interni |
| (ES) | Empleo en tanto lámpara de pie en interiores | (CZ) | Použití jako stojací lampa v interiéru |
| (PT) | Aplicação como candeeiro de pé em interiores | (GR) | Χρήση ως επιδαπέδιο φωτιστικό σε εσωτερικό χώρο |

(DE) Verwendete Symbole

(GB) Safety Precautions / (FR) Symboles utilisés / (NL) Gebruikte symbolen / (PL) Stosowane symbole / (NO) Brukte symboler /
(DK) Brugte symboler / (SE) Använda symboler / (FI) Käytetyt symbolit / (IT) Simboli usati / (ES) Símbolos empleados /
(CZ) Použité symboly / (PT) Símbolos utilizados / (GR) Χρησιμοποιούμενα σύμβολα

IP 20

**(DE) Lieferumfang**

(GB) Package contents / (FR) Contenu de la livraison / (NL) Bij de levering inbegrepen / (PL) Zakres dostawy / (NO) Levering /
(DK) Leveringsomfang / (SE) Leveransomfattning / (FI) Toimitussisältö / (IT) Fornitura / (ES) Volumen de suministro /
(CZ) Rozsah dodávky / (PT) Material fornecido / (GR) Παραδοτέος εξοπλισμός

| | | | | | |
|------|---|------|--|------|--|
| (DE) | 1 Stehleuchte Montagematerial Montageanleitung | (GB) | 1 Floor lamp Installation hardware Mounting instructions | (FR) | 1 Lampadaire Matériel de montage Instructions de montage |
| (NL) | 1 Vloerlamp Monteringsmateriale Montagehandleiding | (PL) | 1 Lampa stojąca Elementy montażowe Instrukcja montażu | (NO) | 1 Gulvlampe Monteringsmateriale Brukerveiledning |
| (DK) | 1 Gulvlampe Monteringsmateriale Brugervejledning | (SE) | 1 Golvlampa Monteringsmaterial Monteringsanvisning | (FI) | 1 Lattiavalaisin Asennus materiaali Asennusohjeet |
| (IT) | 1 Lampada da pavimento Materiale di montaggio Istruzioni di montaggio | (ES) | 1 Lámpara de pie Material de montaje Instrucciones de montaje | (CZ) | 1 Stojací lampa Materiál pro montáž Návod k montáži |
| (PT) | 1 Candeeiro de pé Material de montagem Instruções de montagem | (GR) | 1 Επιδαπέδιο φωτιστικό Υλικό συναρμολόγησης Οδηγίες συναρμολόγησης | | |

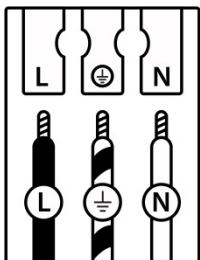
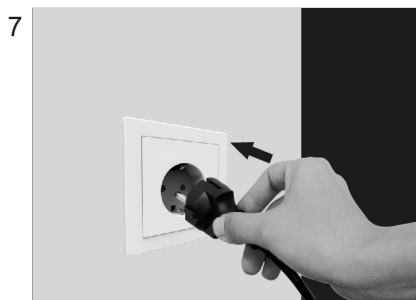
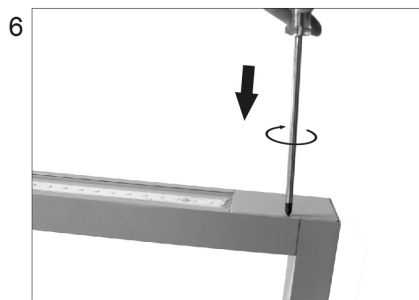
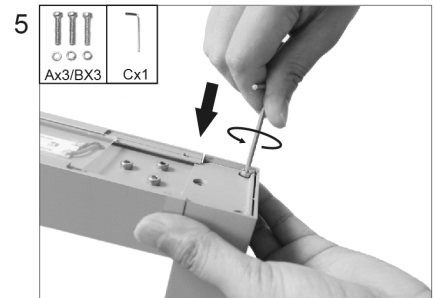
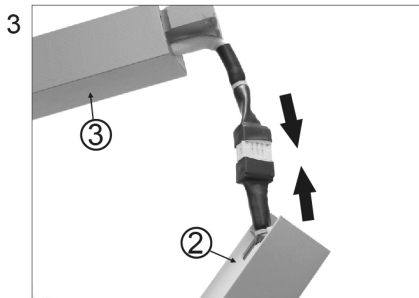
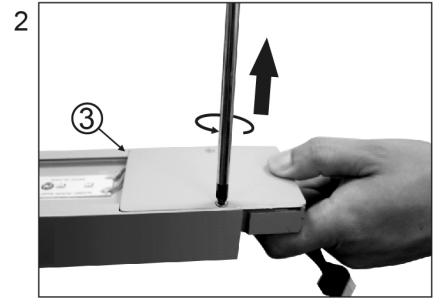
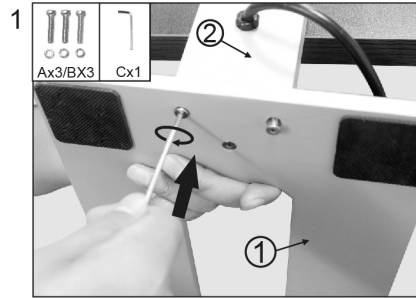
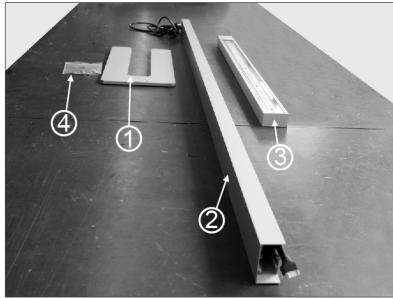
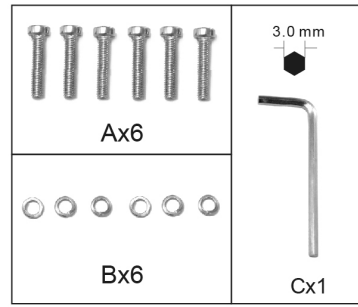

| | (DE) | (GB) | (FR) | (NL) | (PL) | (NO) | (DK) |
|----------|-----------------------|-------------------|----------------------------------|------------------------|---------------------|--------------------|--------------------|
| L | Stromführender Leiter | Live conductor | Conducteur | Spanningvoerende draad | Przewód prądowy | Strømførende leder | Strømførende leder |
| | Schutzleiter | Earth conductor | Conducteur de protection (terre) | Aardkabel | Przewód uziemiający | Jordledningen | Jordledningen |
| N | Neutralleiter | Neutral conductor | Conducteur neutre | Nulleider | Przewód zerowy | Nøytralleider | Neutralleider |

| | (SE) | (FI) | (IT) | (ES) | (CZ) | (PT) | (GR) |
|----------|---------------------|-------------|---------------------------|---------------------------------|-------------------|-------------------|---------------------|
| L | Strömförande ledare | Virtajohdin | Conduttore sotto tensione | Líneas conductoras de corriente | Vodič pod napětím | Condutor vivo | Ρευματοφόρος αγωγός |
| | Skyddsledare | Suojajohdin | Conduttore di terra | Conductor de protección | Ochranný vodič | Condutor de terra | Αγωγός γείωσης |
| N | Neutralledare | Nollajohdin | Conduttore neutro | Conductor neutro | Neutrální vodič | Condutor neutro | Ουδέτερος αγωγός |



Kurz drücken: indirektes Licht an/ aus - gedrückt halten: Dimmen
 Short press to turn on/ off the indirect light - long press to dimming
 Appuyez brièvement: éclairage indirect allumé / éteint - maintenez la touche enfoncée : faire baisser l'intensité lumineuse

AN-AUS Schalter:

1. AN: Beim Einschalten wird die vorherige Lichteinstellung beibehalten
2. AUS: Leuchte wird ausgeschaltet

ON-OFF Switch:

1. ON: Turn on and will keep light same as previous status automatically
2. OFF: Turn off the light

Interrupteur ON-OFF:

1. ON : effet de mémoire lors de la mise en marche
2. OFF : ce bouton éteint la lumière

Kurz drücken: direktes Licht an/ aus - gedrückt halten: Dimmen
 Short press to turn on/ off the direct light - long press to dimming
 Appuyez brièvement : éclairage direct allumé / éteint - maintenez la touche enfoncée : faire baisser l'intensité lumineuse

Bewegungssensor/ motion sensor/ capteur de mouvement

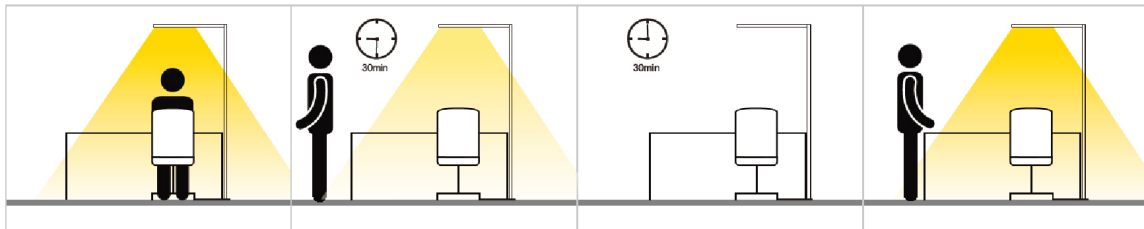

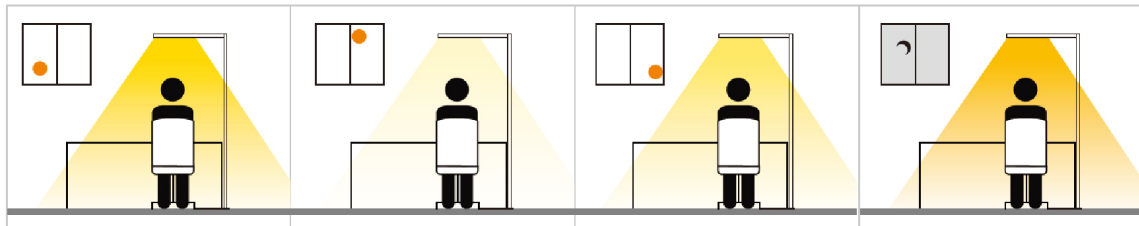

1. Leuchte einschalten/ turn on the lamp / allumer le luminaire.
2. Keine Bewegung innerhalb von 30 Min: Helligkeit reduziert sich auf 30% / The lamp brightness reduces to 30% when there is no presence in 30min / aucun mouvement dans les 30 minutes : la luminosité est réduite à 30%.
3. Nach weiteren 30 Min ohne Bewegung schaltet sich die Leuchte automatisch aus / after another 30 min, the lamp switches off automatically when still no presence detected / après 30 minutes sans mouvement, le luminaire s'éteint automatiquement.
4. Leuchte schaltet sich wieder ein, sobald eine Bewegung erfasst wird / the lamp will switches on automatically at once when there is presence detected / la lumière s'allume à nouveau dès qu'un mouvement est détecté.

Tageslichtsensor/ daylight sensor/ capteur de lumière du jour

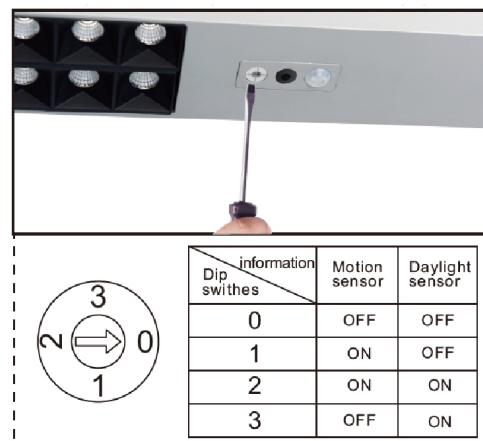
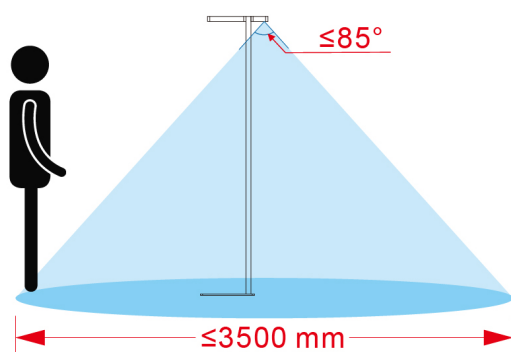

Das Licht kann in Abhängigkeit von der Umgebungshelligkeit automatisch hoch- oder runtergedimmt werden / the control unit can dims light output down or up automatically according to the changes of environment brightness / la lumière peut être automatiquement enfoncée ou diminuée en fonction de la luminosité ambiante.



| | | |
|---|---|---------------|
| <p>(DE) Dieses Produkt enthält eine Lichtquelle der Energieeffizienzklasse D (EN) This product contains a light source of energy efficiency class D (FR) Ce produit comprend une source de lumière de classe d'efficacité énergétique D (NL) Dit product bevat een lichtbron van energie-efficiëntieklasse D (PL) Produkt ten zawiera źródło światła o klasie efektywności energetycznej D (NO) Dette produktet inneholder en lyskilde i energieeffektivitetsklasse D (DK) Dette produkt indeholder en lyskilde af energieeffektklasse D (SE) Denna produkt innehåller en ljuskälla i energieffektivitetsklass D (FI) Tämä tuote sisältää energiätehokkuusluokan D valonlähteen (IT) Questo prodotto contiene una sorgente luminosa della classe di efficienza energetica D (ES) Este producto contiene una fuente de luz de la clase de eficiencia energética D (CZ) Tento výrobek obsahuje světelný zdroj třídy energetické účinnosti D (PT) Este produto contém uma fonte de luz da classe de eficiência energética D (GR) Αυτό το προϊόν περιέχει μια φωτεινή πηγή ενεργειακής απόδοσης κλάσης D (SK) Tento výrobok obsahuje zdroj svetla triedy energetickej efektivity D</p> | QR | EAN |
| |  | 4251911718430 |

| | | |
|---|--|---------------|
| <p>(DE) Dieses Produkt enthält eine Lichtquelle der Energieeffizienzklasse D (EN) This product contains a light source of energy efficiency class D (FR) Ce produit comprend une source de lumière de classe d'efficacité énergétique D (NL) Dit product bevat een lichtbron van energie-efficiëntieklasse D (PL) Produkt ten zawiera źródło światła o klasie efektywności energetycznej D (NO) Dette produktet inneholder en lyskilde i energieeffektivitetsklasse D (DK) Dette produkt indeholder en lyskilde af energieeffektklasse D (SE) Denna produkt innehåller en ljuskälla i energieffektivitetsklass D (FI) Tämä tuote sisältää energiätehokkuusluokan D valonlähteen (IT) Questo prodotto contiene una sorgente luminosa della classe di efficienza energetica D (ES) Este producto contiene una fuente de luz de la clase de eficiencia energética D (CZ) Tento výrobek obsahuje světelný zdroj třídy energetické účinnosti D (PT) Este produto contém uma fonte de luz da classe de eficiência energética D (GR) Αυτό το προϊόν περιέχει μια φωτεινή πηγή ενεργειακής απόδοσης κλάσης D (SK) Tento výrobok obsahuje zdroj svetla triedy energetickej efektivity D</p> | QR | EAN |
| |  | 4251911718447 |

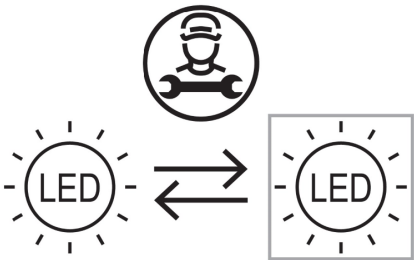
| | |
|---|--|
|  | <p>(DE) Durch einen Fachmann austauschbare Lichtquelle (nur LED) (EN) Replaceable (LED only) light source by a professional. (FR) Source de lumière remplaçable (LED uniquement) par un professionnel. (NL) Lichtbron (alleen led) te vervangen door een professional. (PL) Wymienne (tylko LED) źródło światła wykonane przez profesjonalistę. (NO) Utskiftbar (kun LED) lyskilde av en profesjonell. (DK) Udskiftelig lyskilde (kun LED), udskiftes af en elektriker. (SE) Ljuskälla (endast LED) utbytbar genom fackman. (FI) Ammattilainen voi vaihtaa vaihdettavan (vain LED) valonlähteen. (IT) Sorgente luminosa (solo LED) sostituibile da un professionista. (ES) Fuente de luz (solo LED) sustituible por un profesional. (CZ) Vyměnitelný (pouze LED) světelný zdroj odborníkem. (PT) Luz LED (apenas LED) substituível por um profissional. (GR) Η πηγή φωτός (μόνο LED) να αντικαθίσταται από επαγγελματία. (SK) Zdroj svetla (iba LED) vymeniteľný prostredníctvom odborníka.</p> |
|---|--|

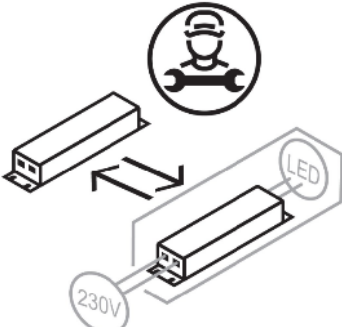
| | |
|---|---|
|  | <p>(DE) Durch einen Fachmann austauschbares Betriebsgerät. (EN) Replaceable control gear by a professional. (FR) Contrôleur remplaçable par un professionnel. (NL) Voorschakelapparatuur te vervangen door een professional. (PL) Wymienny układ sterujący przez profesjonalistę. (NO) Utskiftbar kontrollutstyr av en profesjonell. (DK) Udskiftelig igangsætter, udskiftes af en elektriker. (SE) Styrdon utbytbar genom fackman. (FI) Ammattilainen voi vaihtaa vaihdettavat ohjauslaitteet. (IT) Dispositivo di controllo sostituibile da un professionista. (ES) Dispositivo de control sustituible por un profesional. (CZ) Vyměnitelný předřadník odborníkem. (PT) Dispositivo de controlo substituível por um profissional. (GR) Ο εξοπλισμός ελέγχου να αντικαθίσταται από επαγγελματία. (SK) Predradník vymeniteľný prostredníctvom odborníka.</p> |
|---|---|