

## Safety Instructions

1, 2, 3, 4, 5, 6, 7, 10, 12, 13, 14, 15, 16,  
17, 18, 19, 20, 21, 22, 24, 28, 33, 34



Info

[www.paulmann.com](http://www.paulmann.com)

Paulmann Licht GmbH  
Quezinger Feld 2  
31832 Springe  
Germany

[www.paulmann.com](http://www.paulmann.com)

Art.-Nr.: 929.70  
929.71  
929.72  
929.73  
929.74  
929.75  
929.76



929.70\_929.72\_929.74

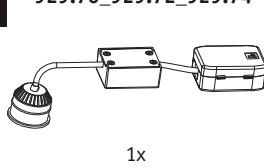

1x

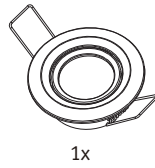

1x



2x

929.76

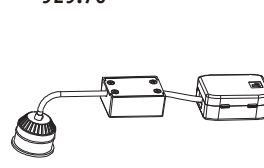

1x



2x

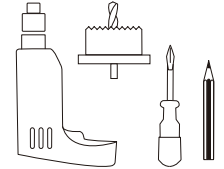

(+MA326) PSPU 01/20



929.71\_929.73\_929.75

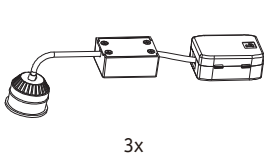

3x

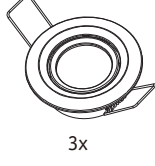

3x

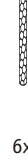

6x

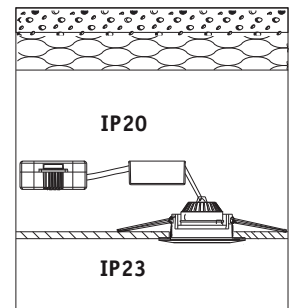
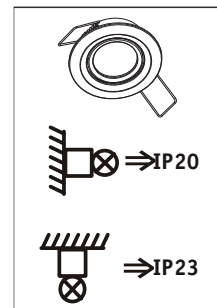
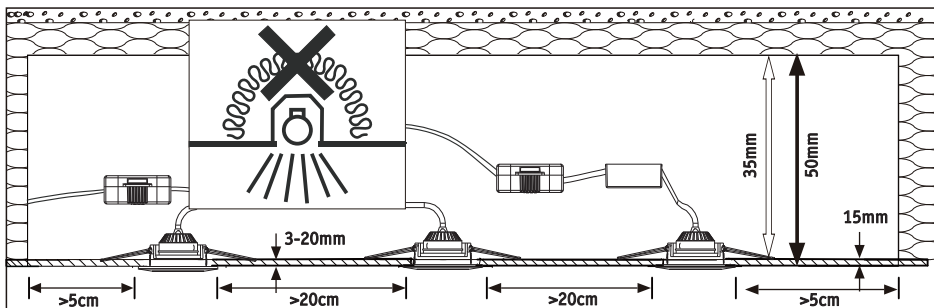

**A**

**Safety Instructions**  
Nr. 1, 4, 5, 7

off

item number	hole size
929.70_929.71	ø54mm
929.72_929.73	ø54mm
929.74_929.75	ø55mm

ø x mm

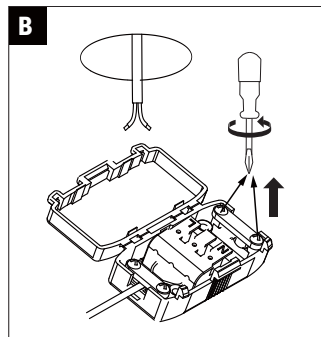





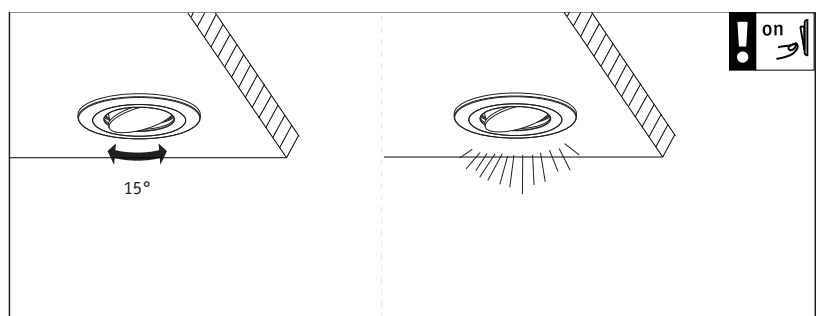
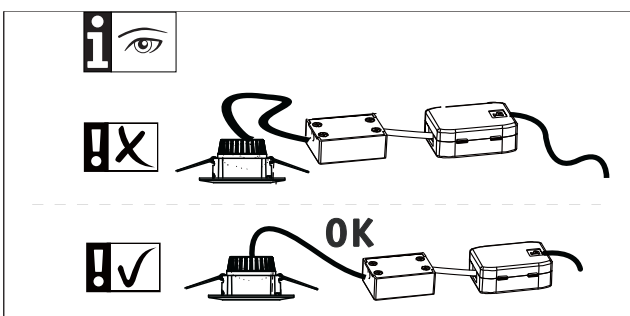
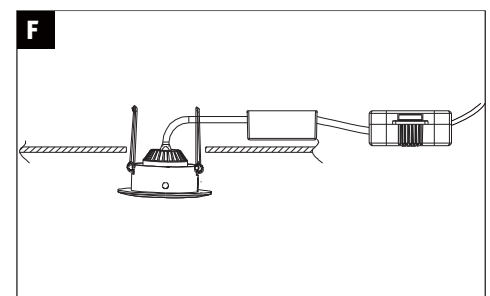
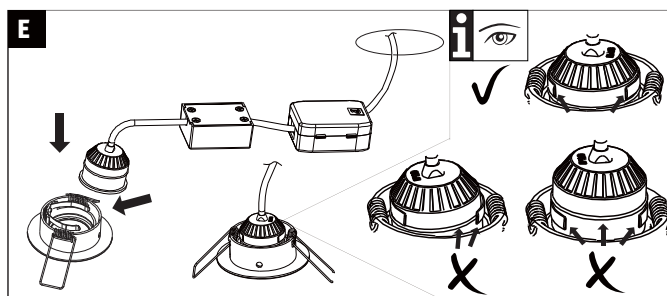
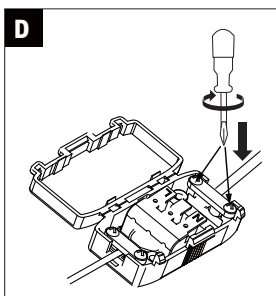

**C**

a.

b.

Nr. 3, 4, 5, 6

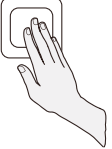

 Preset preset brightness (original preset brightness = max. brightness)	 Max. max. brightness	 brightness to dark	 on 
 Temp. temporary brightness	 Min. min. brightness	 brightness to bright	

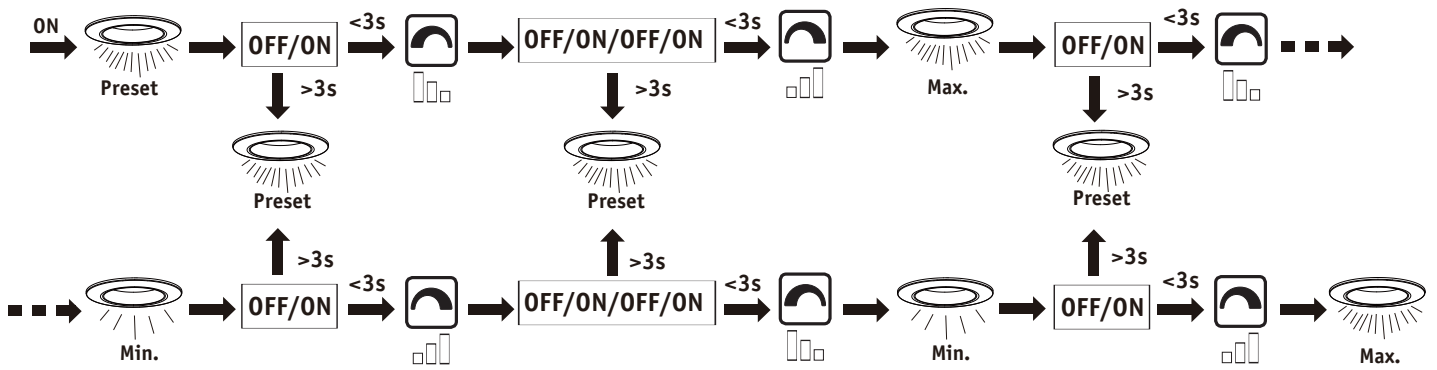
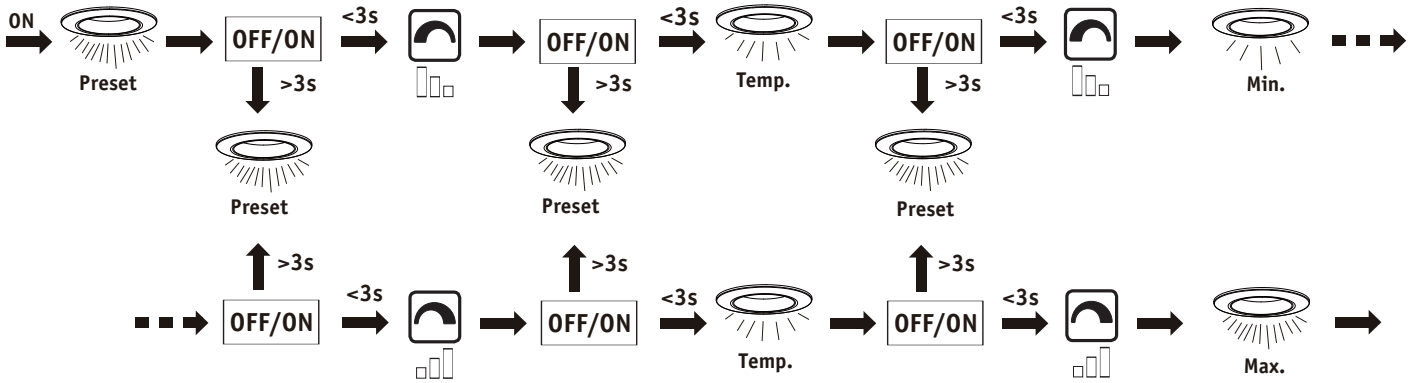

• Preset-function •

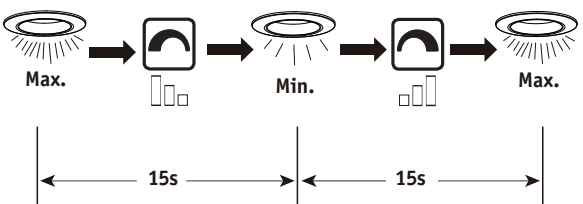
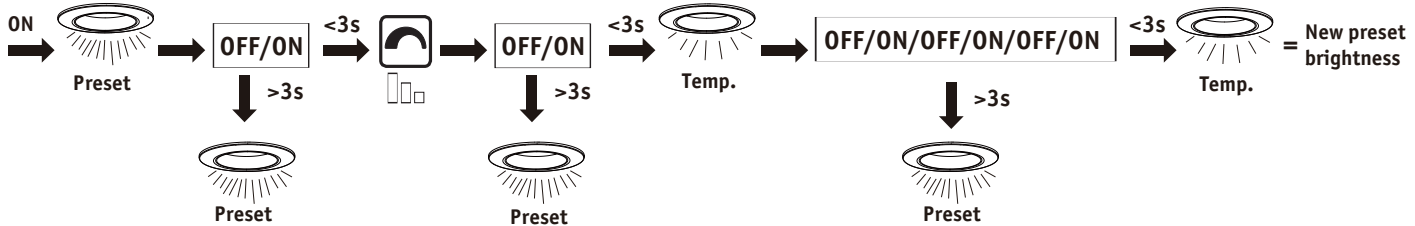

**ENERG** Y IJA IE IA  
енергия · ενεργεια

**A+**

A++  
A+  
A  
B  
C  
D  
E

5 kWh/1000h

**300 lm**  
4.2 W  
230 V

warm white  
2700K

CRI/Ra ≥ 80

ON OFF ≥50.000

≈30x 1.000h

Lumen 60% <1 s

ø35 mm

CE

390092976