

9968051

↑27W LED + ↓27W LED / 60W Total
230V ~ 50Hz

**(DE) Bestimmungsgemäße Verwendung**

(GB) Intended use / (FR) Utilisation conforme / (NL) Beoogd gebruik / (PL) Stosowanie zgodnie z przeznaczeniem /
(NO) Riktig bruk / (DK) Korrekt brug / (SE) Avsedd användning / (FI) Määräystenmukainen käyttö

(IT) Impiego appropriato / (ES) Uso prescrito / (CZ) Použití v souladu s určením / (PT) Utilização correta / (GR) Ενδεδειγμένη χρήση

(DE)	Ortsfeste Verwendung als Hängeleuchte im Innenbereich	(GB)	Provided for stationary indoor use as pendant light
(FR)	Utilisation stationnaire en tant que suspension d'intérieur	(NL)	Vast gebruik als hanglamp binnenshuis
(PL)	Do montażu stacjonarnego jako lampa wisząca do wnętrza	(NO)	Til stasjonært bruk som pendellampe innendørs
(DK)	Til stationær brug som pendellampe indendørs	(SE)	Används som fast hänglampa inomhus
(FI)	Kiinteä käyttö sisätilojen riippuväläisimena	(IT)	Impiego fisso come lampada a sospensione in ambienti interni
(ES)	Empleo fijo en tanto lámpara colgante en interiores	(CZ)	Stacionární použití jako závěsné svítidlo v interiéru
(PT)	Aplicação fixa como candeeiro suspenso em interiores	(GR)	Σταθερή χρήση ως κρεμαστό φωτιστικό σε εσωτερικό χώρο

(DE) Verwendete Symbole

(GB) Safety Precautions / (FR) Symboles utilisés / (NL) Gebruikte symbolen / (PL) Stosowane symbole / (NO) Brukte symboler /
(DK) Brugte symboler / (SE) Använda symboler / (FI) Käytetyt symbolit / (IT) Simboli usati / (ES) Símbolos empleados /
(CZ) Použité symboly / (PT) Símbolos utilizados / (GR) Χρησιμοποιούμενα σύμβολα

IP 20

**(DE) Lieferumfang**

(GB) Package contents / (FR) Contenu de la livraison / (NL) Bij de levering inbegrepen / (PL) Zakres dostawy / (NO) Levering /
(DK) Leveringsomfang / (SE) Leveransomfattning / (FI) Toimitussisältö / (IT) Fornitura / (ES) Volumen de suministro /
(CZ) Rozsah dodávky / (PT) Material fornecido / (GR) Παραδοτέος εξοπλισμός

(DE)	1 Hängeleuchte Montagematerial Montageanleitung	(GB)	1 Pendant light Installation hardware Mounting instructions	(FR)	1 Suspension Matériel de montage Instructions de montage
(NL)	1 Hanglamp Monteringsmateriale Montagehandleiding	(PL)	1 Lampa wisząca Elementy montażowe Instrukcja montażu	(NO)	1 Pendellampe Monteringsmateriale Brukerveiledning
(DK)	1 Pendellampe Monteringsmateriale Brugervejledning	(SE)	1 Hänglampa Monteringsmaterial Monteringsanvisning	(FI)	1 Riippuväläisin Asennusmateriaali Asennusohjeet
(IT)	1 Lampada a sospensione Materiale di montaggio Istruzioni di montaggio	(ES)	1 Lámpara colgante Material de montaje Instrucciones de montaje	(CZ)	1 Závěsné svítidlo Materiál pro montáž Návod k montáži
(PT)	1 Candeeiro suspenso Material de montagem Instruções de montagem	(GR)	1 Κρεμαστό φωτιστικό Υλικό συναρμολόγησης Οδηγίες συναρμολόγησης		

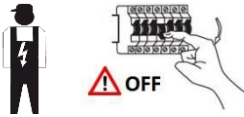

ARCCHIO

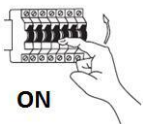
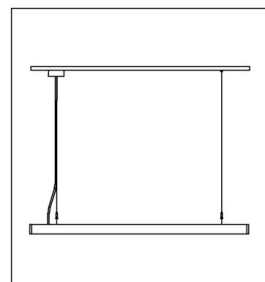
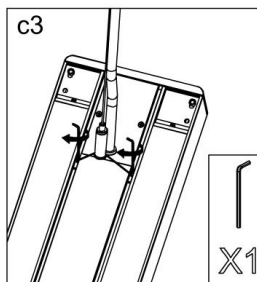
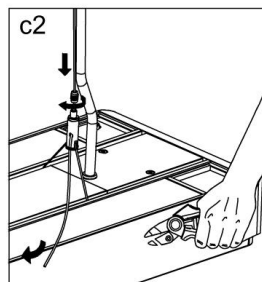
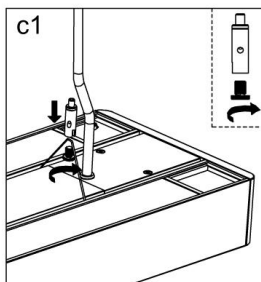
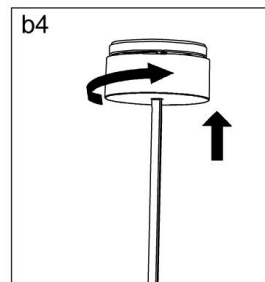
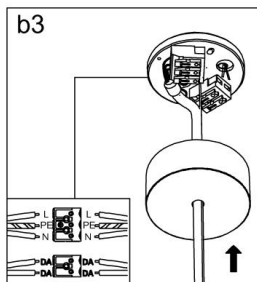
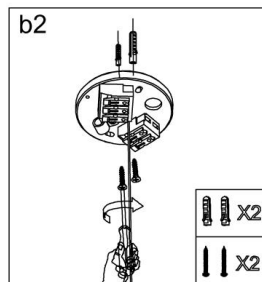
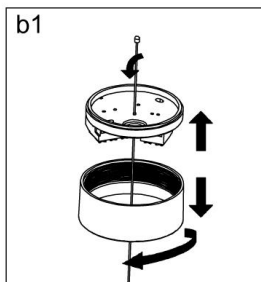
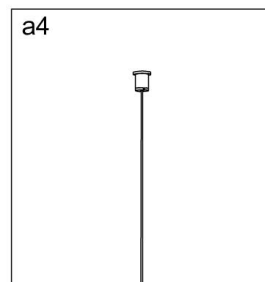
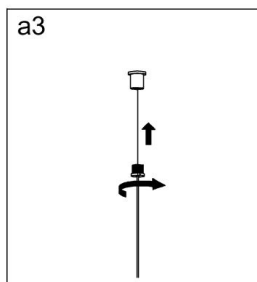
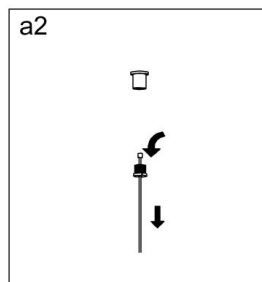
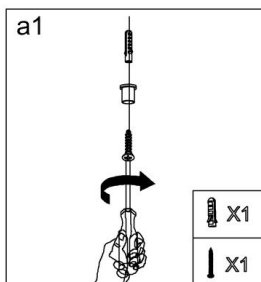
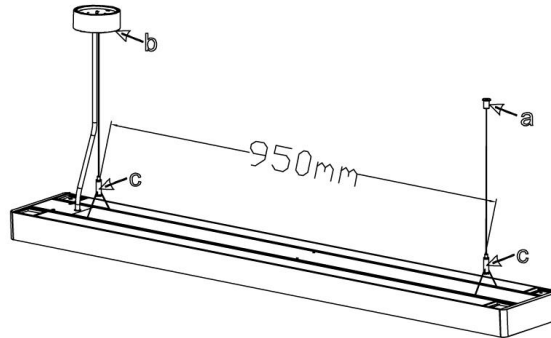
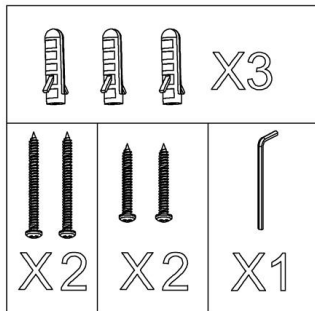

(DE) Die Lichtquelle dieser Leuchte ist nicht ersetzbar; wenn die Lichtquelle ihr Lebensdauerende erreicht hat, ist die gesamte Leuchte zu ersetzen.	(GB) The light source of this luminaire is not replaceable; when the light source reaches its end of life, the whole luminaire shall be replaced.
(FR) La source lumineuse de cette lampe n'est pas remplaçable. Lorsque celle-ci ne fonctionnera plus, il faudra alors procéder à un échange complet du luminaire.	(NL) De lichtbron van deze lamp is niet vervangbaar; wanneer de lichtbron het einde van zijn levensduur heeft bereikt, moet het complete armatuur vervangen worden.
(PL) Źródło światła w tej lampie jest niewymienne, gdy osiągnie koniec żywotności, należy wymienić całą oprawę.	(NO) Lyskilden i denne lampen er ikke mulig å bytte ut, når lyskildens livet tar slutt, må hele lampen skiftes ut.
(DK) Lyskilden til denne lampe kan ikke udskiftes; når lyskilden har nået enden på sin levetid, vil hele lampen skulle udskiftes.	(SE) Ljuskällan i denna lampa är inbyggd och är inte utbytbar. När ljuskällan når sitt slutt, får man byta ut hela armaturen.
(FI) Tämän valaisimen valonlähde ei voi vaihtaa. Kun valonlähde on tullut elinkaarensa päähän, on koko valaisin vaihdettava.	(IT) La sorgente luminosa di questa lampada non è sostituibile; quando la sorgente luminosa ha raggiunto la fine della sua vita utile, occorre sostituire l'intera lampada.
(ES) La fuente de luz de esta lámpara no es reemplazable. Cuando la fuente de luz haya llegado al final de su vida útil, tiene que reemplazarse toda la lámpara.	(CZ) Světelný zdroj nelze vyměnit, pokud světelný zdroj dosáhl konce své životnosti, je nutné vyměnit celé světlo.
(PT) A fonte de luz deste candeeiro não permite a substituição; quando a fonte de luz tiver atingido o fim de vida útil é necessário substituir o candeeiro completo.	(GR) Η πηγή φωτισμού αυτού του φωτιστικού δεν μπορεί να αντικατασταθεί. Όταν η πηγή φωτισμού φτάσει το τέλος της διάρκειας ζωής της, πρέπει να αντικαταστήσετε ολόκληρο το φωτιστικό.

Optional/ optional/ optionnel:

Durchgangsverdrahtung
Feed through wiring
Câblage traversant

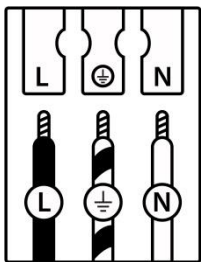
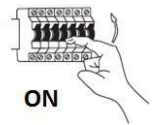
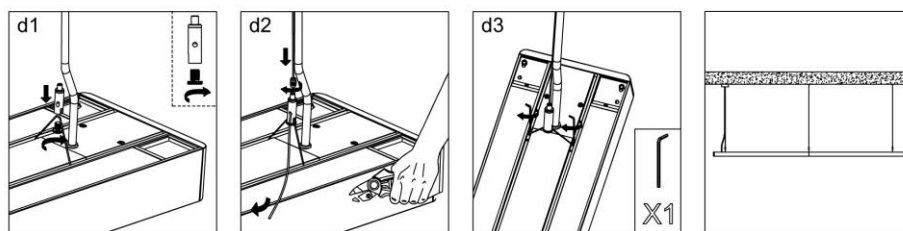
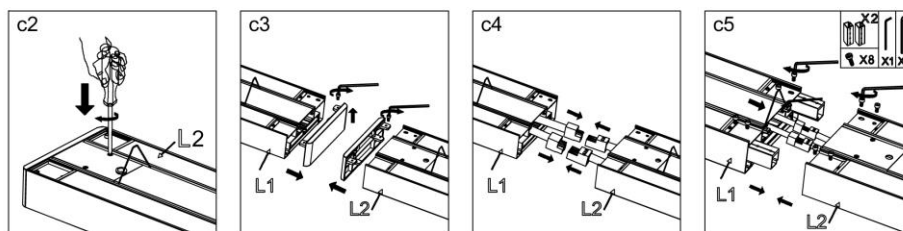
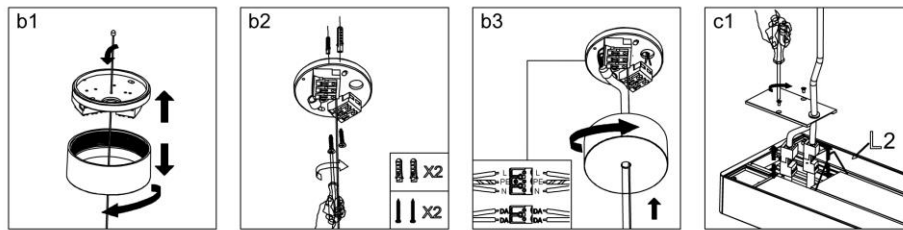
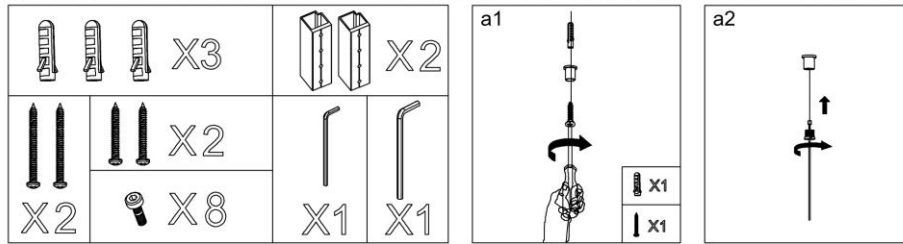
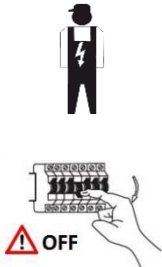
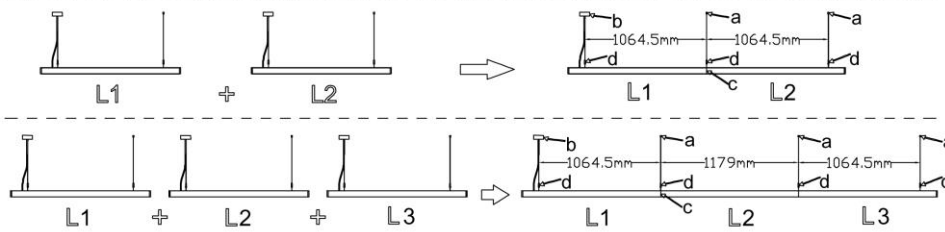
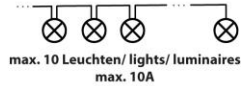

	(DE)	(GB)	(FR)	(NL)	(PL)	(NO)	(DK)
L	Stromführender Leiter	Live conductor	Conducteur	Spanningvoerende draad	Przewód prądowy	Strømførende leder	Strømførende leder
⊕	Schutzleiter	Earth conductor	Conducteur de protection (terre)	Aardkabel	Przewód uziemiający	Jordledningen	Jordledningen
N	Neutralleiter	Neutral conductor	Conducteur neutre	Nulleider	Przewód zerowy	Nøytralleder	Neutralleider
	(SE)	(FI)	(IT)	(ES)	(CZ)	(PT)	(GR)
L	Strömförande ledare	Virtajohdin	Conduttore sotto tensione	Líneas conductoras de corriente	Vodič pod napětím	Condutor vivo	Ρευματοφόρος αγωγός
⊕	Skyddsledare	Suojajohdin	Conduttore di terra	Conductor de protección	Ochranný vodič	Condutor de terra	Αγωγός γείωσης
N	Neutralledare	Nollajohdin	Conduttore neutro	Conductor neutro	Neutrální vodič	Condutor neutro	Ουδέτερος αγωγός