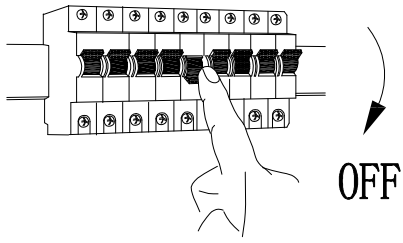
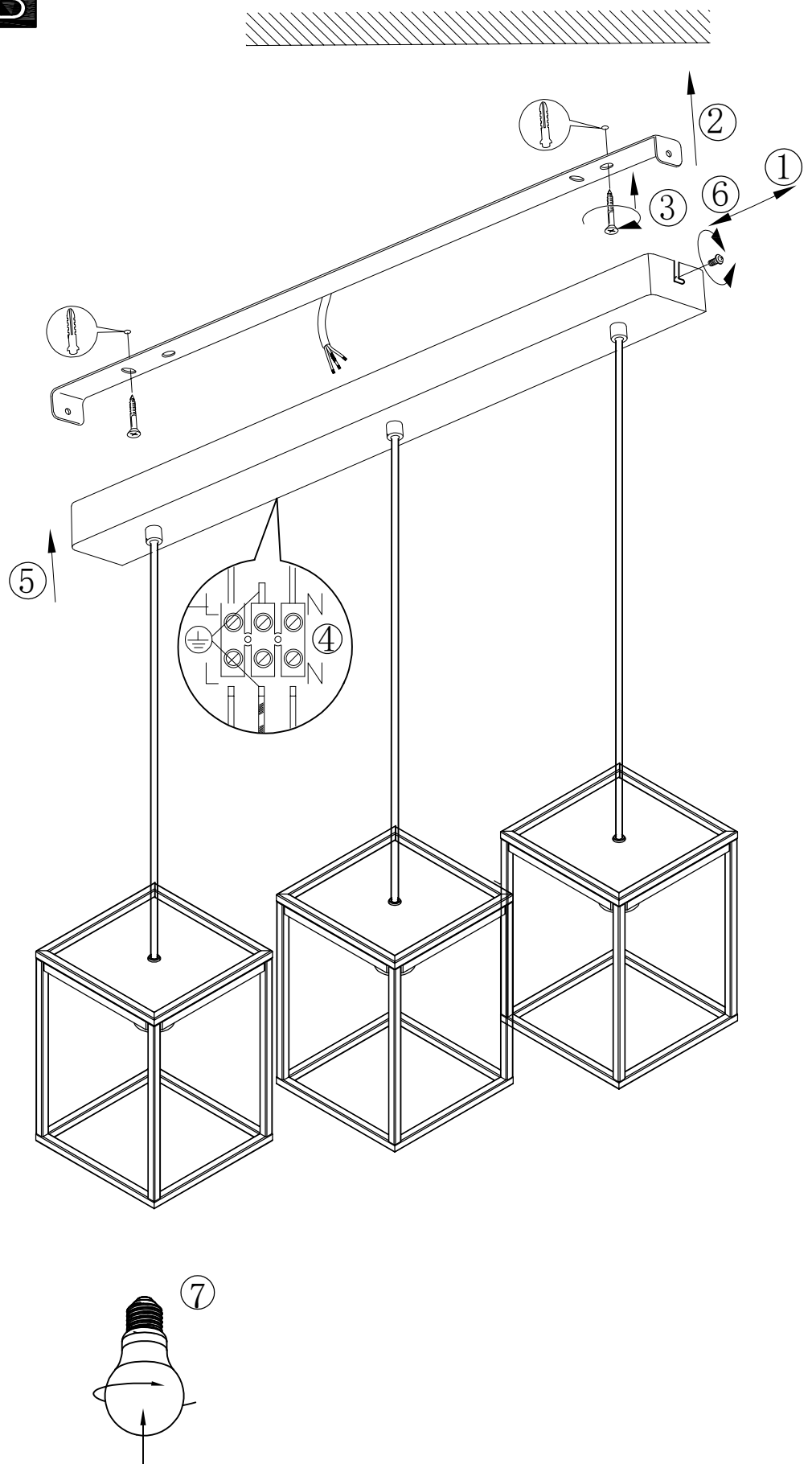
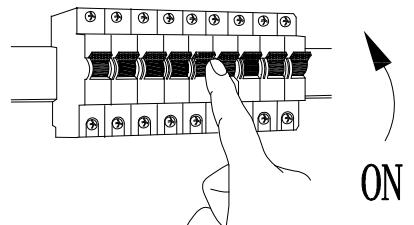

A**B****C**

BLA99855
www.eglo.com