

MESH

design Francisco Gomez Paz

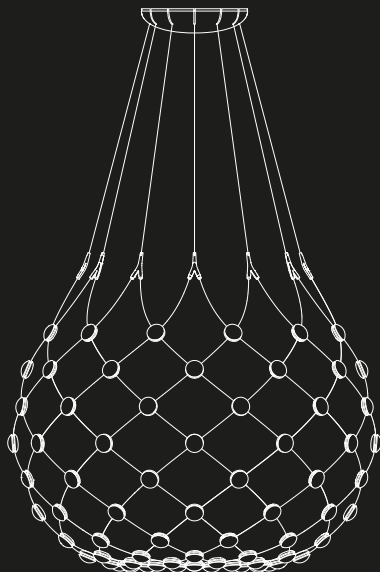

**LUCE
PLAN**

D86KT..081...082...083...084...085

D86KT..101...102...103...104...105



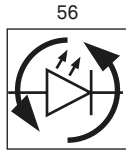
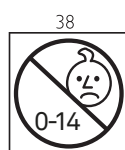
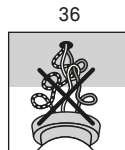
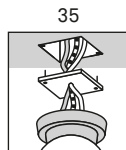
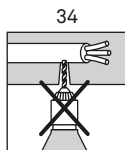
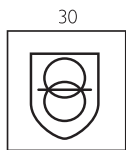
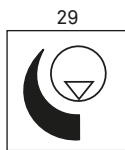
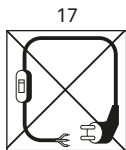
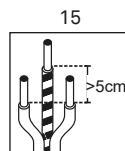
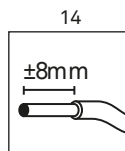
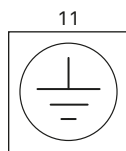
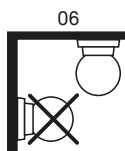
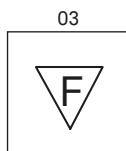
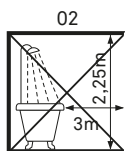
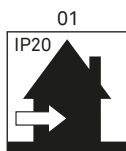

D86KT101
D86KT102
D86KT103
D86KT104
D86KT105

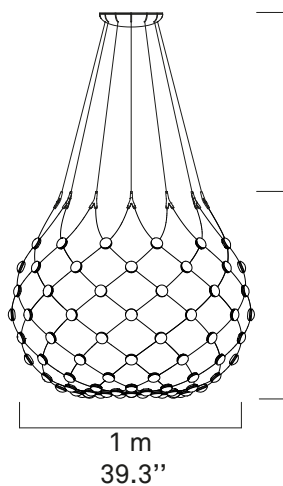

1 m - 39,4"
2 m - 78,7"
3 m - 118,1"
4 m - 157,5"
5 m - 196,8"

0,9 m
35,4"

kg 7kg

lb 15,4lb

D86KT081
D86KT082
D86KT083
D86KT084
D86KT085

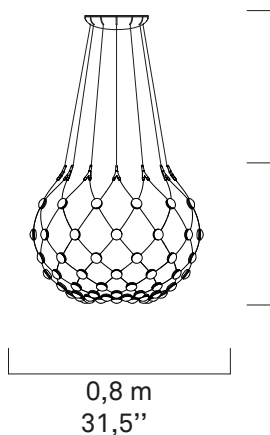

1 m - 39,4"
2 m - 78,7"
3 m - 118,1"
4 m - 157,5"
5 m - 196,8"

0,6 m
23,6"

kg 5,6kg

lb 12,3lb

D86KT101
D86KT102
D86KT103
D86KT104
D86KT105

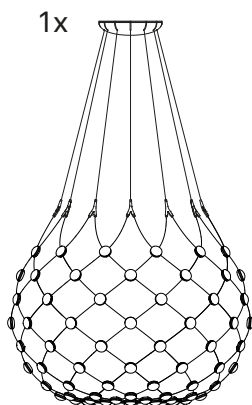

a



b

D86KT081
D86KT082
D86KT083
D86KT084
D86KT085

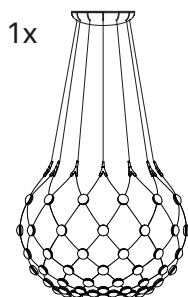

a



b

1

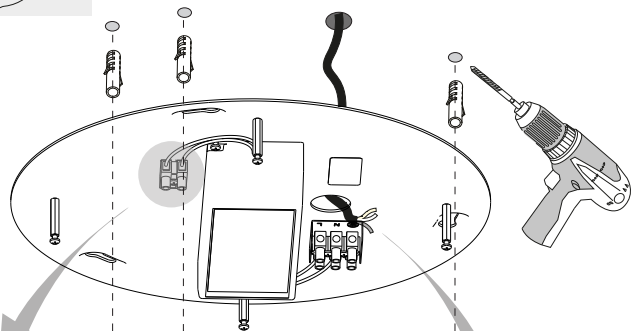
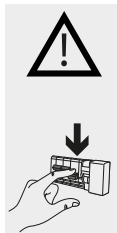

1.1

1.2

Click!

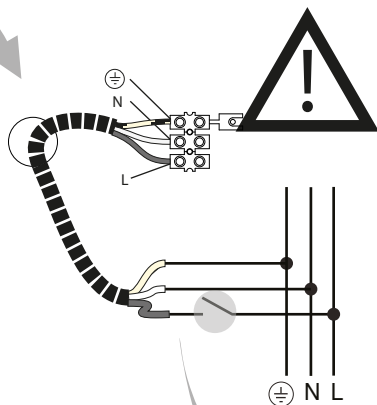
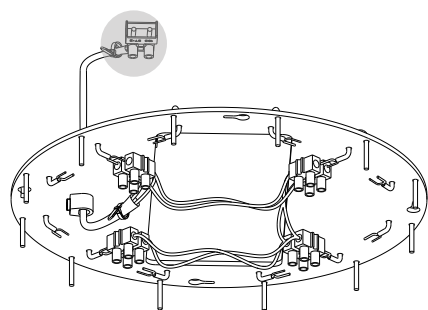

29



(0,1%)   MAX (100%)

2

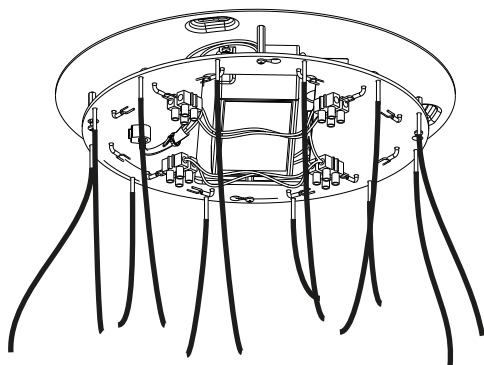
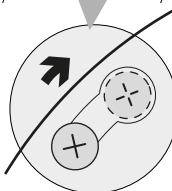
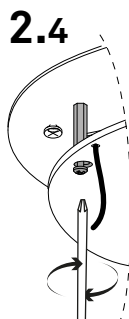
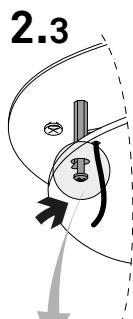
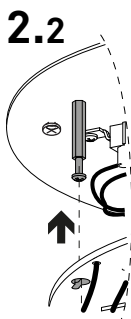
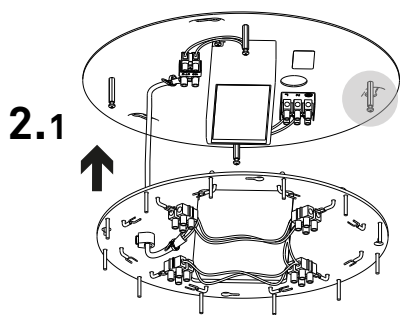

3

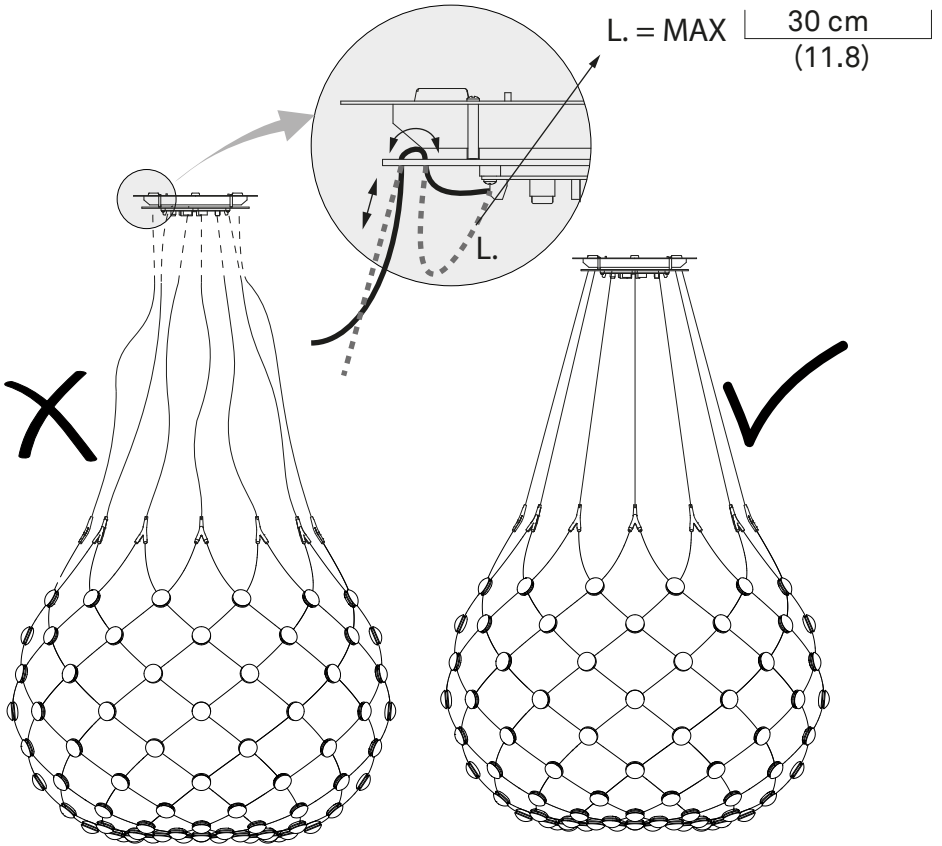

4

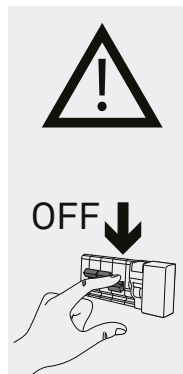
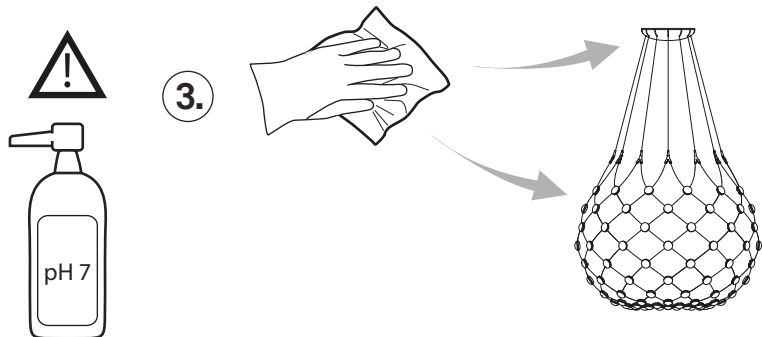
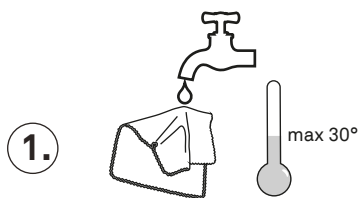
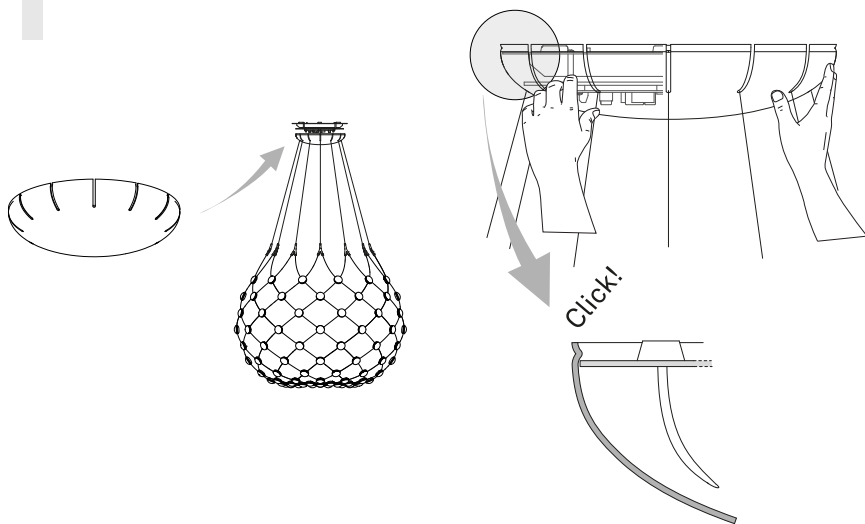



www.luceplan.com

D860I0010