

INSTALLATION INSTRUCTIONS EN

The advice of a qualified person may be required for installation.
The product can be used outdoors if the luminaire shows the symbol IP44 or IP54, otherwise the product should only be used indoors. The lighting fitting with wooden elements may be installed only in heated rooms.
It is recommended to use a YDY 3 x 1.5 mm² power cord with a double sheath.

RECOMMENDED LIGHT SOURCE: E27, 15W-20W LED BULB

Installation:



1. Disconnect the power supply.
2. Take the stand as shown in figure 1 below.
3. Strip 6 mm of the power supply cables and pass them through the cable gland provided with a grommet.
4. Screw the luminaire to the base using appropriately selected screws.
5. Connect the power cables to the correspondingly marked terminals on the connector - phase wire (L) brown and neutral wire (N) blue. Picture 2.
6. Connect the protective conductor (green and yellow) to the protective terminal marked with the symbol  on the metal base inside the fitting. Picture 2.
7. Place the lampshade in the housing with the mat side down.
8. Install the bulbs and screw the housing as shown in Fig. 4.

The light source used in this luminaire should be replaced only by the manufacturer or its service agent or a similarly qualified person.

Maintenance:

Maintenance works should be performed with the power supply disconnected and after waiting for the LED panel to cool down.

After disassembling the cover and disconnecting the power supply, clean it with a soft cloth.

	- selective collecting of electrical equipment	
	- luminaire powered by alternating current	
		- luminaire for ceiling and wall mounting

2-year warranty:

1. The warranty covers a period of 2 years from the date of purchase in Poland and is valid only with the purchase document - receipt or invoice.
2. The warranty does not cover damage caused by overvoltage, lightning strikes and mechanical damage.
3. The warranty is valid only if the luminaire has been installed by a person with appropriate electrical qualifications and covers the repair or replacement of the product with a product free from defects or a refund of the amount paid.
4. In the event of a defect, the product should be sent to the following address: Temar sp.z o.o. , 39-300 Mielec, ul. 12 inwestor or pay back at the point of purchase. The repair should not take more than 14 business days.
5. The guarantee does not exclude, limit or suspend the rights of the buyer resulting from the provisions on the warranty for defects in the sold item.

1 15-20W LED E27

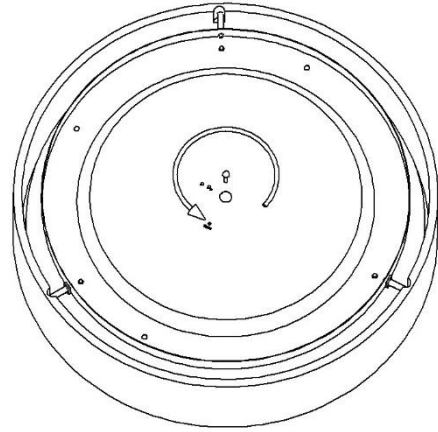

2

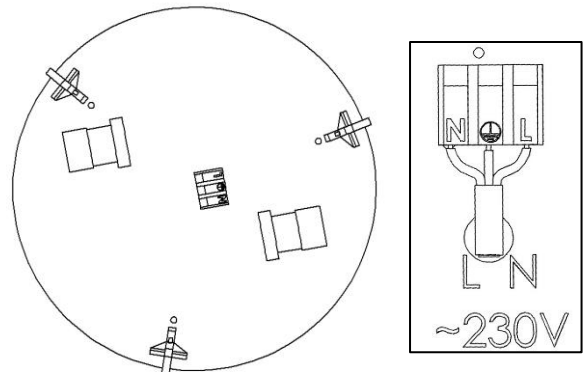

3

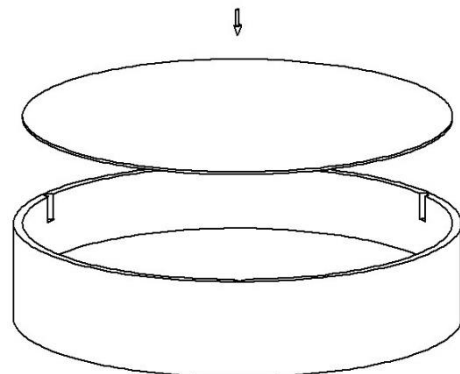

4

