

# MESH

design Francisco Gomez Paz

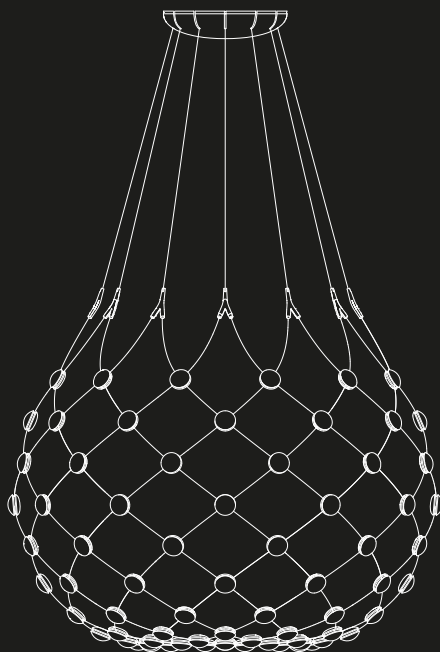

**LUCE  
PLAN**

D86KW..081...082...083...084...085

D86KW..101...102...103...104...105



a

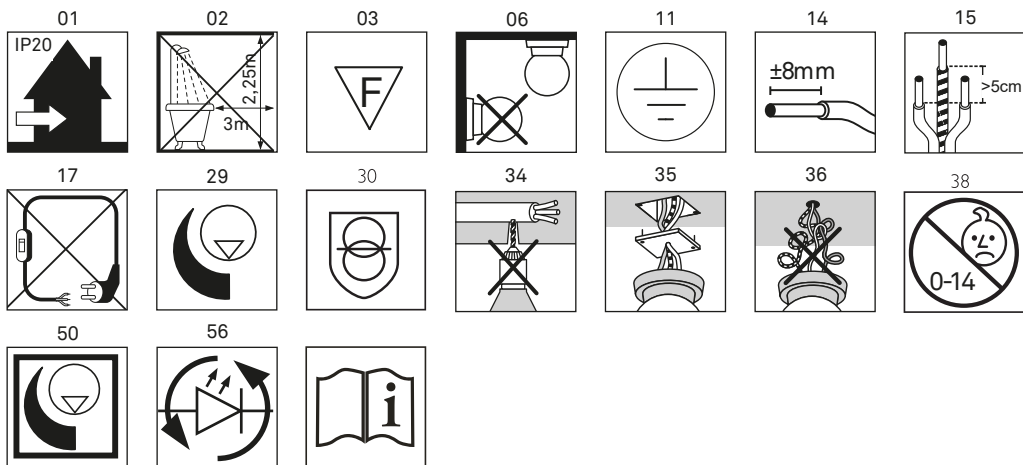

D86KW101  
D86KW102  
D86KW103  
D86KW104  
D86KW105

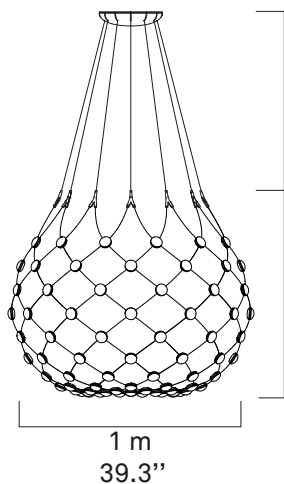

1 m - 39,4"  
2 m - 78,7"  
3 m - 118,1"  
4 m - 157,5"  
5 m - 196,8"

0,9 m  
35,4"

1 m  
39.3"

**kg** 7kg

**lb** 15,4lb

D86KW081  
D86KW082  
D86KW083  
D86KW084  
D86KW085

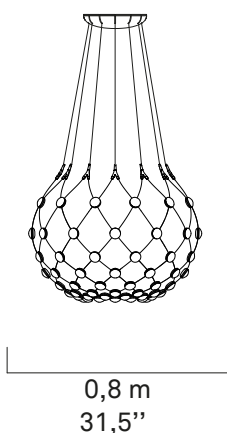

1 m - 39,4"  
2 m - 78,7"  
3 m - 118,1"  
4 m - 157,5"  
5 m - 196,8"

0,6 m  
23,6"

0,8 m  
31,5"

**kg** 5,6kg

**lb** 12,3lb

D86KW101  
D86KW102  
D86KW103  
D86KW104  
D86KW105



a



b

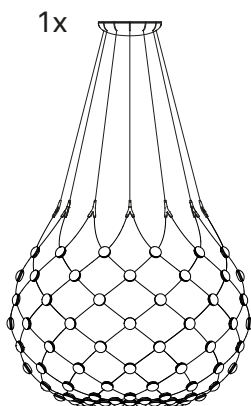

D86KW081  
D86KW082  
D86KW083  
D86KW084  
D86KW085



a



b

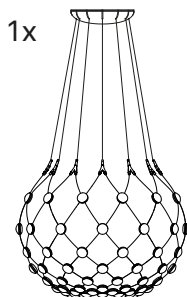

# 1



## 1.2



## 1.1

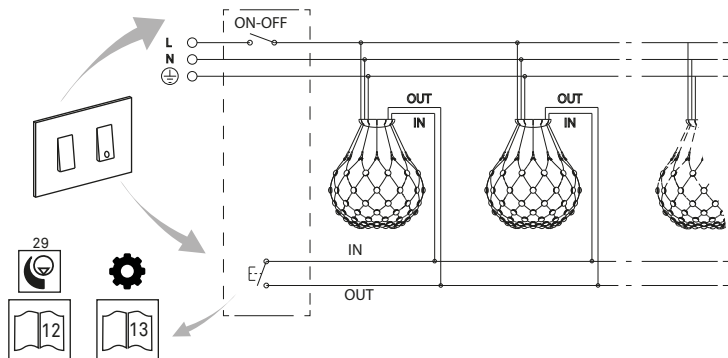
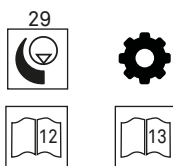
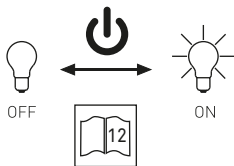
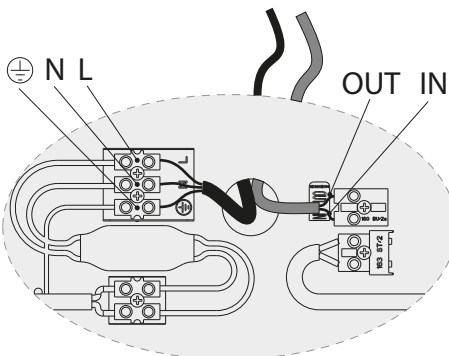
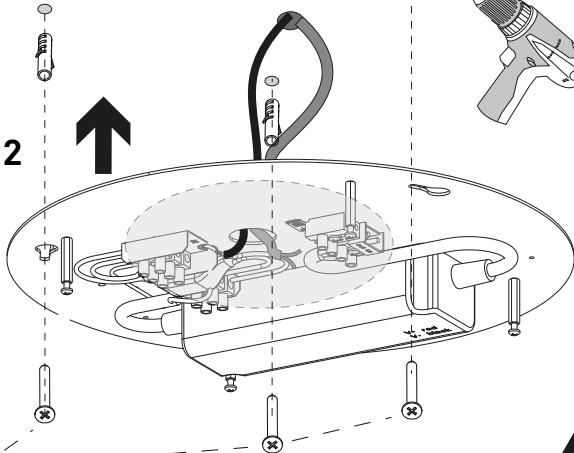
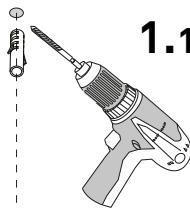

2



2.1

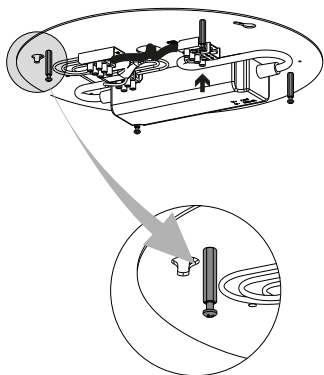
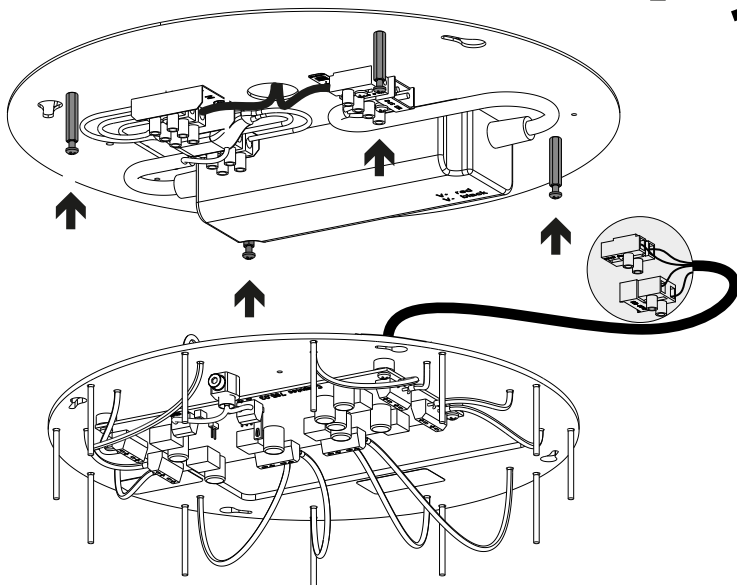
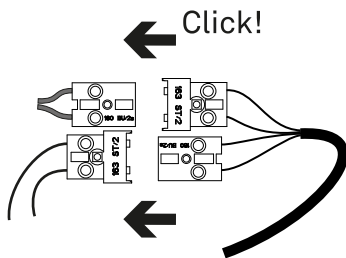

2.2

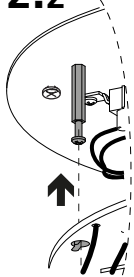

2.3

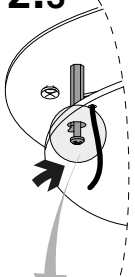

2.4

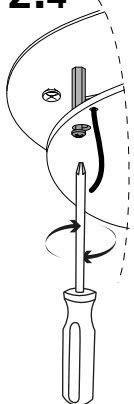

# 3

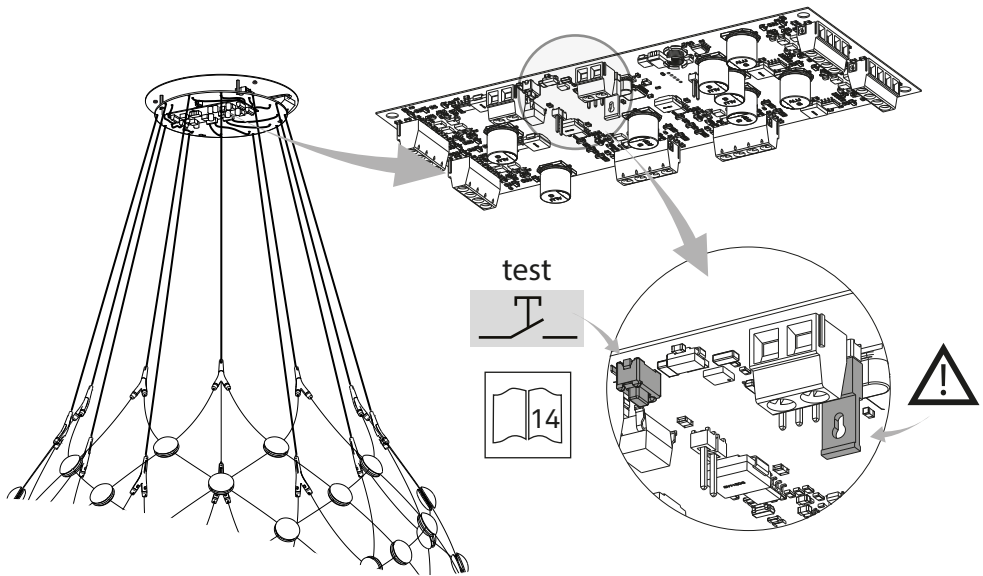
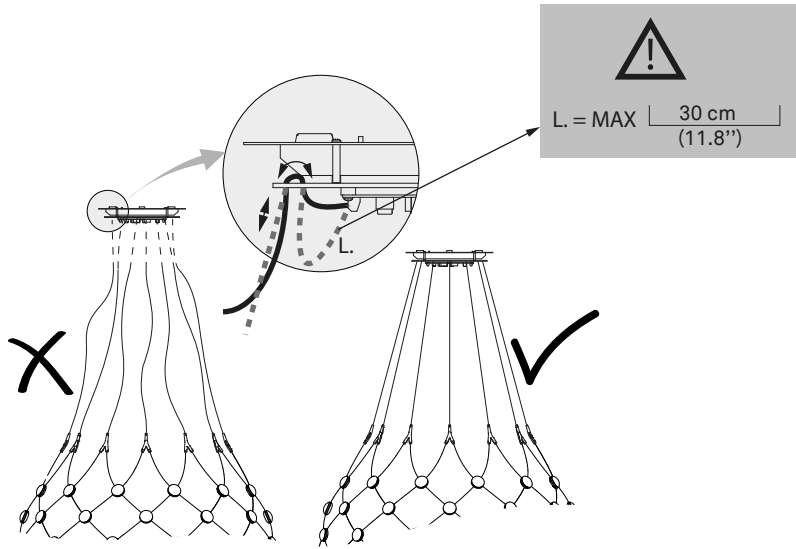

# 4

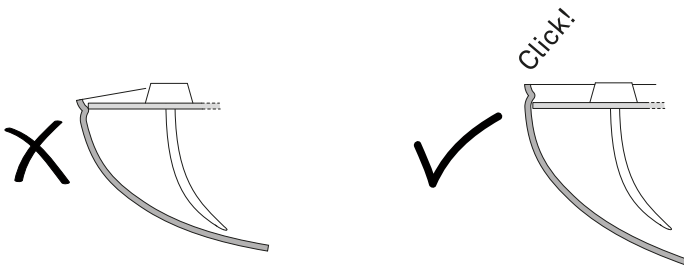
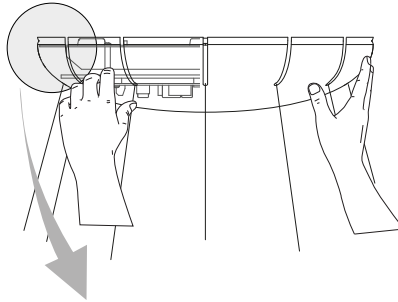
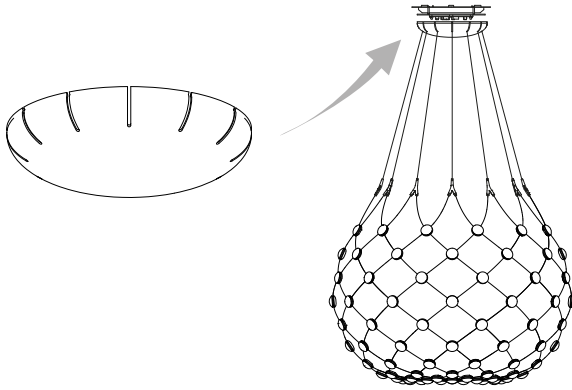

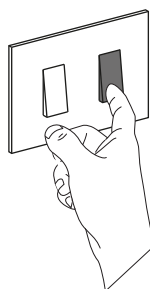
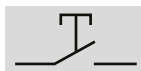
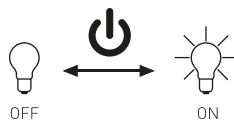
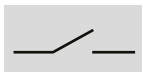

5

D86KT081...082...083...084...085  
D86KT101...102...103...104...105

&gt; 1s

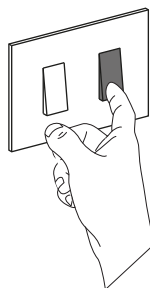

&gt; 1s



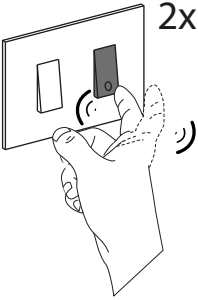
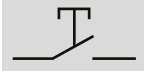

$2x < 1s$

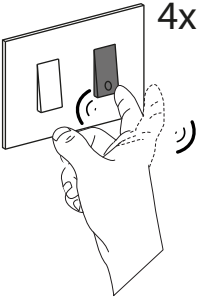
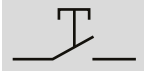
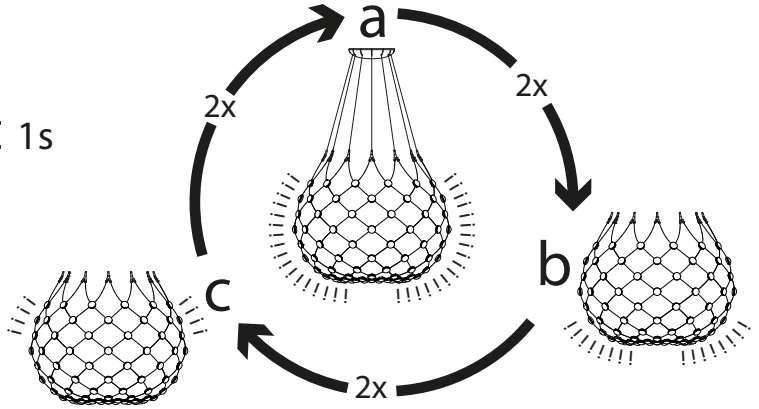

$4x < 1s$



$4x < 1s$

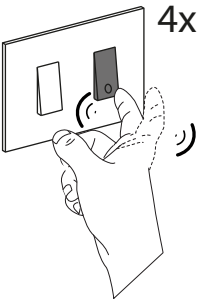
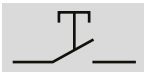
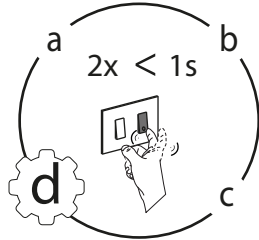

$4x < 1s$

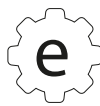

$4x < 1s$

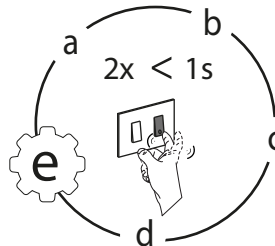

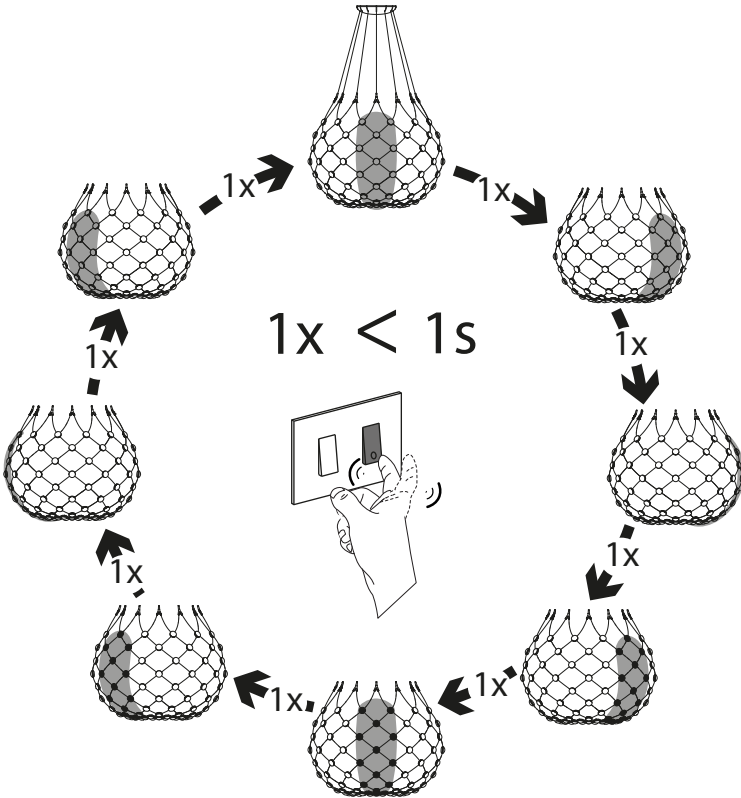
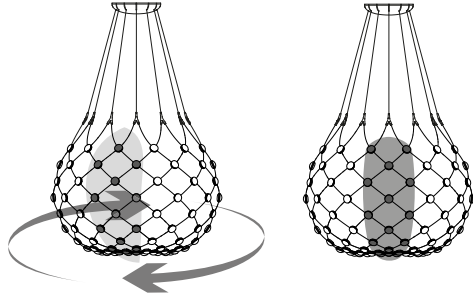
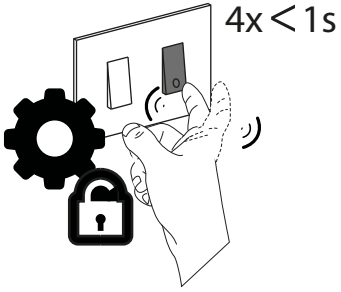

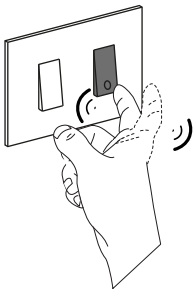
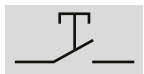
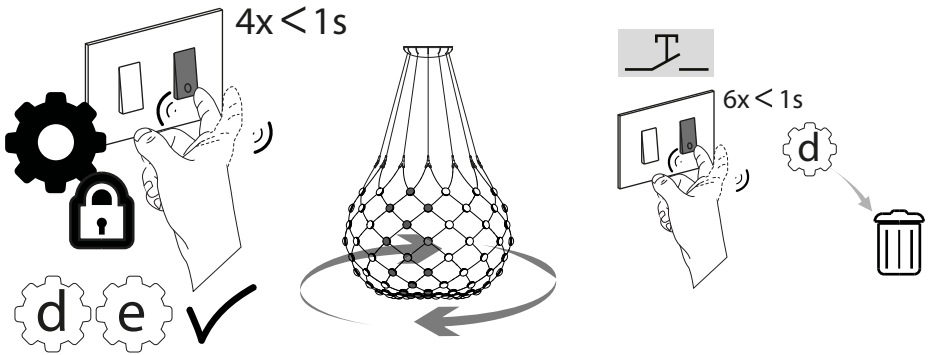
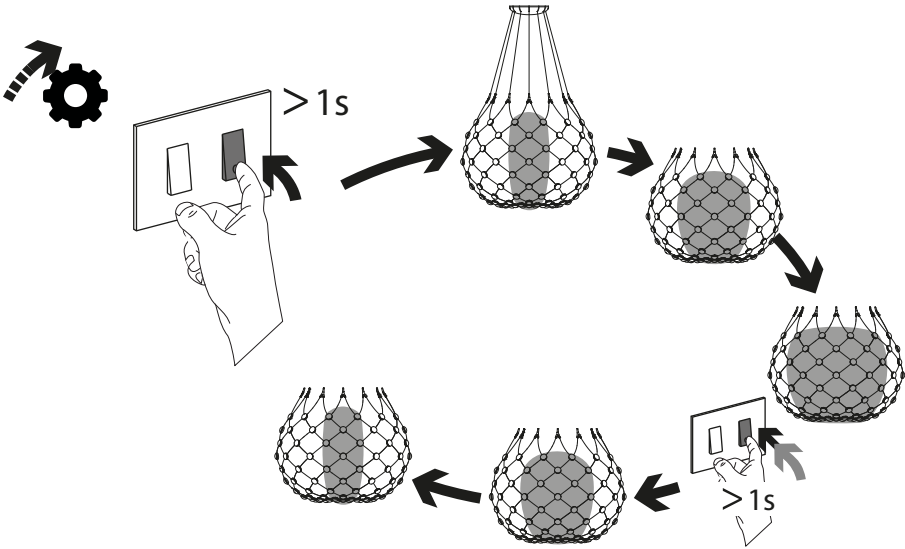

3x < 1s

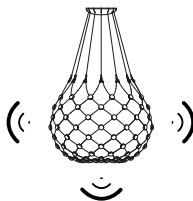

2x < 1s



1.



2.



3.

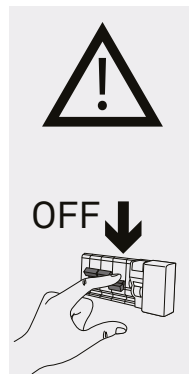
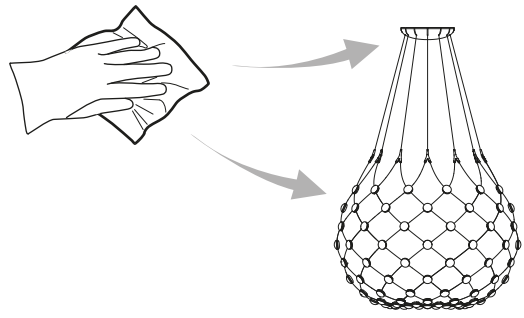







[www.luceplan.com](http://www.luceplan.com)

D860I0011