

10012945

2,4W LED / 4W Total
incl. 0,53x LED Board: L9002709
5Vdc (constant voltage)

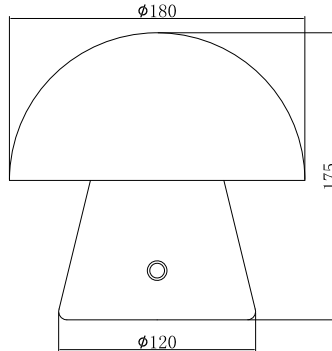

Maßeinheit/Unit of measure/ Unité de mesure: mm

(DE) Bestimmungsgemäße Verwendung

(GB) Intended use / (FR) Utilisation conforme / (NL) Beoogd gebruik / (PL) Stosowanie zgodnie z przeznaczeniem / (NO) Riktig bruk / (DK) Korrekt brug / (SE) Avsedd användning / (FI) Määräystenmukainen käyttö

(IT) Impiego appropriato / (ES) Uso prescrito / (CZ) Použití v souladu s určením / (PT) Utilização correta / (GR) Ενδεικτική χρήση

(DE)	Als Tischleuchte im Innenbereich	(GB)	Provided for use as table lamp, indoors
(FR)	En tant que lampe à poser, à l'intérieur	(NL)	Als tafellamp binnenshuis
(PL)	Jako lampa stołowa do wnętrz	(NO)	Som bordlampe innendørs
(DK)	Som bordlampe indendørs	(SE)	Används som bordslampa inomhus
(FI)	Käyttö sisätilojen pöytävalaisimena	(IT)	Impiego come lampada da tavolo in ambienti interni
(ES)	Empleo en tanto lámpara de mesa en interiores	(CZ)	Použití jako stolní lampa v interiéru
(PT)	Aplicação como candeeiro de mesa em interiores	(GR)	Χρήση ως επιτραπέζιο φωτιστικό σε εσωτερικό χώρο

(DE) Verwendete Symbole

(GB) Safety Precautions / (FR) Symboles utilisés / (NL) Gebruikte symbolen / (PL) Stosowane symbole / (NO) Brukte symboler / (DK) Brugte symboler / (SE) Använda symboler / (FI) Käytetyt symbolit / (IT) Simboli usati / (ES) Símbolos empleados / (CZ) Použité symboly / (PT) Símbolos utilizados / (GR) Χρησιμοποιούμενα σύμβολα

IP 20

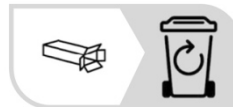

(DE) Lieferumfang

(GB) Package contents / (FR) Contenu de la livraison / (NL) Bij de levering inbegrepen / (PL) Zakres dostawy / (NO) Levering / (DK) Leveringsomfang / (SE) Leveransomfattning / (FI) Toimitussisältö / (IT) Fornitura / (ES) Volumen de suministro / (CZ) Rozsah dodávky / (PT) Material fornecido / (GR) Παραδοτέος εξοπλισμός

(DE)	1 Tischleuchte Montagematerial Montageanleitung	(GB)	1 Table lamp Installation hardware Mounting instructions	(FR)	1 Lampe à poser Matériel de montage Instructions de montage
(NL)	1 Tafellamp Monteringsmateriale Montagehandleiding	(PL)	1 Lampa stołowa Elementy montażowe Instrukcja montażu	(NO)	1 Bordlampe Monteringsmateriale Brukerveiledning
(DK)	1 Bordlampe Monteringsmateriale Brugervejledning	(SE)	1 Bordslampa Monteringsmaterial Monteringsanvisning	(FI)	1 Pöytävalaisin Asennusmateriaali Asennusohjeet
(IT)	1 Lampada da tavolo Materiale di montaggio Istruzioni di montaggio	(ES)	1 Lámpara de mesa Material de montaje Instrucciones de montaje	(CZ)	1 Stolní lampa Materiál pro montáž Návod k montáži
(PT)	1 Candeeiro de mesa Material de montagem Instruções de montagem	(GR)	1 Επιτραπέζιο φωτιστικό Υλικά συναρμολόγησης Οδηγίες συναρμολόγησης		

A

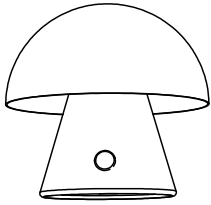

B

X1

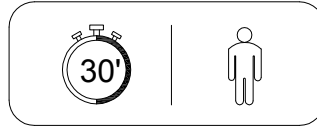

A

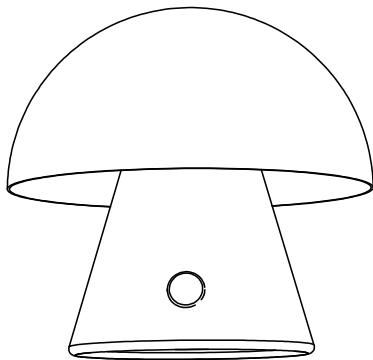

1

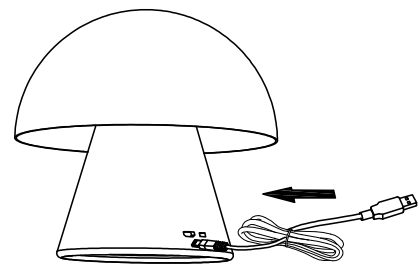
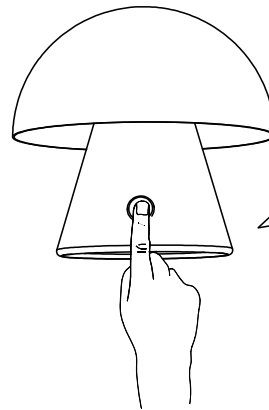

B

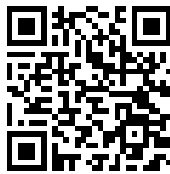

X1

<p>(DE) Dieses Produkt enthält eine Lichtquelle der Energieeffizienzklasse E (EN) This product contains a light source of energy efficiency class E (FR) Ce produit comprend une source de lumière de classe d'efficience énergétique E (NL) Dit product bevat een lichtbron van energie-efficiëntieklasse E (PL) Produkt ten zawiera źródło światła o klasie efektywności energetycznej E (NO) Dette produktet inneholder en lyskilde i energieeffektivitetsklasse E (DK) Dette produkt indeholder en lyskilde af energieeffektklasse E (SE) Denna produkt innehåller en ljuskälla i energieffektivitetsklass E (FI) Tämä tuote sisältää energiatehokkuusluokan E valonlähteen (IT) Questo prodotto contiene una sorgente luminosa della classe di efficienza energetica E (ES) Este producto contiene una fuente de luz de la clase de eficiencia energética E (CZ) Tento výrobek obsahuje světelný zdroj třídy energetické účinnosti E (PT) Este produto contém uma fonte de luz da classe de eficiência energética E (GR) Αυτό το προϊόν περιέχει μια φωτεινή πηγή ενεργειακής απόδοσης κλάσης E (SK) Tento výrobok obsahuje zdroj svetla triedy energetickej efektivity E</p>	QR	EAN
		<p>4251911770919</p>

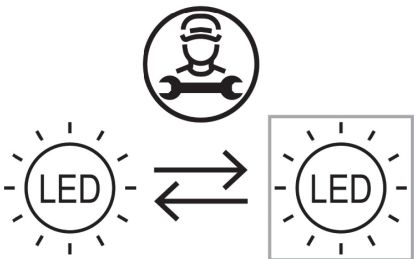
	<p>(DE) Durch einen Fachmann austauschbare Lichtquelle (nur LED). (EN) Replaceable (LED only) light source by a professional. (FR) Source de lumière remplaçable (LED uniquement) par un professionnel. (NL) Lichtbron (alleen led) te vervangen door een professional. (PL) Wymienne (tylko LED) źródło światła wykonane przez profesjonalistę. (NO) Utskiftbar (kun LED) lyskilde av en profesjonell. (DK) Udskiftelig lyskilde (kun LED), udskiftes af en elektriker. (SE) Ljuskälla (endast LED) utbytbar genom fackman. (FI) Ammattilainen voi vaihtaa vaihdettavan (vain LED) valonlähteen. (IT) Sorgente luminosa (solo LED) sostituibile da un professionista. (ES) Fuente de luz (solo LED) sustituible por un profesional. (CZ) Vyměnitelný (pouze LED) světelný zdroj odborníkem. (PT) Luz LED (apenas LED) substituível por um profissional. (GR) Η πηγή φωτός (μόνο LED) να αντικαθίσταται από επαγγελματία. (SK) Zdroj svetla (iba LED) vymeniteľný prostredníctvom odborníka.</p>
--	---

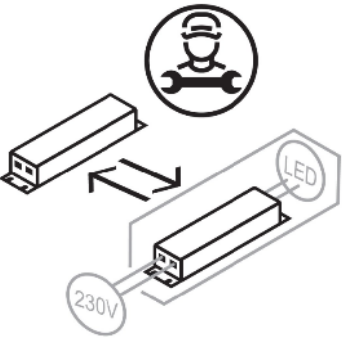
	<p>(DE) Durch einen Fachmann austauschbares Betriebsgerät. (EN) Replaceable control gear by a professional. (FR) Contrôleur remplaçable par un professionnel. (NL) Voorschakelapparatuur te vervangen door een professional. (PL) Wymienny układ sterujący przez profesjonalistę. (NO) Utskiftbar kontrollutstyr av en profesjonell. (DK) Udskiftelig igangsætter, udskiftes af en elektriker. (SE) Styrdon utbytbar genom fackman. (FI) Ammattilainen voi vaihtaa vaihdettavat ohjauslaitteet. (IT) Dispositivo di controllo sostituibile da un professionista. (ES) Dispositivo de control sustituible por un profesional. (CZ) Vyměnitelný předřadník odborníkem. (PT) Dispositivo de controlo substituível por um profissional. (GR) Ο εξοπλισμός ελέγχου να αντικαθίσταται από επαγγελματία. (SK) Predradník vymeniteľný prostredníctvom odborníka.</p>
---	---