

# Artemide®

## Tolomeo mega

design  
M. De Lucchi  
G. Fassina

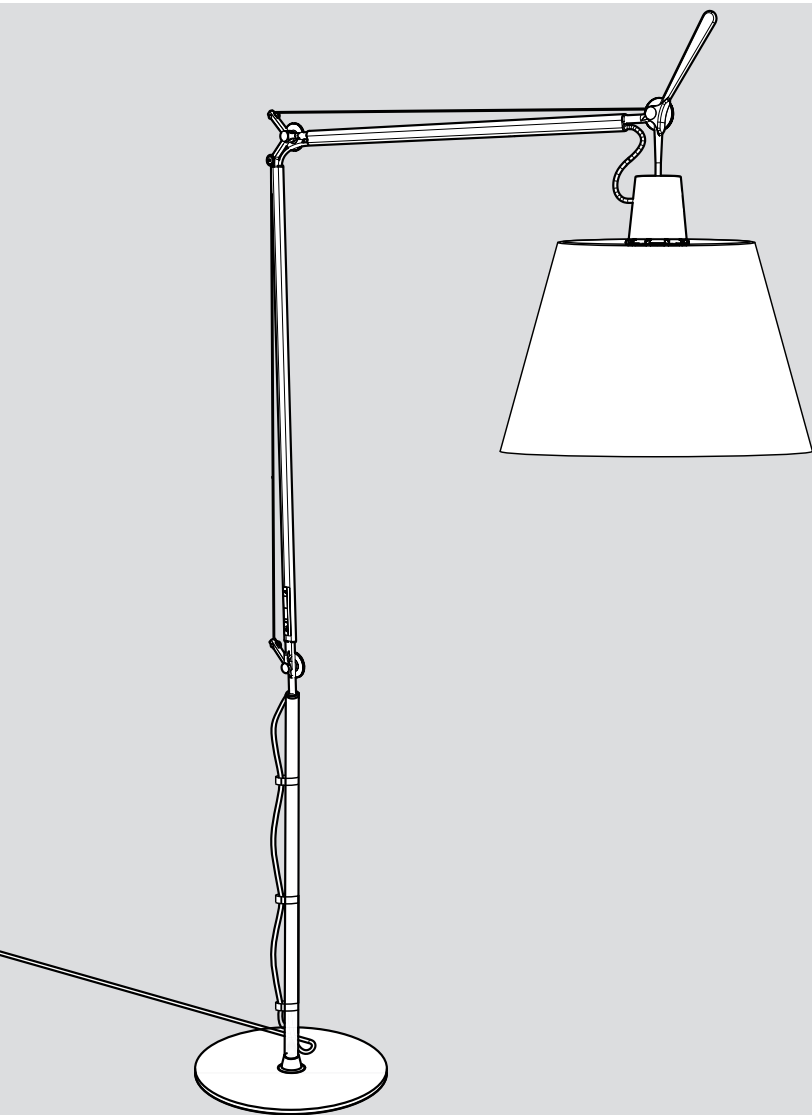



i

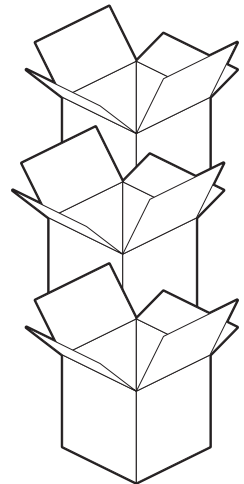
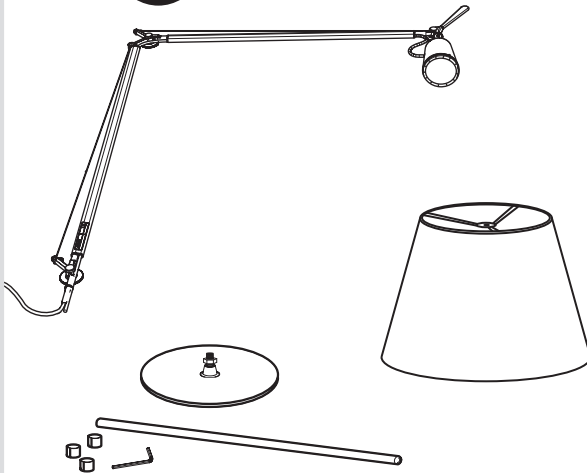
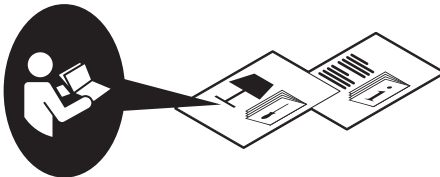
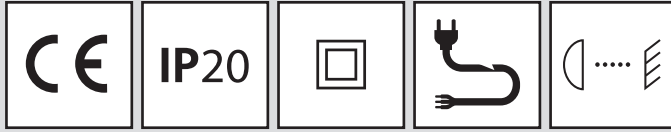

1

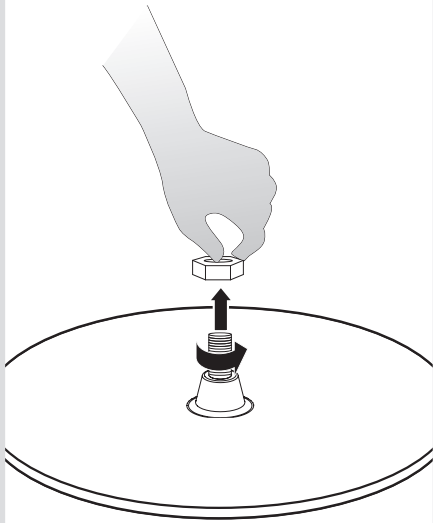

2

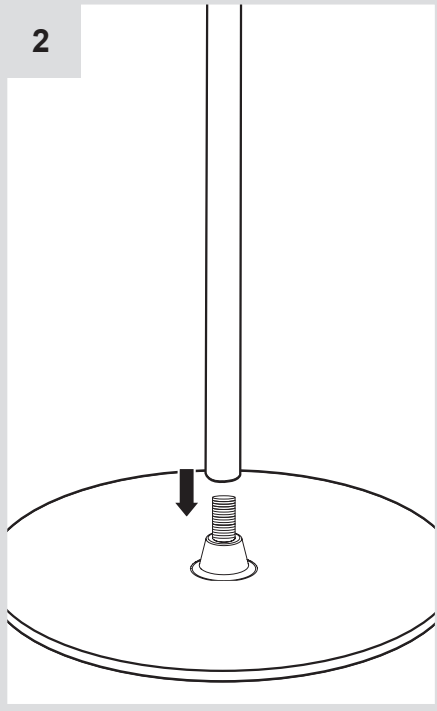

3

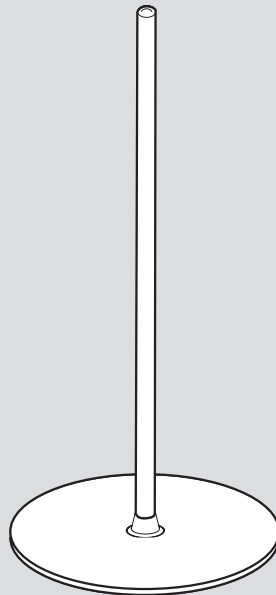
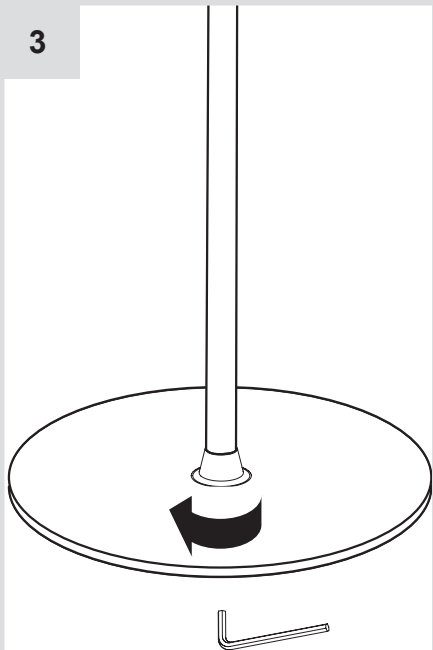

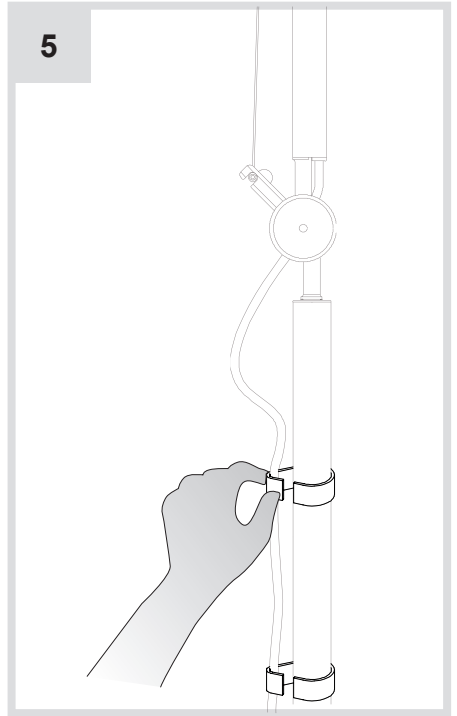
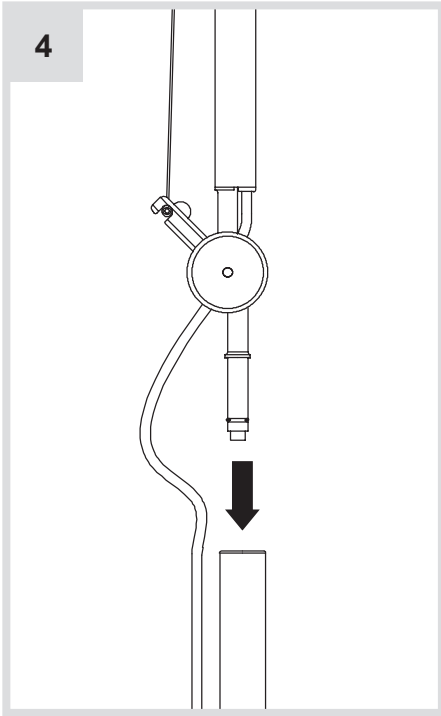

6

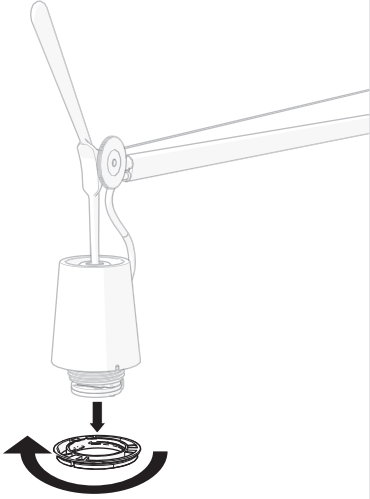

7

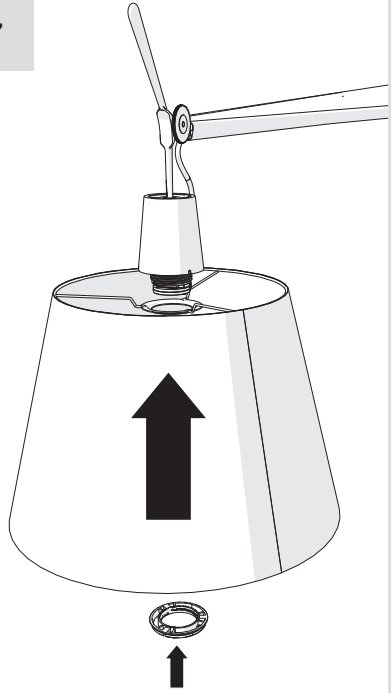

8

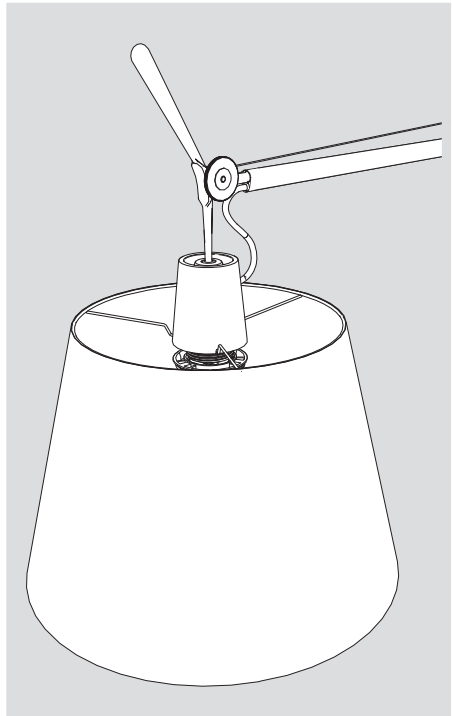
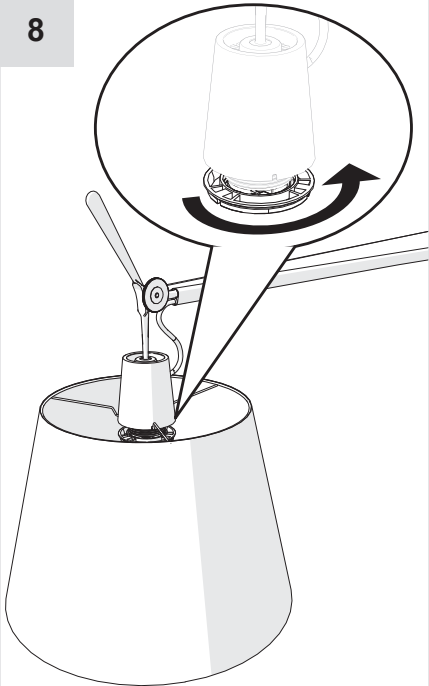

9

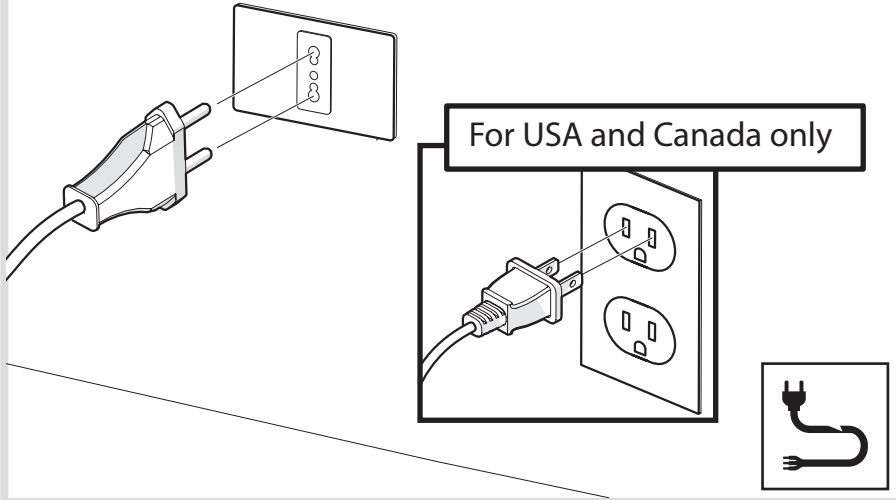

i



**i**

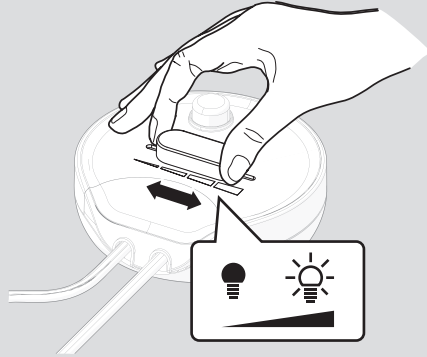
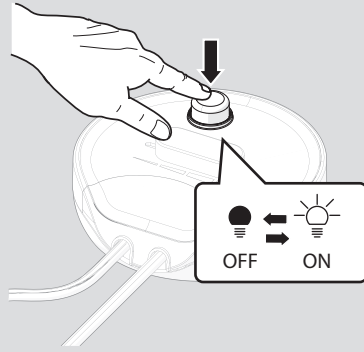

**i**

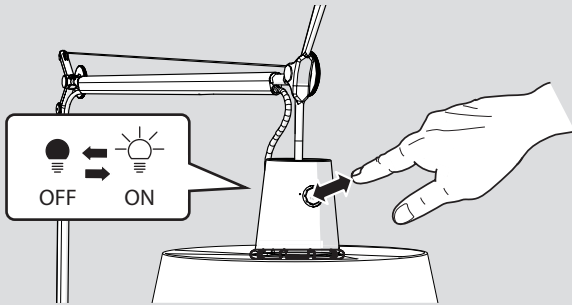

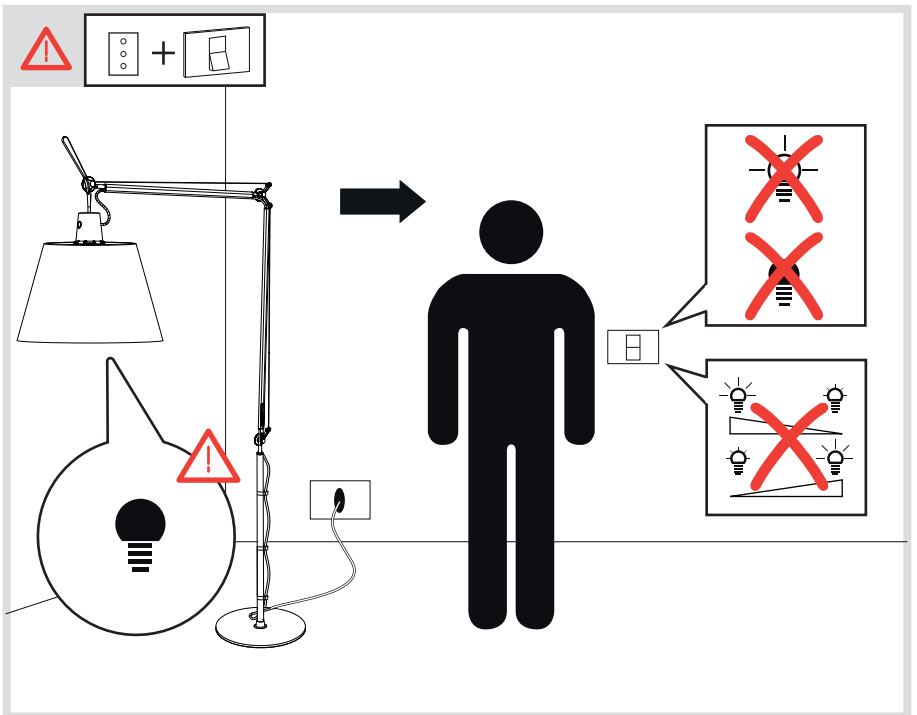
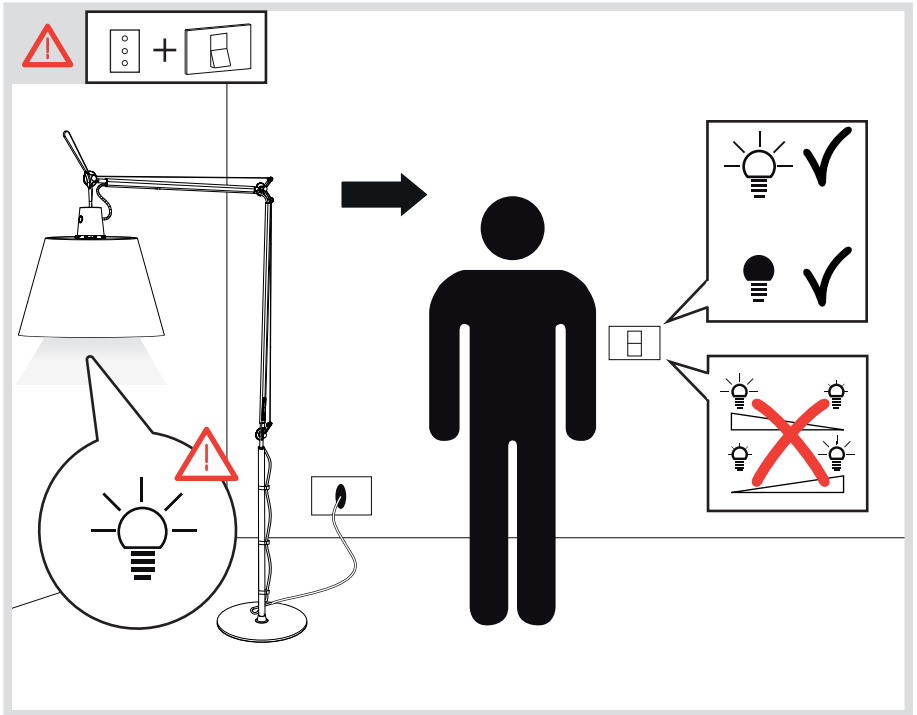





**i**

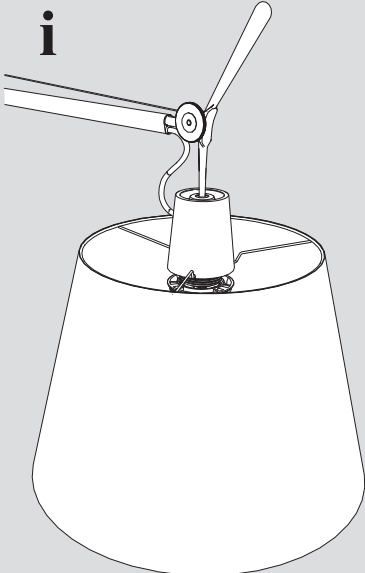

	}					
<table border="1"><tr><td></td><td><b>MAX 21W LED E27</b></td></tr><tr><td></td><td><b>MAX 150W E27</b></td></tr><tr><td></td><td><b>MAX 150W E27</b></td></tr></table>			<b>MAX 21W LED E27</b>		<b>MAX 150W E27</b>	
	<b>MAX 21W LED E27</b>					
	<b>MAX 150W E27</b>					
	<b>MAX 150W E27</b>					

**for USA/CANADA only**

	<b>MAX 21W E26</b> cULus SBLED LAMP
	<b>MAX 150W E26</b> type A
	<b>MAX 150W E26</b> type A

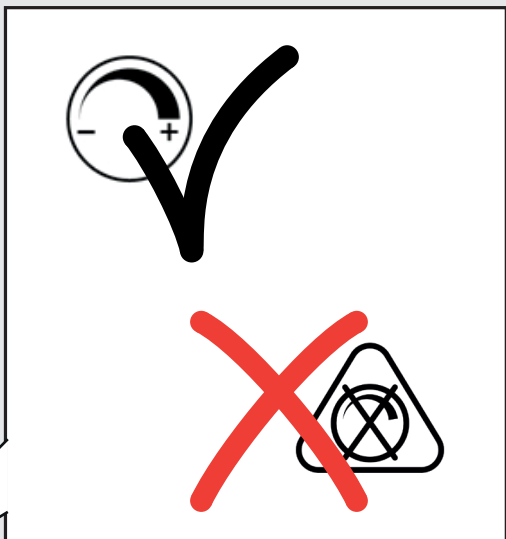
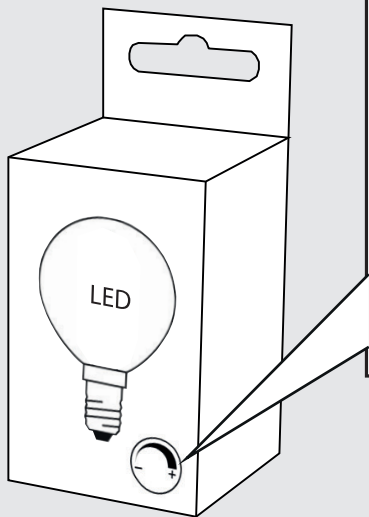



# Artemide®



## **Artemide**

via Bergamo, 18  
20010 Pregnana M.se (MI)  
ITALIA

tel. +39 02 935 181  
fax +39 02 935 90 254  
fax +39 02 935 90 496

[www.artemide.com](http://www.artemide.com)

VAT IT00846890150

## **Artemide Inc.**

250 Karin Lane  
Hicksville, NY 11801

Tel. 631 694 9292  
Toll Free 1-877-Art-9111  
Fax 631 694 9275

[www.artemide.net](http://www.artemide.net)

## **Artemide Ltée/Ltd.**

11105 rue Renaude Lapointe  
Montréal, Québec H1J 2T4

Tel. 514 323 6537  
Toll Free 888 777 2783  
Fax 514 323 8864

[www.artemide.net](http://www.artemide.net)

cod. Y513001192