



EN DuoFern Room Thermostat 9485
Instruction manual for the electrical connection and for commissioning

Item no. 3250 18 12

Type: 9485



You have chosen a quality product manufactured by RADEMACHER with your purchase of a **DuoFern Room Thermostat 9485**. Thank you for the trust you have placed in us.

RADEMACHER products have been developed with the greatest possible convenience in mind. Having applied uncompromising quality standards and thorough testing, we are proud to be able to present this innovative product to you.

It's brought to you by all the highly-qualified personnel here at RADEMACHER.



i	Dear Customer,	2
1.	This manual... ..	6
1.1	How to use this manual	6
2.	Hazard symbols	7
2.1	Levels of danger and signal words.....	7
2.2	Symbols and depictions used.....	8
2.3	Glossary - definition	9
3.	Included in delivery	11
4.	General view of the operating unit.....	12
4.1	General view of the installation housing.....	14
4.2	Electrical connections.....	15
4.3	Display and its symbols.....	16
4.4	Views of the standard display	18
5.	Product description	20
5.1	Overview of functions	23
5.2	Functions and sample applications.....	24
6.	Technical specifications	30
6.1	Factory settings.....	33
6.2	Conduct in the event of a power failure	34
7.	Safety instructions	35
7.1	Intended use	36
7.2	Improper use.....	37
7.3	Required expert knowledge of the installer.....	37
8.	Safety instructions for the electrical connection	38
8.1	Important information prior to the electrical connection and installation.....	40
8.2	Electrical connection.....	42
8.3	Connection diagram with a 230 V control valve	43
8.4	Connection diagram with a 24 V control valve.....	44

9.	Installation after the electrical connection	45
10.	Introduction to opening the menus and setting the functions	46
11.	Initial commissioning with the help of the installation wizard.....	48
12.	Manually changing the target temperature	52
13.	Switching automatic mode on/off directly on the standard display	53
14.	Calling up and displaying weather data	54
15.	Menu overview	56
15.1	Menu 1 - Switching automatic mode on/off	58
15.2	Menu 2 - Setting automatic heating phases	59
15.3	Menu 3 - Setting target temperatures centrally.....	74
16.	Menu 9 - System settings.....	76
16.1	Menu 9.1 - Setting the time and date	77
16.2	Menu 9.5 - Setting the week programme.....	78
16.3	Menu 9.7 - Installer settings	80
16.4	Menu 9.7.1 - Setting the heating mode	81
16.5	Menu 9.7.2 - Setting the sensor offset	85
16.6	Menu 9.7.3 - Setting the hysteresis / minimum on-time	86
16.7	Menu 9.7.4 - Setting the valve protection	87
16.8	Menu 9.7.5 - Setting the frost protection	88
16.9	Menu 9.7.6 - Setting the valve mode	89
16.10	Menu 9.7.7 - Performing a sensor test.....	91

17. Menu 9.8 - Device settings	92
17.1 Menu 9.8.1 - Switching the automatic summer/ winter time on/off.....	93
17.2 Menu 9.8.3 - Setting the display lighting.....	94
17.3 Menu 9.8.5 - Switching the button lock on/off.....	95
17.4 Menu 9.8.6 - Setting the holiday mode incl. the setback temperature	97
17.5 Menu 9.8.7 - Setting the party mode incl. the comfort temperature	99
17.6 Menu 9.8.0 - Displaying the software version.....	101
18. Menu 9.9 - DuoFern settings.....	102
18.1 Menu 9.9.1 - Logging DuoFern devices on/off	103
18.2 Menu 9.9.2 - Setting the DuoFern mode	107
18.3 Menu 9.9.3 - Setting the transmission channel.....	109
18.4 Menu 9.9.4 - Switching the weather data on/off	110
18.5 Menu 9.9.5 - Displaying the DuoFern address (radio code).....	112
19. Logging on to the HomePilot®	113
19.1 Available actuator settings	115
19.2 Available sensor settings.....	116
19.3 Sample automation of a temperature dependent skylight control	117
20. Deleting all settings, software reset	120
21. Carrying out a hardware reset	121
22. Error messages.....	122
23. Dismantling	125
24. Simplified EU Declaration of Conformity.....	126
25. Accessories	126
26. Warranty conditions	127



1. This manual...

EN

...describes how to install, connect and operate the DuoFern Room Thermostat 9485.



1.1 How to use this manual

- ◆ Before you begin, please read this manual through completely and follow all the safety instructions
- ◆ Please also read the instruction manuals of the accessories (if available) as well as the instructions of the respective connected electrical appliance
- ◆ This manual is part of the product. Please store it in an easily accessible place
- ◆ When passing the DuoFern Room Thermostat 9485 on to a third party, this manual must be passed on as well
- ◆ Damage resulting from non-compliance with these instructions and safety instructions will void the warranty. We assume no liability for any consequential damage.



2. Hazard symbols

The following hazard symbols are used in this instruction manual:



Danger of fatal electric shock



Danger area / dangerous situation



2.1 Levels of danger and signal words

 **DANGER!**

This hazard will lead to serious injury or death if not avoided.

 **WARNING!**



This hazard may result in serious injury or death if not avoided.

 **CAUTION!**

This hazard may result in minor or moderate injury if not avoided.

 **ATTENTION!**

This hazard may lead to property damage.

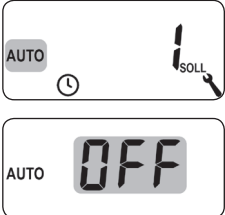
Depiction	Description
1.	Procedures
2.	
◆	Itemisation
1) or a)	Lists
	Further useful information
	Please read the respective manual
	Flashing menu symbols and setting parameters have a grey background. Information about opening the menus and setting the parameters can be found on page 46.

UW

- ◆ UW = ultra-white (device colour)

DIN 49075

- ◆ German Standard "Cover panels for installation devices for building into device boxes..."

2014/53/EU

- ◆ European Radio Equipment Directive

ELV

- ◆ Extra low voltage

Electrothermal control valves

Electrothermal valves with the switching states "**normally closed (NC) or normally open (NO)**" are often used for heating control.

You can set the respective valve mode on the DuoFern Room Thermostat 9485 to adapt to the control valve used in each case.

Valve mode NC (normally closed)

- ◆ The control valve remains closed in an isolated, de-energised state

Valve mode NO (normally open)

- ◆ The control valve remains open in an isolated, de-energised state

Hysteresis / minimum on-time

- ◆ This function prevents an unnecessary large number of switching operations by setting a minimum on-time
- ◆ This prevents the DuoFern Room Thermostat 9485 tripping too often if the room temperatures fluctuate

Offset (sensor offset)

- ◆ The temperature measured on site can vary slightly from the room temperature if the DuoFern Room Thermostat 9485 is installed in a unfavourable position (e.g. behind a curtain or on a cool exterior wall)
- ◆ An adjustment of the measurement in the range of - 5.0°C to + 5.0 °C can be carried out using the sensor offset

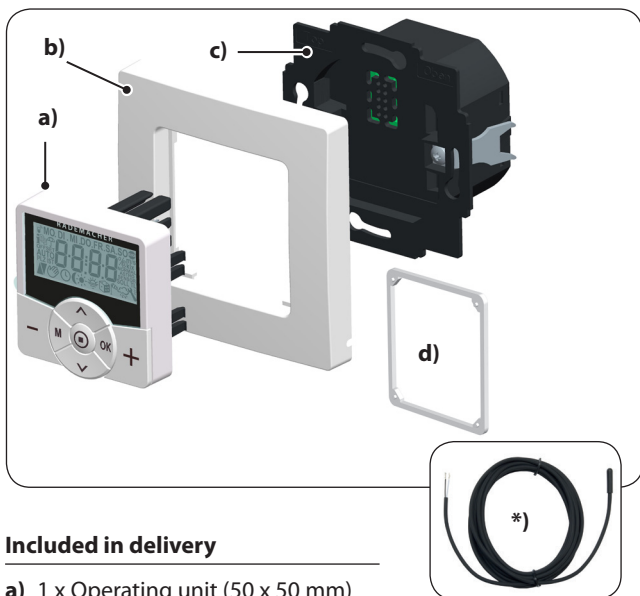

Included in delivery

- a) 1 x Operating unit (50 x 50 mm)
- b) 1 x Frame
- c) 1 x Installation housing
- d) 1 x Spacer frame, see page 45
- e) 1 x Instruction manual (not illustrated)



After unpacking please check and compare...



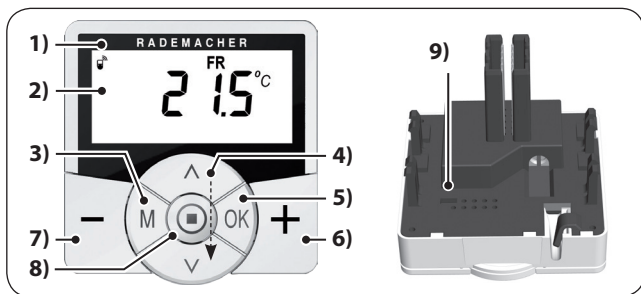

... the contents of the package with those specified above.

***) Accessories optionally available, see page 126**

Remote Sensor 9485-F



Pos.	Symbol	Description
1)		Operating unit
2)		Display
3)		Menu button <ul style="list-style-type: none"> ◆ Open the main menu ◆ Back to the previous menu or standard display
4)	 	Setting buttons <ul style="list-style-type: none"> ◆ Select a menu in the main menu ◆ Set the parameters (more / less) <ul style="list-style-type: none"> ● Short press or press and hold = gradual or quick setting ◆ Switch functions on / off (On / OFF) ◆ Select the display (target (SOLL) / actual (IST) temperature / time)

Pos.	Symbol	Description
5)		OK button <ul style="list-style-type: none">◆ <i>Open the selected menu</i>◆ <i>Confirm and save settings</i>◆ <i>Continue to the next setting</i>
6)		Plus button - HOTTER <ul style="list-style-type: none">◆ <i>Gradually increase the target temperature by 0.5 °C</i>
7)		Minus button - COLDER <ul style="list-style-type: none">◆ <i>Gradually reduce the target temperature by 0.5 °C</i>
8)		SET button <ul style="list-style-type: none">◆ <i>Switch the button lock on/off (only when the button lock function is activated)</i>◆ <i>Display weather information</i>
9)		Bridging contact for a hardware reset <ul style="list-style-type: none">◆ <i>See page 121</i>

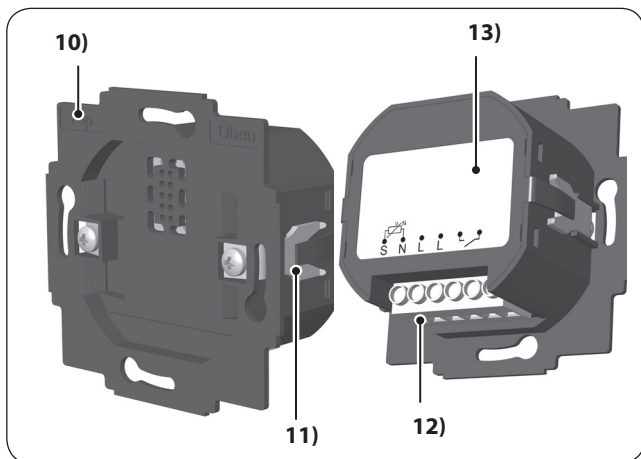

Pos.	Symbol	Description
10)		Installation housing
11)		Claw fasteners and screws
12)		Connecting terminals
13)		Type plate

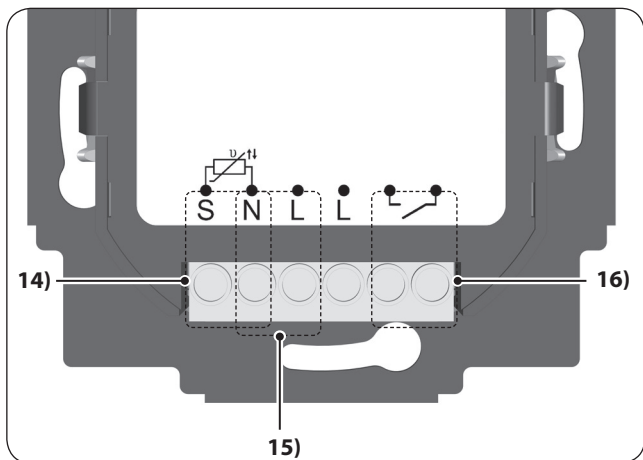







Pos.	Symbol	Description
------	--------	-------------







14)		Remote Sensor 9485-F [S / N] - optional Connect the external Remote Sensor 9485-F to measure the room temperature.
-----	--	--

15)		Supply voltage [N / L] - 230 V / 50 Hz \sim Connect the supply voltage.
-----	--	---

16)		Relay output - potential-free Connect an electrothermal control valve (also with extra-low voltage) / electric heater or the air conditioning.
-----	--	--



Pos.	Symbol	Description
17)	MO... SO	Weekdays (Monday...Sunday)
18)	00:00	Time / setting parameters
19)		DuoFern status
20)		Weather information
21)		Week programme
22)		Rain display
23)	OFFSET	Sensor offset
24)	AUTO	Automatic mode
25)		Automatic mode off or manually changed target temperature
26)		Heating

Pos.	Symbol	Description
27)		Cooling
28)		Switching times for the heating phases
29)		Brightness display
30)		Dusk display
31)		Wind display
32)		System settings
33)	SOLL	Target temperature
34)	SENSOR	Sensor test
35)	klx / lx	Light intensity (klx = Kilolux / lx = Lux)
36)	°C	Temperature unit in degrees Celsius
37)	m / s	Wind velocity (meters per second)
38)		Automatic button lock



The DuoFern Room Thermostat 9485 has adjustable LCD backlighting, see page 94, menu 9.8.3.



You can select the desired view of the standard display using the set buttons.

Target temperature

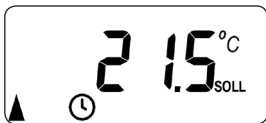

Symbols	Description
21.5 °C SOLL	The set target temperature

Actual temperature



Symbols	Description
19.8 °C	The current room temperature

Time









Symbols	Description
FR	The current weekday
16:30	The current time



Other symbols can be displayed depending on the setting of the DuoFern Room Thermostat 9485.

Examples:

Symbols	Description
	Automatic mode is active. Heating or cooling is provided at the set switching times until the room temperature reaches the target value.
	The target temperature has been manually changed.
	Heating is provided as the current room temperature is lower than the target temperature.
	Cooling is provided as the current room temperature is higher than the target temperature.
	The current weather information from a DuoFern Environmental Sensor is available.
	Wind or rain display
	Brightness or dusk display

The DuoFern Room Thermostat 9485 automatically measures and controls the room temperature in individual rooms, e.g. by controlling a radiator, the floor heating or air conditioning. The temperature is either measured by the built-in sensor or by the optional external Remote Sensor 9485-F. The room thermostat has a potential-free relay output.

Support for three heating modes

The DuoFern Room Thermostat 9485 can be used and configured in three different heating modes, see page 81:

- ◆ Room temperature controller
- ◆ Room temperature controller with limiter function
- ◆ Cooling function

Setting multiple heating phases

Up to six heating or cooling phases (incl. four target temperatures) can be set for each day.

Setting heating phases centrally in the HomePilot® or locally in the DuoFern Room Thermostat 9485

The desired use is carried out by selecting the corresponding DuoFern mode in menu 9.9.2, see page 107.

Potential-free relay output

The following electrical appliances, for example, can be connected to the potential-free relay output:

- ◆ Control valves (also extra-low voltage valves)
- ◆ Heaters (also electrical heaters up to max. 2300 W)
- ◆ Air conditioning

Connecting an external temperature sensor (optional)

The Remote Sensor 9485-F is optionally available as an external temperature sensor if the internal sensor cannot reliably record the room temperature. This may be useful if:

- ◆ The DuoFern Room Thermostat 9485 is installed in a thermally unfavourable position (e.g. on a cool exterior wall)
- ◆ Heavy loads (e.g. an electric heater) are switched on that significantly heat up the DuoFern Room Thermostat 9485 (self-heating)

When is it absolutely essential to use the external Remote Sensor 9485-F?

- ◆ If you are using the DuoFern Room Thermostat 9485 as a temperature limiter (e.g. for floor heating with special floor coverings).

Two valve modes (NC/NO) to adapt to the control valve used

Electrothermal valves with the switching states "**normally closed (NC)**" or "**normally open (NO)**" are often used for heating control.

You can set the respective valve mode in menu 9.7.6 to adapt to the control valve used in each case, see page 89.

Manual mode

The device is manually operated with the plus and minus button.

These buttons can be used to gradually increase or decrease the target temperature by 0.5 °C, see page 52.

Installation and electrical connection

The DuoFern Room Thermostat 9485 is designed as a flush-mounted device for indoor rooms. The electrical connection is carried out by means of the connecting terminals on the reverse side of the installation housing.

Compatible switch ranges

The DuoFern Room Thermostat 9485 can be integrated into standard switch range (50 x 50 mm).



It may be necessary to use an intermediate frame * 50 x 50 (according to DIN 49075) depending on the switch range used.

** Not included*

- ◆ For use as a local control on site or as a system solution (HomePilot® / DuoFern radio system)
- ◆ Manual operation on site with the plus and minus buttons
- ◆ AUTO / MANUAL switchover
- ◆ Easy set-up thanks to the installation wizard
- ◆ Heating and cooling function depending on the connected device
- ◆ Configurable for up to 6 switching times per day and any 4 target temperatures
- ◆ Optional external temperature sensor (Remote Sensor 9485-F) can be used for external temperature measurement or as a temperature limiter
- ◆ Control of the valve / radiator or air conditioning in combination with a DuoFern actuator also by radio (ideal for retrofitting)
- ◆ Two-step control (on/off) with configurable hysteresis and adjustable minimum switching time
- ◆ Target temperature can also be manually changed by the manual transmitter
- ◆ Receipt and display of weather data (temperature, brightness, wind velocity and rain) in combination with a DuoFern Environmental Sensor
- ◆ Three different week programmes
- ◆ Automatic button lock
- ◆ Dimming of the LCD backlighting
- ◆ Sensor test
- ◆ Delete or reset all data

Sample application 1

DuoFern Room Thermostat 9485 for individual room regulation of radiators, floor heating or the air conditioning.

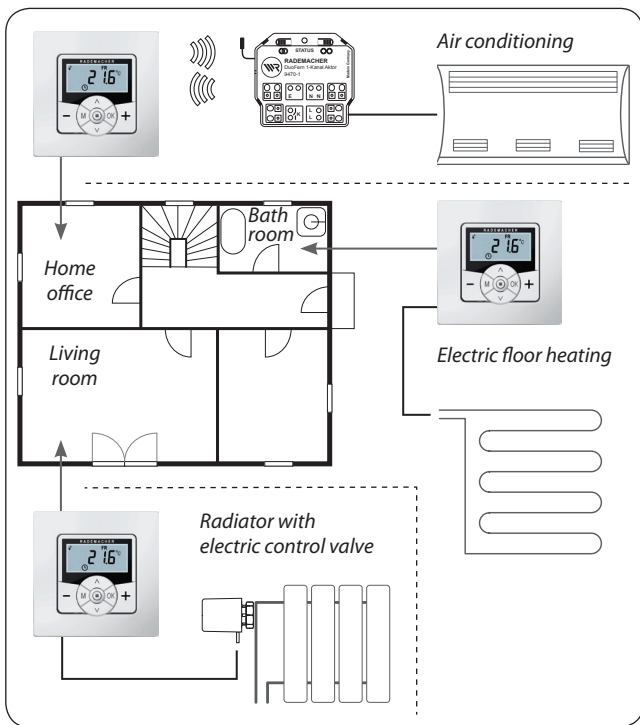

Home office

Control the air conditioning by radio using a DuoFern Universal actuator (e.g. for retrofitting without cabling between the DuoFern Room Thermostat 9485 and the air conditioning).

Bathroom

Directly connect and control electric floor heating.

Living room

Directly connect an electrothermal control valve to control a radiator.

Sample application 2

Several DuoFern Room Thermostats 9485 for individual room regulation of floor heating using DuoFern actuators.

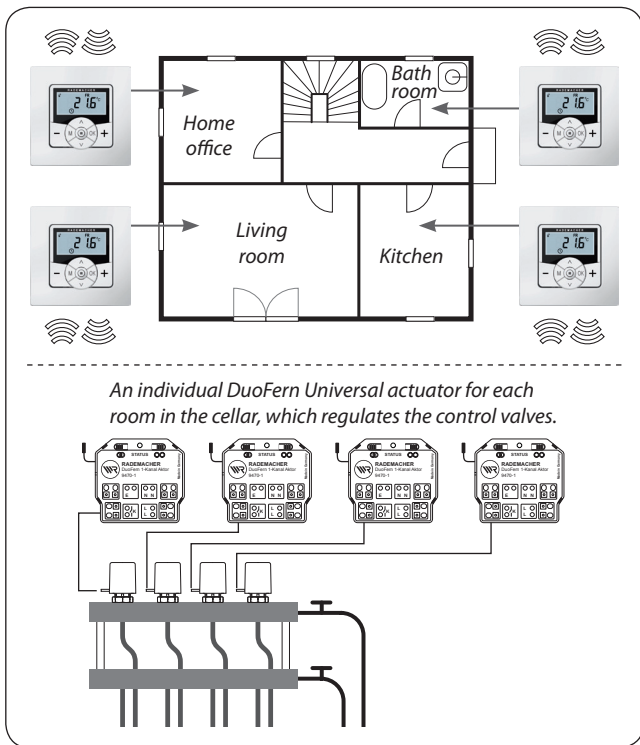

A DuoFern Universal actuator (1-channel) per room in the cellar:

- ◆ This receives the switching commands directly from the respective DuoFern Room Thermostat 9485, thus regulating the control valves (e.g. for retrofitting if no leads to the heating manifold are present.)
- ◆ The parallel connection of several control valves from one room to one 1-channel Universal actuator each is possible



There is a risk of an unintentional or erroneous influence through automated scenes or manual operation.

- ◆ A DuoFern actuator logged on to the DuoFern Room Thermostat 9485 must not be logged on to the HomePilot® or to other DuoFern controllers (e.g. DuoFern manual transmitters).

Sample application 3

Central control through the HomePilot®

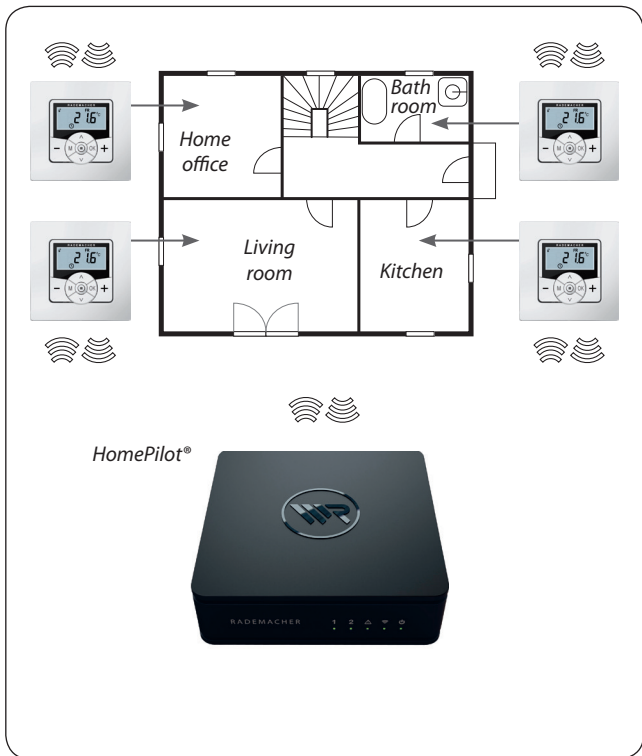

The DuoFern Room Thermostat 9485 can be connected to the HomePilot®. This means that the following functions can be used:

- ◆ The target temperature and display of the current state (actual temperature, target temperature etc.) can be changed manually with smartphone apps
- ◆ The four saved target temperatures can be changed at any time via the HomePilot® web interface
- ◆ Scenes can be triggered in the HomePilot® if the temperature drops below or exceeds the four saved target temperature values
- ◆ The DuoFern Room Thermostat 9485 must be operated in mode 1 (DuoFern receiver) to control the heating phases through scenes in the HomePilot®



Direct access from the HomePilot® to the relay switching state is not possible.

- ◆ The switching of the relay is always dependent on the target and actual temperature.

Mains supply [L / N]





Mains supply voltage:	230 V / 50 Hz 
Consumption:	Standby: < 0.4 W

Sensor input [S / N] -

e.g. to connect the Remote Sensor 9485-F

Requirement:	double insulated
R25:	10 k Ω
B:	3977

Relay output - load contact for 230 V []

Switching voltage:	230 V / 50 Hz 	
Maximum switching capacity:	ohmic load	
		10 A μ / 2300 W
	inductive loads:	
	 	5 A μ / 1115 VA
		

Relay output - load contact for 230 V []

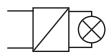
Maximum switching capacity:	capacitive loads	
		5 A μ / 1115 VA





Improper use can lead to serious injuries or property damage.

- ◆ Due to the small contact distance (μ), not suitable for disconnecting.
- ◆ Do not use the DuoFern Room Thermostat 9485 to disconnect the connected electrical appliance.

DuoFern radio technology

Transmission frequency:	434.5 MHz
Transmission power:	max. 10 mW
Range:	in buildings: approx. 30 m * outdoors: approx. 100 m * <i>depending on the building structure</i>
Max. number of DuoFern devices:	20

General information	
External dimensions (W x H x D) Operating unit [1]:	50 x 50 x 12 mm according to DIN 49075
Available colours:	ultra-white (UW), glossy
Installation depth:	32 mm
Permissible ambient temperature range:	0 °C to + 40 °C
Protection class:	II
Protection type:	IP 30 (<i>only for use in dry rooms</i>)
Connecting terminals:	Screw terminals for max. 1.5 mm ² cable cross-section
Power reserve for clock in the event of a power failure	approx. 8 hours

Factory settings	
Automatic mode:	off
Automatic time:	off
Hot (21.5 °C) from:	06:00
Cold (17.0 °C) from:	23:00
Target temp. 1 and 3:	21.5 °C
Target temp. 2 and 4:	17.0 °C
Weekly programme:	off
Automatic summer/winter changeover:	on
Standard display:	target temperature
Heating mode:	1 (room temperature controller)
Hysteresis:	0.2 °C
Min. on-time / off-time:	2 minutes
Valve protection:	off
Frost protection:	on; 4.0°C
Valve mode:	NC (energised heating)
Quick changeover to temperature value:	
- with  (hot):	off
- with  (cold):	off
DuoFern transmission channel:	channel 1

Power reserve (approx. 8 hours)

The current time flashes for approx. 5 minutes in the event of a power failure and the DuoFern room thermostat changes to power reserve.

Time and date after a power failure

The power reserve is approx. 8 hours. If this time is exceeded, the time and date are lost and need to be reset, see page 77.



The internal timer works with tolerances in power reserve mode. It may therefore be necessary to adjust the time after a longer power failure.

Data retention following a power failure

All settings remain permanently saved. Data is not lost even after a longer power failure.



The use of defective equipment can lead to personal injury and damage to property (electric shocks / short circuiting).

- ◆ Never use defective or damaged equipment.
- ◆ Check that the DuoFern Room Thermostat 9485 is intact.
- ◆ Consult our customer service department in the event that you discover damage, see page 128.



Improper use leads to an increased risk of injury.

- ◆ Train all personnel to use the DuoFern Room Thermostat 9485 safely.
- ◆ Children must not play with the device.
- ◆ Never remove the operating unit from the installation housing during operation.



Risk of damage due to the overheating or excessive cooling of the room or flooring.

The relay output remains unchanged if the operating unit is pulled out of the installation housing during operation. Control and limiting functions where appropriate are no longer provided.

- ◆ Make sure that a relay state that poses no risk is set before removing the operating unit.
- ◆ Switch off the central heating or air conditioning beforehand if necessary.

Use the DuoFern Room Thermostat 9485 solely to control radiators / floor heating or the air conditioning within the permissible load limits, see page 30, Technical specifications.

The DuoFern Room Thermostat 9485 is suitable for switching the mains voltage and extra-low voltage (ELV) with basic insulation.

Only use original spare parts and accessories from RADEMACHER

- ◆ By doing so, you avoid the risk of malfunctions and damage to the DuoFern Room Thermostat 9485
- ◆ As the manufacturer, we provide no warranty for the use of third-party components and accept no liability for consequential damage resulting from such

Operating conditions

- ◆ Only use the DuoFern Room Thermostat 9485 in dry rooms
- ◆ A 230 V/50 Hz power supply, together with a site-provided disconnecting device (fuse), must be available at the installation location
- ◆ The installation and operation of the radio systems is only permitted for those systems and devices where a malfunction in the transmitter or receiver would not cause a danger to personnel or property or where this risk is already covered by other safety equipment



Radio systems that transmit on the same frequency can cause interference.

Using the DuoFern Room Thermostat 9485 for any other purpose than previously mentioned is not permissible.



Improper use can lead to serious injuries or property damage.

- ◆ Do not use the DuoFern Room Thermostat 9485 to disconnect the connected electrical appliance.
- ◆ Never use the radio system (e.g. DuoFern radio system) and its components for the remote control of devices and systems with increased safety-relevant requirements or where there is an increased risk of accidents. Such applications require additional safety equipment. Observe the respective statutory regulations for the installation of such systems.



There is a risk of fatal injury caused by short circuiting and electric shocks if the DuoFern Room Thermostat 9485 is used outdoors or in damp rooms.

- ◆ Do not install and use the DuoFern Room Thermostat 9485 outdoors or in damp rooms.

7.3 Required expert knowledge of the installer

The electrical connection, installation and commissioning of the DuoFern Room Thermostat 9485 must be carried out by a qualified electrician with basic heating control knowledge in accordance with the instructions in this manual.

i 8. Safety instructions for the electrical connection **EN**

Prior to the electrical connection, check that the voltage / frequency on the type plate corresponds to that of the local mains supply.



Read the specifications relating to the electrical connection detailed in the instruction manual of the electrical appliance used.

DANGER!

There is a risk of fatal electric shock when touching electrical components.

- ◆ All connection and installation work must only be carried out in a de-energised state.
- ◆ Disconnect all phases of the mains power cable and secure it to prevent any reconnection.
- ◆ Check that the system is de-energised.

WARNING!

There is a risk of fatal injury caused by short circuiting when the DuoFern Room Thermostat 9485 is overloaded.

The maximum switching capacity must not be exceeded, for this, please observe the details in the technical specifications, see page 30.

i 8. Safety instructions for the electrical connection **EN**



Using an incorrect installation housing can lead to personal injury and damage to property (electric shocks / short circuiting).

- ◆ Only use the installation housing provided to connect and install the DuoFern Room Thermostat 9485.
 - ◆ Installation housings of other RADEMACHER products are not compatible.
-



Incorrect wiring may lead to short circuits and destroy the device.

Follow the pin assignment detailed in the connection diagram.

Potential-free relay output

The relay is potential-free. Control valves and controllers that require a different supply voltage can also be connected (e.g. 24 V). One side of the relay contact should be set to the respective control voltage (e.g. +24 V) instead of [L] in this case, see page 44.

Only switch extra-low voltage with basic insulation

Only extra-low voltages (ELV) with basic insulation may be connected and switched.

Installation materials

The DuoFern Room Thermostat 9485 is intended for flush mounting. We recommend installation in a deep 58 mm flush-mounted box or in an electronic socket.

Length of insulation stripped:

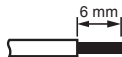

All leads must be stripped to 6 mm.

Optional connection of the external Remote Sensor 9485-F

The external Remote Sensor 9485-F can optionally be connected for temperature measurement if the DuoFern Room Thermostat 9485 is installed in a thermally unfavourable position.



Absolutely essential use of the external Remote Sensor 9485-F

It is absolutely essential that the Remote Sensor 9485 is connected when using limiting functions (heating mode 2 = room temperature controller with limiter).

Maximum length of lead to connect the external Remote Sensor 9485-F

The maximum length of lead to connect the external Remote Sensor 9485-F must not exceed 10 m.

- 1.** Ensure the mains is disconnected and check whether the mains power cables are current-free.

- 2.** Securely lay all connecting cables right into the flush-mounted box.

- 3.** Remove the insulation on all leads down to 6 mm in length and connect them according to the connection diagram on the following pages.

- 4.** After the electrical connection, the installation of the DuoFern Room Thermostat 9485 into the flush-mounted box is carried out, see page 45.



8.3 Connection diagram with a 230 V control valve **EN**

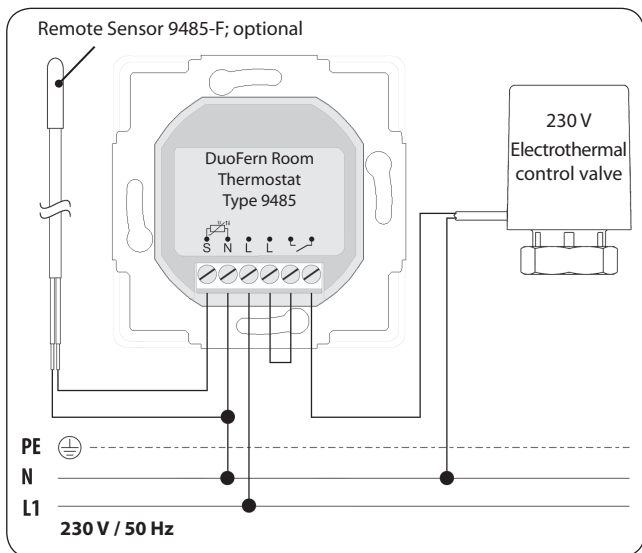



8.4 Connection diagram with a 24 V control valve

EN

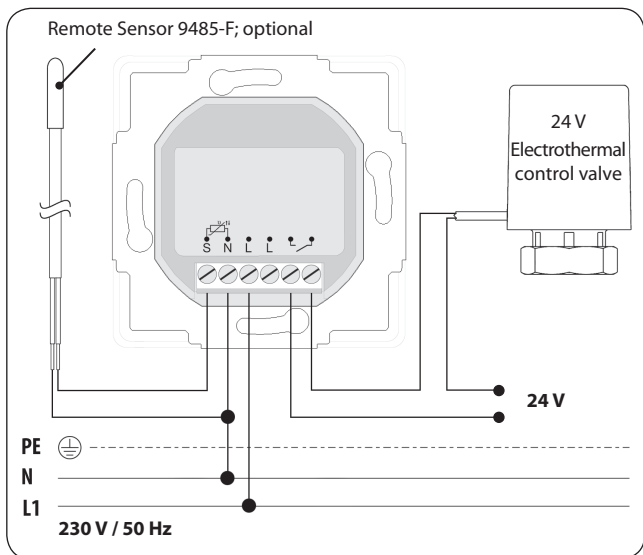

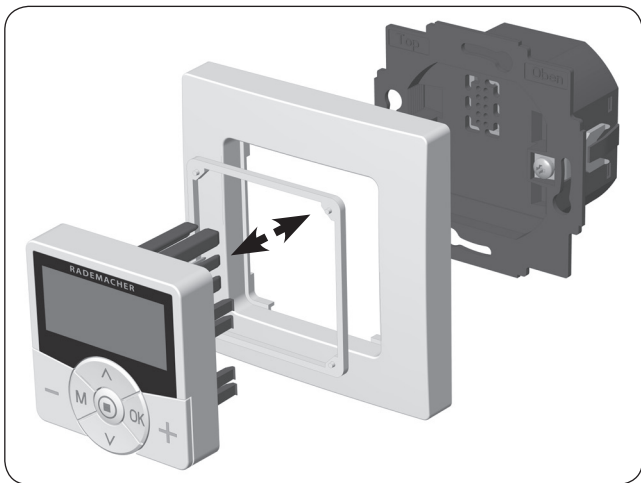

1. Insert the installation housing into the flush-mounted box and fasten it with the screws of the claw fasteners.
2. Place the frame on to the installation housing.
3. Place the spacer frame in the frame.
4. Then carefully insert the operating unit into the installation housing .
5. Switch on the mains power supply again.

1. **M** Open the main menu.

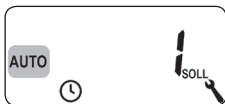

Pressing the menu button in the standard display opens the main menu.

2. **^** / **v** Select the desired menu.

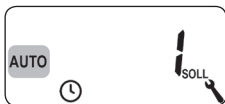

The selected menu is indicated by a flashing symbol.

3. **OK** Confirm and open the selected menu.





OFF flashes.



10. Introduction to opening the menus and setting the functions

EN

4.  /  Select the desired setting (e.g. On).



5.  Each setting must be confirmed with the OK button.

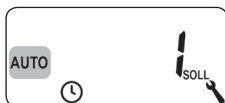

Confirming the entry takes you to the next setting or back to the menu.

6.  Back to the standard display.



Example



Pressing the menu button briefly takes you back one menu step. Pressing and holding the button always take you to the standard display.

The installation wizard, which guides you through the first basic settings, is automatically started for the initial commissioning or after a software reset.

Continue with menu 9.7 "Installer settings"

The settings in menu 9.7 must be checked and adapted to the existing heating installation after completing the installation wizard, see page 80.

Readiness for operation

The DuoFern Room Thermostat 9485 is ready for operation after completing the settings mentioned above.

1. The installation wizard is shown after switching on the mains voltage. The digits start flashing.

2. Set and confirm the current time.



3. Set the current date (day, month), and confirm each setting.



4. Set and confirm the current year.



5. Set and confirm the starting time of the first heating phase.



Factory setting = 06:00

Maximum number of daily heating phases

A maximum of six heating phases can be set up for each day, see page 59, menu 2.

Pre-setting the week programme

The first starting time applies to the entire week (**MO...SO**).

If necessary, you can then select one of three week programmes in menu 9.5, see page 78.

Assigning different target temperatures

Each heating phase can be assigned an individual target temperature. You can set four target temperatures and assign any number of heating phases, see page 59, menu 2.

6.  Select and confirm the number of the desired target temperature for this heating phase.

7.  Set and confirm the desired target temperature.

Factory setting = 1·21.5 °C

8.  Set and confirm the starting time of the second heating phase.

Factory setting = 23:00

9.  Select and confirm the number of the desired target temperature for this heating phase.

10.  Set and confirm the desired target temperature.

Factory setting = 2·17.0 °C

i 11. Initial commissioning with the help of the installation wizard

11.

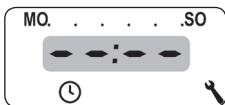

Set the starting time of the next heating phase (see points 8 to 10.).

or

Exit the settings in the installation wizard by selecting and confirming



12.

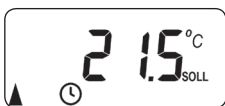

The standard display is shown after the final setting.

Example

13. The settings in menu 9.7 must be checked and adapted to the local heating installation after completing the installation wizard, see page 80.



12. Manually changing the target temperature

EN

If necessary you can manually change the target temperatures of the automatic heating phases temporarily. The change is made on the standard display.

➤  **(Hotter)** Gradually increase the target temperature by 0.5 °C.

➤  **(Colder)** Gradually reduce the target temperature by 0.5 °C.

Display example:



The target temperature has been manually changed.



The manual change only applies until the next automatic heating phase becomes active at the set switching time.

Resetting the manual change

 1 sec. Press the OK button on the standard display for one second to reset the manual change. The automatic mode with its set heating phases and target temperatures then applies again.



Automatic mode on

- ◆ All previously set automatic functions are active.
- ◆ Manual operation is also possible in automatic mode.



Automatic mode off

- ◆ All set automatic functions are deactivated.

1.  1 sec.

Press the OK button for one second on the standard display.



Automatic mode on



Automatic mode off



If the target temperature was previously changed, you have only reset the manual change of the target temperature in the first step.

- ◆ Press the OK button again in this case to switch off automatic mode.

The DuoFern Room Thermostat 9485 can receive and display weather data (temperature, brightness, wind velocity and rain) from a DuoFern Environmental Sensor. It is not necessary to log the DuoFern Environmental Sensor on to the DuoFern Room Thermostat 9485.



Environmental sensors update the weather data approx. every 5 minutes and therefore it can take a few minutes until the weather data is displayed.

- ◆ If no new weather data is received for 45 minutes, this is no longer available.



In the event that multiple DuoFern Environmental Sensors are being received, the desired environmental sensor can be selected in menu 9.9.4, see page 110.

1. As soon as an environmental sensor is detected, the corresponding symbol is shown on the display.



- 2.

Pressing the SET button briefly displays the first weather data.

3.  / 

You can call up all the available weather data using the set buttons, see examples.

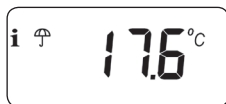

Temperature and rain



Brightness
0 - 999 Lux = lx
1 - 150 kilo lux = klx

Symbol depending on the brightness:

< 50 lx =  (dusk)

> 50 lx = 



Wind velocity
0 - 35 m/s

Exiting the weather data display





4. 





Pressing the SET button briefly exits the weather data display.



The display automatically switches to the standard display after 10 seconds.

Main menu

Symbol	Menu	Page
AUTO	1 Automatic mode	58
	2 Switching times / automatic heating phases	59
SOLL	3 Target temperatures / numbers	74
	9 System settings	76
SET	9.1 Time and date	77
	9.5 Week programme	78
	9.7 Installer settings	80
	9.7.1 Heating mode.....	81
OFFSET	9.7.2 Sensor offset	85
H	9.7.3 Hysteresis and minimum on-time	86
	9.7.4 Valve protection	87
	9.7.5 Frost protection	88
	9.7.6 Valve mode	89
SENSOR	9.7.7 Sensor test	91

	9.8	Device settings	92
	9.8.1	Automatic summer / winter changeover.....	93
	9.8.3	Display lighting	94
	9.8.5	Button lock	95
▼	9.8.6	Holiday mode	97
▲	9.8.7	Party mode	99
	9.8.0	Software version	101
	9.9	DuoFern settings	102
	9.9.1	Logging on and off.....	103
	9.9.2	Setting the DuoFern mode	107
Ch	9.9.3	Setting the transmission channel	109
 	9.9.4	Switching the weather data on/off	110
 IST	9.9.5	Displaying the DuoFern address (radio code)	112



Standardised menu structure

A standardised, cross-product menu structure has been developed for all RADEMACHER devices. Similar functions always have the same menu number and therefore there may be gaps in the numbering.

 **Automatic mode on (symbol on the standard display)**

- ◆ All set automatic functions are active
- ◆ Manual operation is also possible in automatic mode

 **Automatic mode off (symbol on the standard display)**

- ◆ All automatic functions are deactivated

 **Both symbols on the standard display**

-  ◆ Automatic mode on and the target temperature has been manually changed - the change applies to the next heating phase

Switching automatic mode on/off in menu 1

1. Open menu 1.

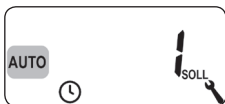

2. Select and confirm the desired setting.



- OFF = Automatic mode off**
On = Automatic mode on

Toggleing directly on the standard display

-  1 sec. Press the OK button for one second on the standard display.



You can set automatic heating phases for each day with the desired switching time and target temperature.

Maximum number of daily heating phases

A maximum of six heating phases can be set up for each day.

Pre-setting the week programme

First select the desired week programme in menu 9.5, see page 78.

Additional information about the setting:

- ◆ The switching times of the heating phases are set in 15 minute steps (e.g. 06:00, 06:15, 06:30 etc.)
- ◆ A new heating phase cannot be set before the previous heating phase
- ◆ Four adjustable target temperatures are stored. These can be randomly assigned to the individual heating phases
- ◆ If the setting of a heating phase sequence should be terminated, select and confirm the next switching time with:
- ◆  The setting of the heating phases can also be terminated by pressing and holding the SET button



We show you three examples below for the setting of automatic heating phases:

Example 1**Family programme**

The automatic heating phases should apply for the entire week (Mon - Sun) **[MO - SO]**.

Example 2**Single household**

The automatic heating phases should be set separately for the weekdays (Mon - Fri) **[MO - FR]** and the weekend (Sat - Sun) **[SA - SO]**.

Example 3**Home office**

Heating should only be provided on Friday and Saturday.



Example 1 Setting (family programme)

The room temperature is regulated to the desired target temperature or setback temperature at the same switching times on all weekdays.

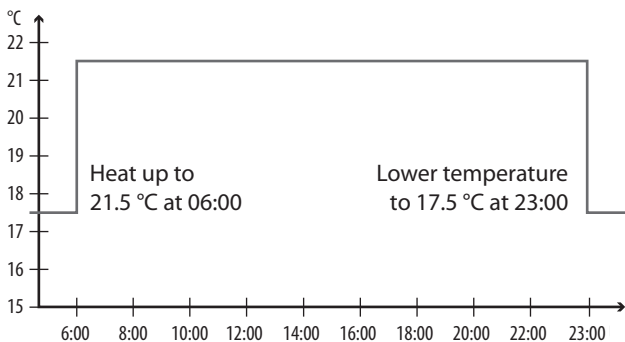

MO.SO (Monday.Sunday)			
Heating phase	Time	Target temperature (SOLL)	
		No.	°C
1	06:00	1	21.5 °C
2	23:00	2	17.5 °C
3	● ● ● ●		



15.2 Menu 2 - Setting automatic heating phases

EN

1. First open menu **9.5** and set the week programme [**1**].



2. Then menu **2** opens automatically

or

Open menu **2** if the desired week programme is already active.



3. Set and confirm the starting time of the first heating phase.



e.g. 06:00

4. Select and confirm the number of the desired target temperature for this heating phase, **e.g. 1**.



5. Set and confirm the desired target temperature.



e.g. 21.5 °C



15.2 Menu 2 - Setting automatic heating phases

EN

6.



Set and confirm the starting time of the second heating phase.

e.g. 23:00

7.



Select and confirm the number of the desired target temperature for this heating phase, **e.g. 2**.

8.



Set and confirm the desired target temperature (e.g. setback temperature).

e.g. 17.0 °C

9.

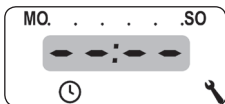

Terminate and confirm the setting of the heating phases.

10.



Subsequently the main menu is displayed

or



Menu **9.5**.



Example 2 Setting (single household)

The room temperature should be regulated to different temperatures at different times on weekdays and at the weekend.

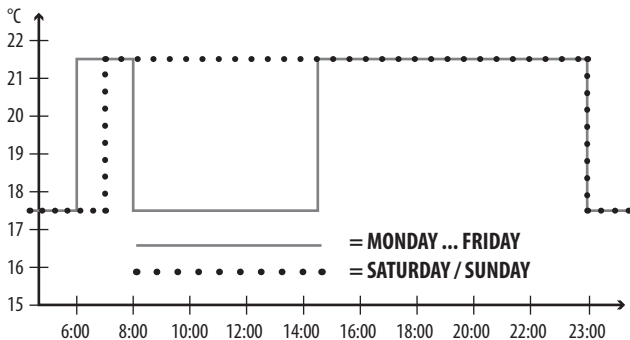

MO. . . . FR (Monday Friday)			
Heating phase	Time	Target temperature (SOLL)	
		No.	°C
1	06:00	1	21.5 °C
2	08:00	2	17.5 °C
3	14:30	1	21.5 °C
4	23:00	2	17.5 °C
5	◀ ◀ : ▶ ▶		



15.2 Menu 2 - Setting automatic heating phases

EN

SA SO (Saturday / Sunday)			
Heating phase	Time	Target temperature (SOLL)	
		No.	°C
1	07:00	1	21.5 °C
2	23:00	2	17.5 °C
3	— — : — —		

1. First open menu **9.5** and set the week programme [**2**].



2. Then menu **2** opens automatically

or

Open menu **2** if the desired week programme is already active.





15.2 Menu 2 - Setting automatic heating phases

EN

3.



Set and confirm the starting time of the first heating phase.

e.g. 06:00

4.



Select and confirm the number of the desired target temperature for this heating phase, **e.g. 1**.

5.



Set and confirm the desired target temperature.

e.g. 21.5 °C

6.



Set and confirm the starting time of the second heating phase.

e.g. 08:00

7.



Select and confirm the number of the desired target temperature for this heating phase, **e.g. 2**.

8.



Set and confirm the desired target temperature (e.g. setback temperature).

e.g. 17.0 °C



15.2 Menu 2 - Setting automatic heating phases

EN

9.



Set and confirm the starting time of the third heating phase.

e.g. 14:30

10.



Select and confirm the number of the desired target temperature for this heating phase, **e.g. 1.** *

11.



Set and confirm the starting time of the fourth heating phase.

e.g. 23:00

12.



Select and confirm the number of the desired target temperature for this heating phase, **e.g. 2.** *



* The selected target temperatures cannot be changed because they are already used as they are already elsewhere in a heating phase.

13.

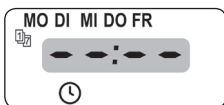

Terminate and confirm the setting of the heating phases for the weekdays Monday - Friday (**MO - FR**).

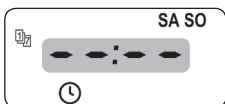

Setting the heating phases for Saturday / Sunday (SA/SO)

14.

Set and confirm the starting time of the first heating phase for the weekend.

e.g. 07:00

**15.**

Select and confirm the number of the desired target temperature for this heating phase, e.g. 1. *

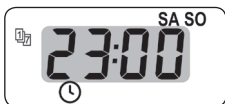
16.

Set and confirm the starting time of the second heating phase for the weekend.

e.g. 23:00

17.

Select and confirm the number of the desired target temperature for this heating phase, **e.g. 2.** *



* The selected target temperatures cannot be changed because they are already used as they are already elsewhere in a heating phase.



15.2 Menu 2 - Setting automatic heating phases

EN

18.

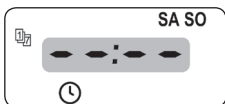

Terminate and confirm the settings for the weekend Saturday/Sunday (**SA / SO**).

19.



Subsequently the main menu is displayed

or



Menu **9.5**.



15.2 Menu 2 - Setting automatic heating phases

EN

Example 3 Setting (home office)

Heating should only be provided on Friday and Saturday.
The room temperature should be regulated to the setback temperature on all other days.

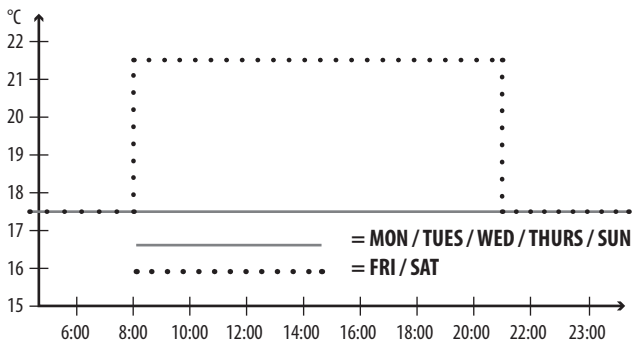

MO / DI / MI / DO + SO (Mo / Tues / Wed / Thurs + Sun)

Heating phase	Time	Target temperature (SOLL)	
		No.	°C
1	— — — —		

FR + SA (Friday + Saturday)

1	08:00	1	21.5 °C
2	21:00	2	17.5 °C
3	— — — —		



15.2 Menu 2 - Setting automatic heating phases

EN

1. First open menu **9.5** and set the week programme [**3**].



2. Then menu **2** opens automatically

or

Open menu **2** if the desired week programme is already active.



- 3.

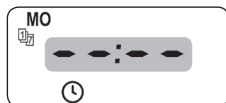

Select and confirm because heating should not be provided on Monday.

4. Repeat point 3 for Tuesday, Wednesday and Thursday.

- 5.



Set and confirm the starting time of the first heating phase for Friday.

e.g. 08:00



15.2 Menu 2 - Setting automatic heating phases

EN

6.



Select and confirm the number of the desired target temperature for this heating phase, **e.g. 1**.

7.



Set and confirm the desired target temperature.
e.g. 21.5 °C

8.

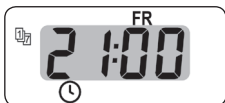

Set and confirm the starting time of the second heating phase for Friday.
e.g. 21:00

9.



Select and confirm the number of the desired target temperature for this heating phase, **e.g. 2**.

10.



Set and confirm the desired target temperature.
e.g. 17.0 °C

11.



Repeat points 5 to 10.
for Saturday. *

* If the same target temperatures are selected for this, they can no longer be changed.



15.2 Menu 2 - Setting automatic heating phases

EN

12.

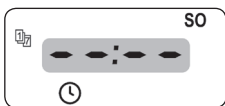

Select and confirm because heating should not be provided on Sunday.

13.



Subsequently the main menu is displayed

or

Menu **9.5**.



Target temperatures are configured and assigned in the installation wizard and in menu 2 "Setting automatic heating phases".



If the same target temperatures are used in different heating phases, they can only be changed centrally in menu 3.

Information about setting the target temperatures

- ◆ Four target temperatures are available that can be set centrally
- ◆ Each target temperature can be randomly used, e.g. as a comfort or setback temperature.
- ◆ Central changes to a target temperature affect all automatic heating phases that use this target temperature
- ◆ The target temperatures can also be changed with the HomePilot® through the advanced settings of the actuator

Setting target temperatures centrally

1. Open menu 3.

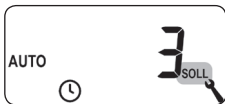

2.  Select and confirm the number of the target temperature to be changed.

3.  Change and confirm the target temperature.
Setting range = 4.0 °C to 40 °C



4. Repeat points 1 to 3 if you want to change other target temperatures.



This menu enables you to configure additional devices and system settings to customise the DuoFern Room Thermostat 9485 to your individual preferences.

The DuoFern settings in menu 9.9 are introduced and described separately from page 102 onwards.

Menu 9 - System settings

Symbol	Menu	Page
SET	9.1 Time and date	77
	9.5 Week programme	78
i	9.7 Installer settings	80
	9.8 Device settings	92
	9.9 DuoFern settings	102

-  Open menu **9.1**.
Configure and confirm the desired settings.

Setting order:

-  Time
-  Date
Day.Month
-  Year
2000 to 2099

You can adapt the automatic heating phases individually to the weekly profile using the week programmes.

There are three week programmes available:

[1] Weekly switching times (factory setting)

The switching times of the automatic heating phases apply from (Mon Sun) **[MO SO]** .

[2] Working day and weekend switching times

Separate switching times for (Mon Fri) **[MO FR]** and (Sat + Sun) **[SA + SO]** .

[3] Individual day switching times

The switching times of the automatic heating phases can be set for each individual weekday.



Once a week programme has been selected and confirmed, menu 2 opens automatically to set the heating phases.

1. Open menu **9.5**.



2. Select and confirm the desired week programme.

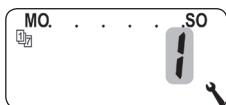

3. Menu **2** opens automatically to set the heating phases after selecting a week programme, see page 60.

The settings in menu 9.7 must be checked and adapted to the existing heating installation after completing the installation wizard.

Menu 9.7 - Installer settings

Symbol	Menu	Page
	9.7.1 Heating mode.....	81
OFFSET	9.7.2 Sensor offset	85
H	9.7.3 Hysteresis and minimum on-time	86
	9.7.4 Valve protection	87
▼	9.7.5 Frost protection	88
	9.7.6 Valve mode	89
SENSOR	9.7.7 Sensor test	91

You can set the DuoFern Room Thermostat 9485 for one of the following heating modes.

There are three heating modes available:

[1] Room temperature controller (factory setting)

The heating is switched on when the room temperature drops below the set target temperature.

[2] Room temperature controller with limiter

This function can be used for floor heating with particularly sensitive floor coverings. Excessive cooling of the floor can also be prevented with additional heat sources (e.g. fireplace) by defining a minimum floor temperature. It is absolutely essential to connect the device to the external Remote Sensor 9485-F for this heating mode.

The heating is switched on when the room temperature drops below the set target temperature. The room temperature is measured with the internal sensor.

The floor temperature is measured by the external Remote Sensor 9485-F regardless of the room temperature. The set minimum and maximum floor temperature is taken into account in the heating control and limited accordingly.

[3] Cooling function

The air conditioning is switched on when the room temperature exceeds the set target temperature.



Additional parameters must be set in each heating mode.

1. Open menu **9.7.1**.

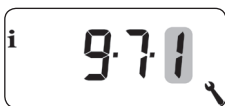

2. Continue with the desired heating mode.

2.1 Heating mode [1] - Setting the room temperature controller.

- 2.2 Select and confirm the heating mode [1].



- 2.3 Select and confirm the internal [I] or external [E] temperature sensor.



2.1 Heating mode [2] - Setting the room temperature controller with limiter.

2.2



Select and confirm the heating mode [2].

2.3



Set and confirm the limiting value for the minimum floor temperature.

Setting range = 10°C to 30 °C

Factory setting = OFF



The setting is undertaken in steps of 1.0 °C.

2.4



Set and confirm the limiting value for the maximum floor temperature.

Setting range = 20°C to 40 °C

Factory setting = 35 °C



The setting is undertaken in steps of 1.0 °C.



If both a minimum and maximum temperature limit are set, the limiting values must be at least 5 °C apart.

- ◆ An incorrect setting is automatically corrected by the controller.

2.1 Heating mode [3] - Setting the cooling function.

2.2



Select and confirm the heating mode [3].

2.3



Select and confirm the internal [I] or external [E] temperature sensor.





The temperature measured on site can vary from the room temperature if the DuoFern Room Thermostat 9485 is installed in a unfavourable position (e.g. behind a curtain or on a cool exterior wall).

Setting range

An adjustment of the measurement in the range of -5°C to $+5^{\circ}\text{C}$ can be carried out using the sensor offset. The setting is undertaken in steps of 0.1°C .

1.  Open menu **9.7.2**.
- The image shows a thermostat display with the text 'i OFFSET' on the left. The main display shows '9.7.2' followed by a degree symbol and 'C'. A small wrench icon is visible at the bottom right of the display area.

2.  Set the offset for the internal temperature sensor.
e.g. -1.5°C
- The image shows the thermostat display with 'i OFFSET' on the left. The main display shows '1-' followed by '1.5' and a degree symbol and 'C'. A small wrench icon is visible at the bottom right of the display area.

3.  Set the offset for the external temperature sensor.
e.g. 0.5°C
- The image shows the thermostat display with 'i OFFSET' on the left. The main display shows 'E' followed by '0.5' and a degree symbol and 'C'. A small wrench icon is visible at the bottom right of the display area.

This function prevents an unnecessary large number of switching operations by setting a minimum on-time for the relay. This prevents the DuoFern Room Thermostat 9485 tripping too often if the room temperatures fluctuate.

1.

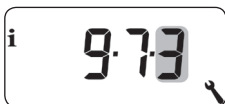

Open menu **9.7.3**.

2.



Set the hysteresis.

Setting range = 0.1°C to 5 °C

Factory setting = 0.2°C

3.



Set the minimum on-time.

**Setting range = 1 minute to
10 minutes**

Factory setting = 2

If an electrothermal control valve (e.g. for floor heating) is not activated for a longer period of time (e.g. in summer), it may get stuck.

Prevent the control valve getting stuck with the "Valve protection" function.

The valve is switched on for a set time at 10:00 if it has not been activated for longer than 3 days (>72 hours).

1. Open menu **9.7.4**.



2. Switch on the valve protection.



On = Valve protection on
OFF = Valve protection off

3. Set the minimum on-time.



e.g. 3 minutes

The "Frost protection" function switches the heating on when the minimum temperature has been reached. The function is independent of the set target temperatures.

1.  Open menu **9.7.5**.

2.  Switch on the frost protection.
On = Frost protection on *
OFF = Frost protection off

3.  Set the minimum temperature at which the heating is switched on.
e.g. 4.0 °C *
Factory setting = On; 4.0 °C
Setting range = 2.0 °C - 10 °C

Electrothermal valves with the switching states "**normally closed (NC)**" or "**normally open (NO)**" are often used for heating control. You can set the respective valve mode in menu 9.7.6 to adapt to the control valve used in each case:

[NC] Valve mode normally closed

The control valve remains closed in an isolated, de-energised state.

[NO] Valve mode normally open

The control valve remains open in an isolated, de-energised state.



The set valve mode also applies to DuoFern actuators connected via radio.

1. Open menu **9.7.6**.



2. Switch on the valve protection.



nc = normally closed
no = normally open



Switch off the relay if the control valve is regulated by a Duofern actuator.

If the control valve is regulated solely by a DuoFern actuator, you can switch off the relay to avoid annoying switching noises.

 5 sec.

Press the minus button for 5 seconds to switch the relay off.

Display when the relay is switched off:
– **no** or – **nc**

 5 sec.

Press the plus button for 5 seconds to switch the relay on.

It is possible to view the readings of the temperature sensors (internal and external) to check the installation.

1.



Open menu **9.7.7**.

2.

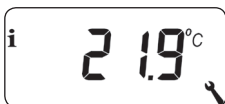

Select and display the desired temperature sensor.

Example: The internal temperature sensor measures 21.9 °C.



Example:

The external Remote Sensor 9485-F measures 19.8 °C.



Example:

The external Remote Sensor 9485-F is incorrect or not connected.



Menu 9.8 - Device settings

Symbol	Menu	Page
	<i>9.8.1</i> Automatic summer / winter changeover.....	93
	<i>9.8.3</i> Display lighting	94
	<i>9.8.5</i> Button lock	95
▼	<i>9.8.6</i> Holiday mode	97
▲	<i>9.8.7</i> Party mode	99
	<i>9.8.0</i> Software version	101



17.1 Menu 9.8.1 - Switching the automatic summer/ winter time on/off

EN

The DuoFern Room Thermostat 9485 features an automatic summer/winter changeover function.

Summer time

The timer is changed to summer time on the last Sunday in March. The timer is set back one hour at 02:00.

Winter time

The timer is changed to winter time (standard time) on the last Sunday in October. The timer is set back one hour at 03:00.

Recommendation for operating the device outside Germany

If the DuoFern Room Thermostat 9485 is not being used in Germany, it may be necessary to switch off the automatic summer/winter changeover function.

1.



Open menu **9.8.1**.

2.



Switch the summer/winter changeover function on/off and confirm.

OFF = Function off

On = Function on



17.2 Menu 9.8.3 - Setting the display lighting

EN

Pressing one of the operating buttons switches the background lighting on the display on and off after a predetermined time.

- ◆ After 10 seconds on the standard display
- ◆ After approx. 1 minute in the menus

You can set the desired brightness level if the background lighting should remain permanently lit up in an idle state (without pressing a button).

1.



Open menu **9.8.3**.

2.



Set and confirm the desired brightness levels.

- 0** = Switch off the permanent display lighting
- 1** = Weak brightness
- 2** = Average brightness
- 3** = Maximum brightness



17.3 Menu 9.8.5 - Switching the button lock on/off

EN

You can activate the automatic button lock to protect against any unintentional input.

1.



Open menu **9.8.5**.

2.



Switch the button lock on/off and confirm.

OFF = Button lock off

On = Button lock on

Automatic activation after approx. two minutes

If the button lock is activated and no buttons are pressed within a period of two minutes, the button lock is switched on automatically.

If an attempt is made to call up the menu when the button lock is active, the display flashes.

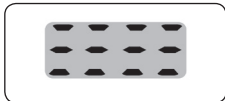



The button lock is deactivated manually on the standard display



4 sec.

Press and hold for 4 seconds.

The button lock is activated manually on the standard display before the time limit expires



4 sec.

Press and hold for 4 seconds if you want to activate the automatic button lock before the two minutes expire.



Manual operation of the DuoFern Room Thermostat 9485 is also possible when the button lock is active.



17.4 Menu 9.8.6 - Setting the holiday mode incl. the setback temperature

EN

You can switch on a holiday mode and set the desired setback temperature on the DuoFern Room Thermostat 9485. The holiday mode can then be directly activated on the standard display.

The heating is regulated to the setback temperature when the holiday mode is activated.

1.



Open menu **9.8.6**.

2.



Switch the holiday mode on/off and confirm.

OFF = Holiday mode off

On = Holiday mode on

3.



Set and confirm the setback temperature.

e.g. 17.0 °C



17.4 Menu 9.8.6 - Setting the holiday mode incl. the setback temperature

EN

Activating the setback temperature temporarily on the standard display

-  1 sec. Press and hold for 1 second to temporarily activate the setback temperature. The heating is regulated to the setback temperature until the next automatic heating phase becomes active.

Manual mode



The hand symbol is shown if you press the button briefly.

Activating the setback temperature permanently on the standard display (holiday mode)

-  4 sec. Press and hold for 4 seconds to permanently activate the setback temperature (holiday mode). The automatic heating phases have been deactivated.

Automatic mode off



The clock symbol disappears when you press and hold the button.



17.5 Menu 9.8.7 - Setting the party mode incl. the comfort temperature

EN

You can switch on a party mode and set the desired comfort temperature on the DuoFern Room Thermostat 9485. The party mode can then be directly activated on the standard display.

The heating is regulated to the comfort temperature when the party mode is activated.

1.



Open menu **9.8.7**.

2.



Switch the party mode on/off and confirm.

OFF = Party mode off

On = Party mode on

3.



Set and confirm the comfort temperature.

e.g. 21.5 °C



17.5 Menu 9.8.7 - Setting the party mode incl. the comfort temperature

EN

Activating the party mode temporarily on the standard display

 1 sec.

Press and hold for 1 second to temporarily activate the party mode. The heating is regulated to the comfort temperature until the next automatic heating phase becomes active.

Manual mode



The hand symbol is shown if you press the button briefly.

Activating the party mode permanently on the standard display

 4 sec.

Press and hold for 4 seconds to permanently activate the party mode. The automatic heating phases have been deactivated for this.

Automatic mode off



The clock symbol disappears when you press and hold the button.



17.6 Menu 9.8.0 - Displaying the software version

EN

This menu enables the current software version of the DuoFern Room Thermostat 9485 to be displayed.

1.



Open menu **9.8.0**.

2.



Subsequently the current software version is displayed.

3.



Carry out a display test.

4.



Back to the menu 9.8 Device settings.



In order for your DuoFern Room Thermostat 9485 to receive and send control signals in the DuoFern network, it is necessary to log any desired DuoFern device (e.g. DuoFern actuator etc.) on to the DuoFern Room Thermostat 9485.



To do so, please also read the operating manual of the respective DuoFern device.

Maximum number of connected devices

You can log a maximum of 20 DuoFern devices on to a DuoFern Room Thermostat 9485.

Additional information about logging on can be obtained from the login matrix on our website at:

www.rademacher.de

Menu 9.9 - DuoFern settings

Symbol	Menu	Page
	9.9.1 Logging on and off.....	103
	9.9.2 Setting the DuoFern mode	107
	9.9.3 Setting the transmission channel	109
i 	9.9.4 Switching the weather data on/off	110
i IST	9.9.5 Displaying the DuoFern address (radio code)	112



1. Open menu **9.9.1**.



2. The number of DuoFern devices logged on is displayed.
For example, one device is logged on here.



3. Logging on DuoFern devices.

- 3.1 Switch the respective DuoFern device to login mode.



- 3.2 Start the login procedure.



- 3.3 The display flashes [**On**].



- 3.4 The new number of logged-on devices is displayed after a successful login.



- 3.5 Log on the next DuoFern device

or

Back to the menu selection.



4. Logging off DuoFern devices.

4.1



Switch the respective DuoFern device to log-off mode.

4.2



Start the log-off procedure.

4.3



The display flashes [**OFF**].

4.4





The new number of logged-on devices is displayed after a successful log-off.

4.5 Log off the next DuoFern device
or
Back to the menu selection.



Deleting all connections to the logged-on DuoFern devices

1.  4 sec. Press and hold the set button for 4 seconds.
-

2.  The display flashes [**OFF**].
-

3.  Subsequently all of the connections are deleted.



Deleting the connections can lead to problems for the participants, whereby the DuoFern Room Thermostat 9485 is still logged on after the deletion process.

- ◆ Always use the "Log-off" function to terminate the connection with other DuoFern devices.



Clearing up the DuoFern network

This function enables you to log off all DuoFern devices from the DuoFern Room Thermostat 9485 that are no longer accessible via radio.



All battery-operated DuoFern transmitters (e.g. the DuoFern manual central operating unit) cannot be logged off using this function.

1.



Open menu **9.9.1**.

2.



The number of DuoFern devices logged on is displayed.

3.



4 sec.

Activate the clear up function.

In order to do this, press and hold the SET button for approx. 4 seconds.

4.

The display flashes.

4.1



The current number of DuoFern devices logged on (e.g. 2) is displayed after a successful clear up.



The DuoFern Room Thermostat 9485 features two DuoFern modes that enable you to specify how it behaves within the DuoFern network or in the local installation on site.

Setting heating phases centrally in the HomePilot® or locally in the DuoFern Room Thermostat 9485

[1] DuoFern receiver

- ◆ Heating phases are controlled centrally (e.g. through scenes), for example, by the HomePilot®
- ◆ No local heating phases can be set and activated in this mode

[3] Local operation (factory setting)

- ◆ The heating phases set in the DuoFern Room Thermostat 9485 are stored locally
- ◆ In addition, control commands can also be received and executed from the DuoFern network (e.g. from a DuoFern manual transmitter)



All manual and automatic control signals received via radio are executed on site regardless of the set mode.



1.



Open menu **9.9.2**.

2.



Set and confirm the desired DuoFern mode.

1 = DuoFern receiver

3 = Local operation



18.3 Menu 9.9.3 - Setting the transmission channel **EN**

If a DuoFern actuator is logged on to the DuoFern Thermostat 9485 via radio, a control valve can be regulated by this. Direct cabling between the DuoFern Room Thermostat 9485 and the control valve is not required.

If a multi-channel DuoFern actuator is used for this, the channel that is used must be set on the DuoFern Room Thermostat 9485.



Pay attention when wiring the DuoFern actuator to the control valve to the channel used and check that the control valve actually also controls the control commands of the DuoFern Room Thermostat 9485.

1.



Open menu **9.9.3**.

2.

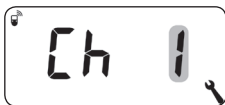

Set and confirm the transmission channel.

1 = Channel 1

2 = Channel 2

A = All channels





18.4 Menu 9.9.4 - Switching the weather data on/off

EN

The DuoFern Room Thermostat 9485 can receive and display weather data (temperature, brightness, wind velocity and rain) from a DuoFern Environmental Sensor. It is not necessary to log the DuoFern Environmental Sensor on to the DuoFern Room Thermostat 9485.

The weather data can be called up and displayed directly on the standard display, see page 54.

Maximum number of environmental sensors

- ◆ A maximum of 4 environmental sensors are detected
- ◆ Only one sensor can ever be selected as the source

Observing delays in displaying the weather data



Environmental sensors update the weather data approx. every 5 minutes and therefore it can take a few minutes for the weather data to be displayed after the settings are configured.

- ◆ This also applies after a power failure.
- ◆ If no new weather data is received for 45 minutes, this is no longer available.



18.4 Menu 9.9.4 - Switching the weather data on/off

EN

1.  Open menu **9.9.4**.

2.  Switch the weather data display on/off and confirm.



OFF = Off

On = On

3.  The last four digits of the DuoFern address (radio code) of the current environmental sensor are displayed.



Display if no environmental sensor has been received or is in radio range so far.

4.  /  Select and confirm the desired environmental sensor.

Deleting all detected environmental sensors



Briefly press the SET button.

All environmental sensors are deleted.



18.5 Menu 9.9.5 - Displaying the DuoFern address (radio code)

EN

Each DuoFern device has an address (radio code) via which it communicates on the DuoFern network. If necessary, you can display the DuoFern address of the DuoFern Room Thermostat 9485.

1.  Open menu **9.9.5**.



2.  Two digits of the six-digit address are always shown in the form of scroll text, see example.



3. **M** or **OK** Back to the menu selection.



19. Logging on to the HomePilot®

Your DuoFern Room Thermostat 9485 must be logged on once for it to be set and monitored by the HomePilot®.

1. Open the user interface of the HomePilot® and click in the bottom left on the [**Configuration**] button and then on [**Actuators**] and [**Logging on devices**].

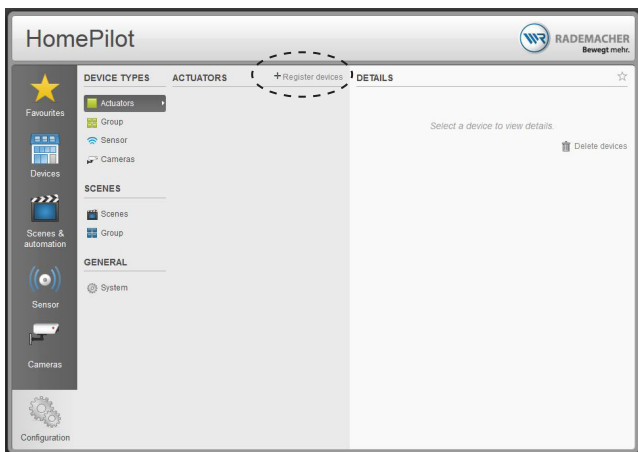



19. Logging on to the HomePilot®

EN

2. Activate the login procedure of the DuoFern Room Thermostat 9485 in menu 9.9.1, see page 103.
3. Two devices are displayed in the left table after successfully logging on:
 - ◆ A room thermostat (actuator)
 - ◆ A temperature sensor (sensor)

Register devices...

NEW DEVICES

Thermostat actuator Kitchen

Thermostat sensor

Please enter a name and description for the device
Thermostat actuator.

Click "Locate" in order to find the device again, if necessary. Close the configuration screen for this device with "Save".

Surname: Thermostat actuator Kitchen

Description:

Symbol: Thermostat

Save

4. Click on the desired device and assign an individual name or a different description, if required. In addition, a graphic symbol can be selected for the logged-on device.
5. Save the settings.

The logged-on device is then listed on the left under sensors and devices and can be used immediately.



The following actuator settings are available under [**Configuration -> Actuators -> Room thermostat**] :

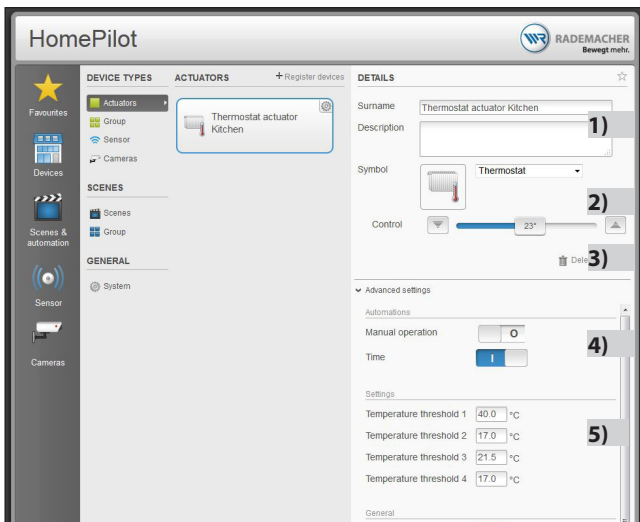

- 1) Name and description for the DuoFern Room Thermostat 9485
- 2) Select the desired symbol
- 3) Change the target temperature manually
- 4) Select manual operation or automatic timer
- 5) Set target temperatures 1-4. The values correspond to the target temperatures stored in menu 3 of the DuoFern Room Thermostat 9485



The following actuator settings are available under [**Configuration -> Sensors -> Temperature sensor**] :

The screenshot shows the HomePilot configuration interface for a 'Thermostat sensor Kitchen'. The interface is organized into several sections:

- Left Sidebar:** Contains navigation icons for Favourites, Devices, Scenes & automation, Sensor, and Cameras.
- Top Bar:** Displays 'HomePilot' and the 'RADEMACHER' logo with the tagline 'Bewegt mehr.'.
- Navigation Tabs:** 'DEVICE TYPES', 'SENSOR', and '+ Register devices'.
- SENSOR Section:** Shows a selected device 'Thermostat sensor Kitchen' with a 'WR' logo.
- DETAILS Section:**
 - Surname:** 'Thermostat sensor Kitchen' (Callout 1)
 - Description:** An empty text field (Callout 1)
 - Symbol:** A dropdown menu showing 'Default' with a 'WR' logo icon (Callout 2)
 - Automations:** A section with a small icon and a 'Delete devices' button.
- Advanced settings Section:**
 - Settings:** Four temperature threshold inputs: 40.0 °C, 17.0 °C, 21.5 °C, and 17.0 °C (Callout 3).
 - General:** Includes 'Visibility' (checked), 'Invert symbol' (unchecked), 'Remote log-on' (Start button), and 'Remote log-on/off' (Stop button).

- 1) Name and description for the temperature sensor
- 2) Select the desired symbol
- 3) Set target temperatures 1-4. The values correspond to the target temperatures stored in menu 3 of the DuoFern Room Thermostat 9485



19.3 Sample automation of a temperature-dependent skylight control

EN

Scenes must be created to be able to control other devices with the temperature sensor of the DuoFern Room Thermostat 9485. A skylight is controlled by the target value 3 in the following example.

1. A scene to open the skylight if the set target temperature is exceeded (target value 3).

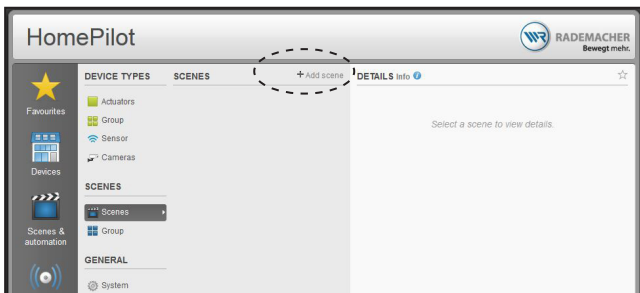

2. Add the desired device (skylight) to the scene and set the desired target state (100%).

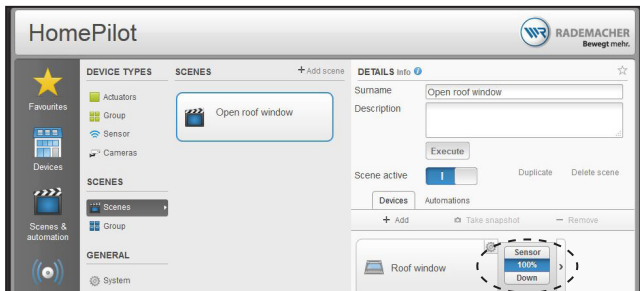



19.3 Sample automation of a temperature-dependent skylight control

EN

3. Add automation to the scene.

Select "Temperature" as the automation, select the desired sensor and remove the tick on "Temperature insufficient". In addition, select the desired weekdays for the automation.

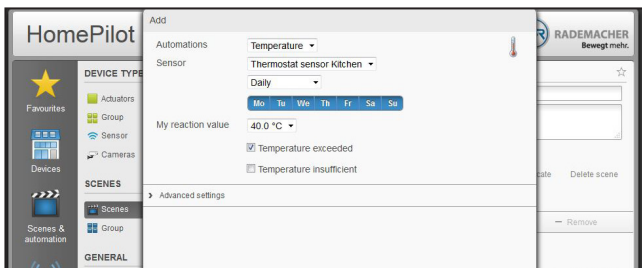

4. Automation set up.

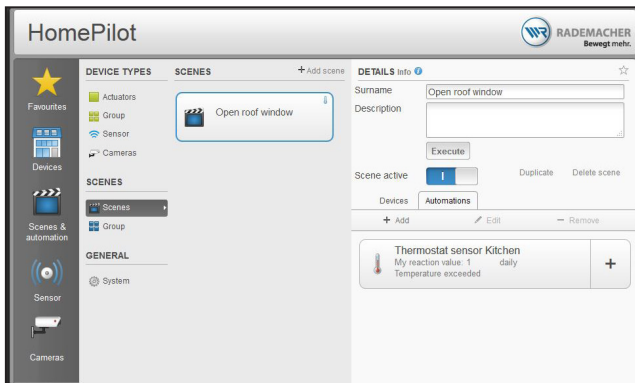



19.3 Sample automation of a temperature-dependent skylight control

EN

- Now create a further scene and also add the desired device (skylight) to this and set the desired target state as "Temperature insufficient" (0%).

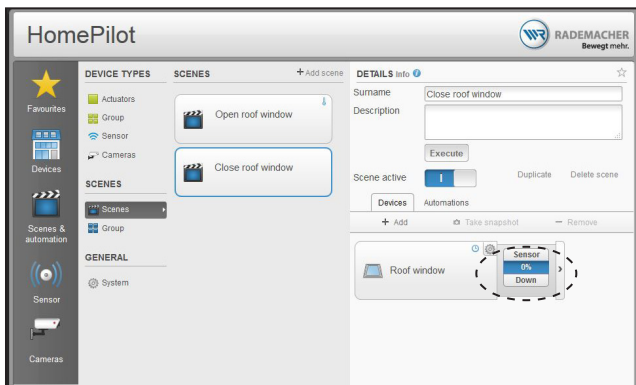

- Also add automation to this scene. Select "Temperature" as the automation, select the desired sensor and remove the tick on "Temperature insufficient". In addition, select the desired weekdays for the automation on which the automation should apply.

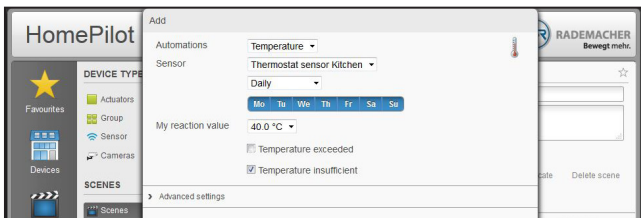





A software reset can be carried out to reset the DuoFern Room Thermostat 9485 to the original default condition as when supplied.





All settings in menu **"9.7 Installer settings"** are also lost in the process.

- ◆ Make sure that you note all settings in menu 9.7 before carrying out a software reset and check these after the reset.

1.  +  +  +  Press and hold the four buttons simultaneously for five seconds until all of the symbols are shown on the display.



2.   The software version is then shown for five seconds.
All settings are deleted and reset to the default factory settings.

3. Start with the settings as specified from page 48 onwards (installation wizard).



The DuoFern connection data is retained after a software reset. You can log off or delete DuoFern devices in menu 9.9.1, see page 103.

A hardware reset can be carried out in the event that the DuoFern Room Thermostat 9485 no longer react to commands.

1. To do so, pull the operating unit out of the installation housing.

⚠ ATTENTION!

Risk of damage due to the overheating or excessive cooling of the room or flooring.

The relay output remains unchanged if the operating unit is pulled out of the installation housing during operation. Control and limiting functions where appropriate are no longer provided.

- ◆ Make sure that a relay state that poses no risk is set before removing the operating unit.
- ◆ Switch off the central heating or air conditioning beforehand if necessary.

-
2. Two contacts, which must be carefully bridged for a few seconds, for example, with the help of a flat-head screwdriver, are located in the centre of an opening on the rear of the operating unit.

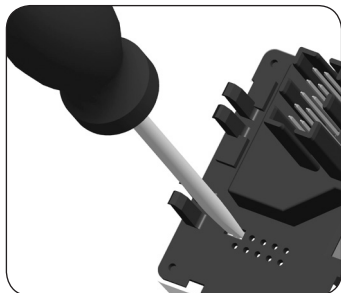

3. The operating unit can be reinserted into the installation housing as soon as the screwdriver has been removed from the contacts.

The time and date are lost during a hardware reset.
All other settings are retained.

Error 1

The DuoFern Room Thermostat 9485 has an invalid DuoFern address (radio code).

- ◆ Please carry out a hardware reset, see page 121.
- ◆ Check the DuoFern address (radio code) in menu 9.9.5 if the problem persists, see page 112.
 - Please then contact the RADEMACHER Service department, see page 128.

Error 2

The DuoFern Room Thermostat 9485 has overheated and switched off for safety reasons.

- ◆ It is very likely that a large load has been connected.
- ◆ The maximum permissible connected loads can be found in the technical specifications, see page 30.
- ◆ The error message can only be confirmed by pressing the OK button when the device is no longer overheating.

Error 2



The DuoFern Room Thermostat 9485 does not function until the error has been confirmed. The controller is switched off.

Error 3

There is a communication problem.

- ◆ Check that all logged-on actuators and the HomePilot® if necessary are connected properly and are within range.
- ◆ A repeater may be required for larger distances.
Each DuoFern device that is connected to the mains power supply is a repeater (e.g. switch actuator sockets, HomePilot®, DuoFern actuators etc).
- ◆ If devices have been logged on that are no longer available (e.g. due to a defect, amongst other things), these can be deleted by the "Clear up" function, see page 106.
- ◆ In the event of a transmission error, the device makes an attempt to reach the DuoFern actuator or the HomePilot® again every 10 minutes.
The error message disappears automatically if this is successful.

Error 4

The temperature sensor provides invalid readings.

- ◆ Carry out a hardware reset, see page 121.
- ◆ If an optional external temperature sensor (Remote Sensor 9485-F) is connected, please check the cabling.
- ◆ Please contact the RADEMACHER Service department if only the internal sensor is used and the problem still persists, see page 128.
- ◆ The readings of the sensors can be checked in menu 9.7.7, see page 91.
- ◆ The controller switches to an emergency mode in the event of a faulty sensor by switching on for 6 minutes (30%) and switching off for 14 minutes (70%). This prevents excessive cooling of the room and overheating of the floor.



There is a risk of fatal electric shock when touching electrical components.

- ◆ Disconnect all phases of the mains power cable and secure it to prevent any reconnection. Check that the system is de-energised.

1. Log the DuoFern Room Thermostat 9485 off the DuoFern network.
2. Switch off the mains power, secure it from restarting and check that the system is de-energised.
3. Carefully pull the operating unit out of the installation housing.
4. Remove the frame.
5. Release the claw fasteners of the installation housing and pull it out of the flush-mounted box.
6. Disconnect the connecting cable from the installation housing.
7. Secure the connection point against restarting and the connecting cable from unintentional contact.



24. Simplified EU Declaration of Conformity

EN



RADEMACHER Geräte-Elektronik GmbH hereby declares that the DuoFern Room Thermostat 9485 complies with the Directive **2014/53/EU (Radio Equipment Directive)**.

The full text of the declaration of conformity is available at the following website:

www.rademacher.de/ce



25. Accessories

Remote Sensor 9485-F

Item no. 7000 01 03



RADEMACHER Geräte-Elektronik GmbH provides a 24-month warranty for new systems that have been installed in compliance with the installation instructions. All construction faults, material defects and manufacturing defects are covered by the warranty.

Your statutory warranty claims remain unaffected by this warranty.

The following are not covered by the warranty:

- ◆ Incorrect fitting or installation
- ◆ Non-observance of the installation and operating instructions
- ◆ Improper operation or wear and tear
- ◆ External influences, such as impacts, knocks or weathering
- ◆ Repairs and modifications by third parties, unauthorised persons
- ◆ Use of unsuitable accessories
- ◆ Damage caused by unacceptable excess voltages (e.g. lightning)
- ◆ Operational malfunctions caused by radio frequency overlapping and other such radio interference

A prerequisite for the warranty is that the new device must have been purchased from one of our approved specialist retailers. Proof of this must be provided by presenting a copy of the invoice.

RADEMACHER will remedy any defects that occur within the warranty period free of charge either by repair or by replacement of the affected parts or by supplying a new replacement unit or one to the same value. There is no general extension of the original warranty period by delivery of a replacement or by repair as per the terms of the warranty.

RADEMACHER

Geräte-Elektronik GmbH
Buschkamp 7
46414 Rhede (Germany)
info@rademacher.de
www.rademacher.de

Service:

Hotline 01807 933-171*
Fax +49 2872 933-253
service@rademacher.de

* 30 seconds free of charge, subsequently
14 cents / minute from German fixed line
networks and max. 42 cents / minute from
German mobile networks.