

Safety Instructions

1, 2, 3, 4, 5, 6, 7, 10, 12, 13, 14, 15, 16,
17, 18, 19, 20, 21, 22, 24, 28, 33, 34



Info

www.paulmann.com

Paulmann Licht GmbH
Quezinger Feld 2
31832 Springe
Germany

www.paulmann.com

Art.-Nr.: 929.70
929.71
929.72
929.73
929.74
929.75
929.76



929.70_929.72_929.74

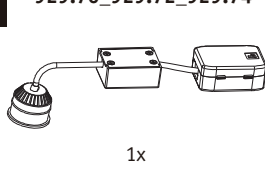

1x

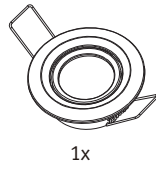

1x



2x

929.76

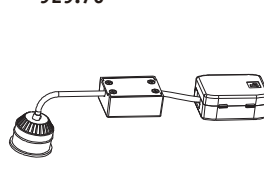

1x



2x

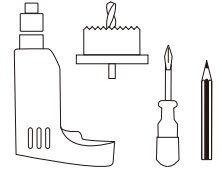

(+MA326) PSPU 01/20



929.71_929.73_929.75

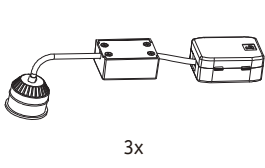

3x

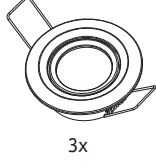

3x



6x

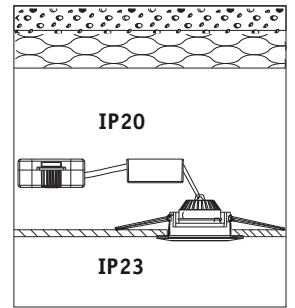
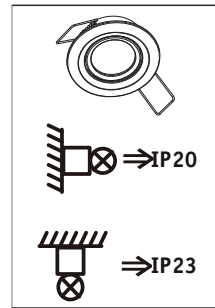
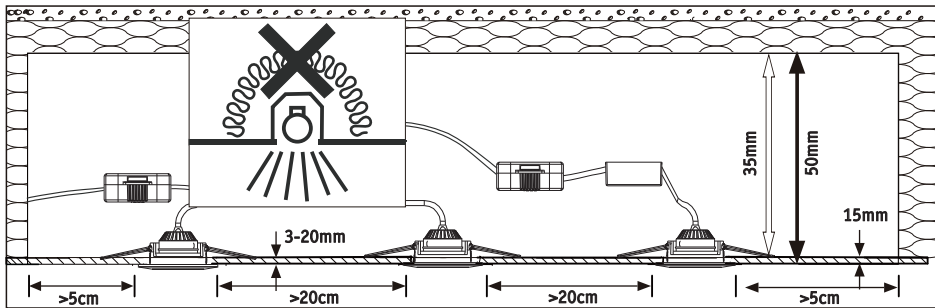

A

Safety Instructions
Nr. 1, 4, 5, 7

off

item number	hole size
929.70_929.71	ø54mm
929.72_929.73	ø54mm
929.74_929.75	ø55mm

ø x mm

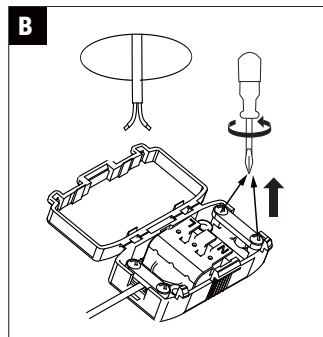

C

a. ø8-12mm 7mm 14mm





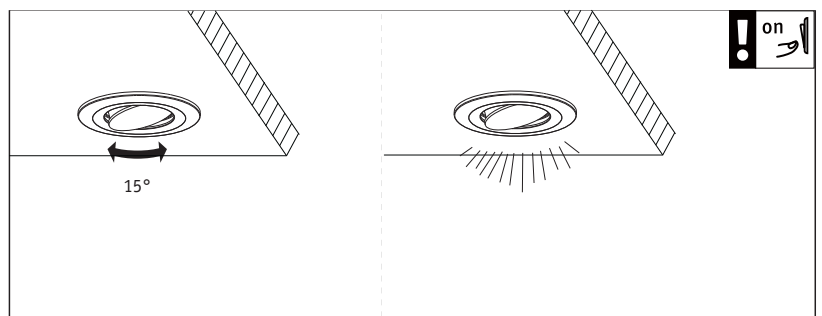
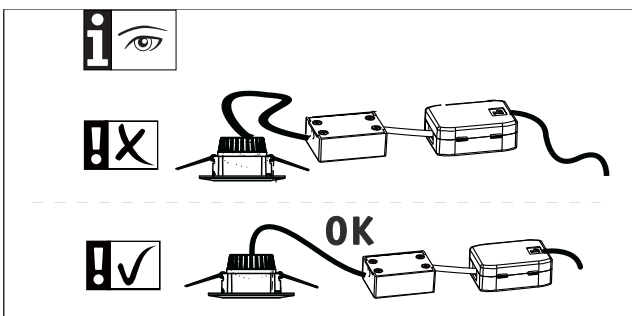
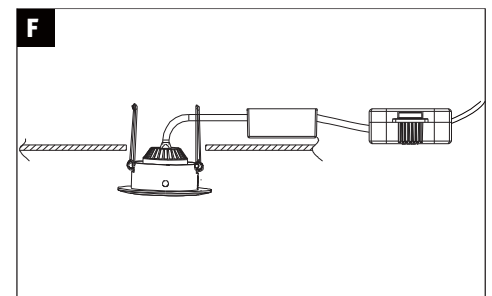
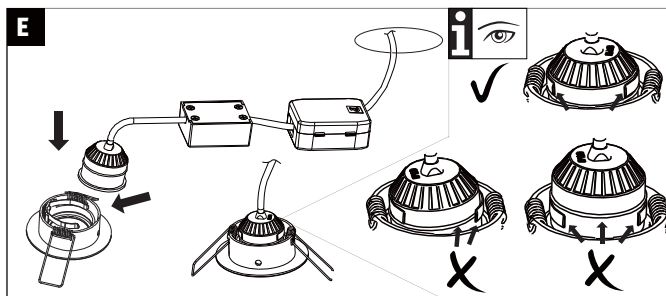
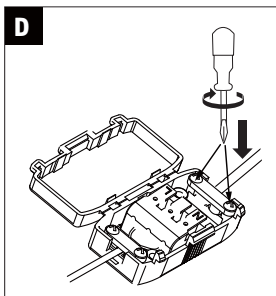

230V-

b.

Nr. 3, 4, 5, 6

230V-

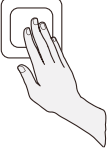
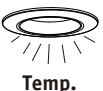

 Preset preset brightness (original preset brightness = max. brightness)	 Max. max. brightness	 brightness to dark	 on 
 Temp. temporary brightness	 Min. min. brightness	 brightness to bright	

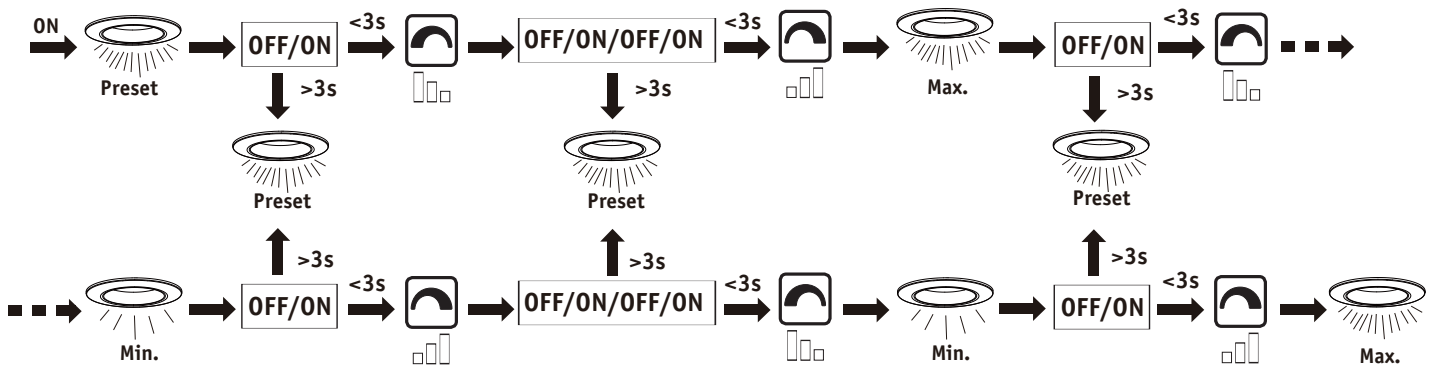
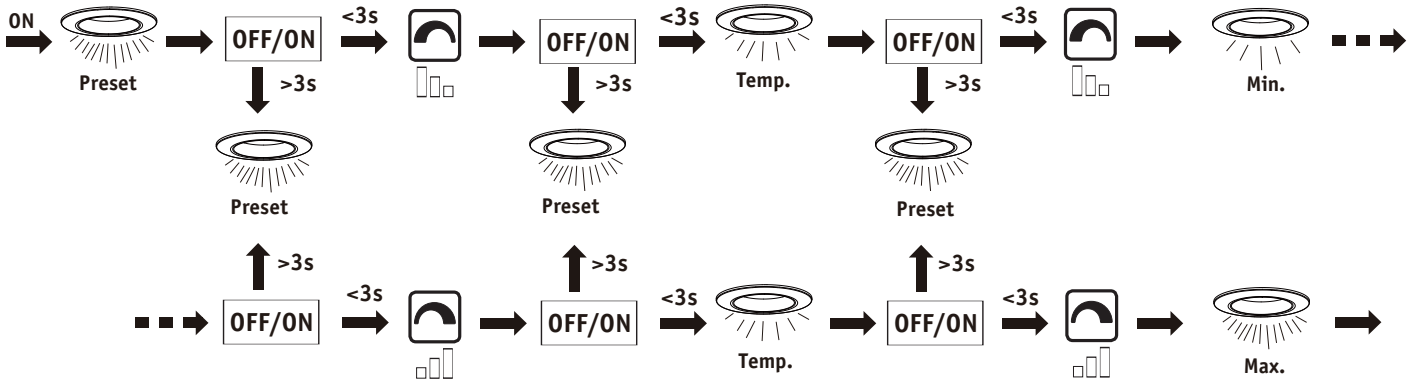

• Preset-function •

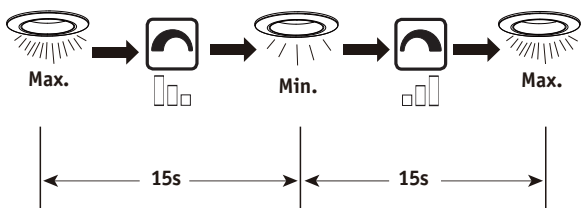
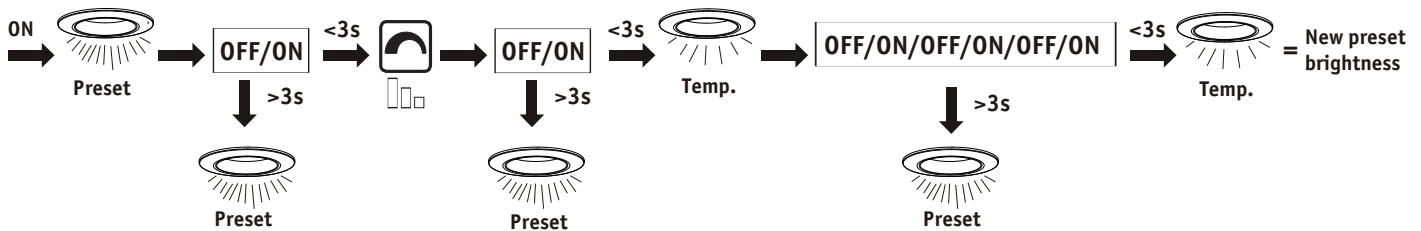

ENERG Y IJA IE IA
енергия · ενεργεια

A+

A++
A+
A
B
C
D
E

5 kWh/1000h

300 lm
4.2 W
230 V

∇ warm white
2700K

CRI/Ra ≥ 80

ON OFF  ≥50.000

≈30x 1.000h

Lumen 60% <1 s

∅35 mm

  21 PAP  390092976