

Audo

COPENHAGEN

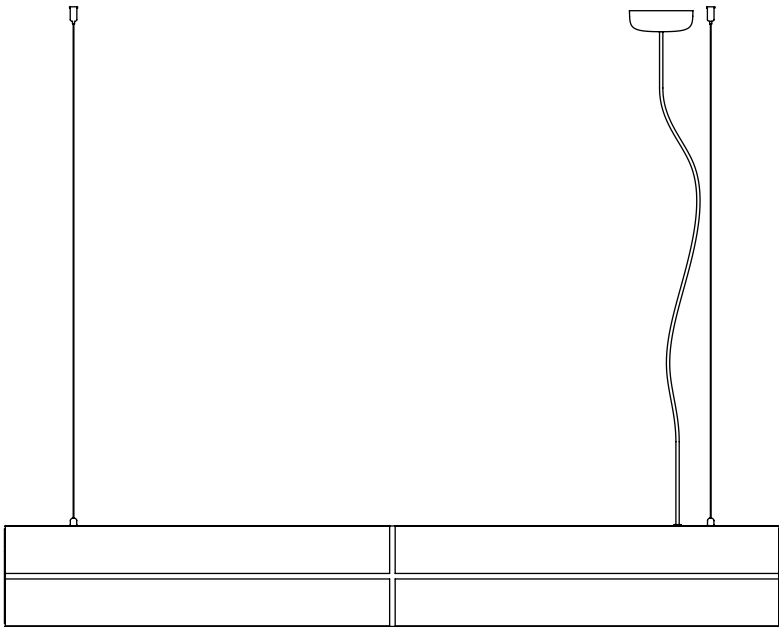

HASHIRA LINEAR LAMP
Design by *Norm Architects*

Congratulations on your new HASHIRA LINEAR LAMP designed by *Norm Architects* for Audo Copenhagen. We hope you will enjoy using it.

Please follow these instructions carefully to ensure the safe and correct installation of your new lamp.

感谢您购买由 Norm Architects 设计的 HASHIRA LINEAR 吊灯, 希望您会喜欢此产品, 并依照这份说明以确保正确安装产品。

为了您的安全, 在使用产品之前, 请您仔细阅读本产品说明书。

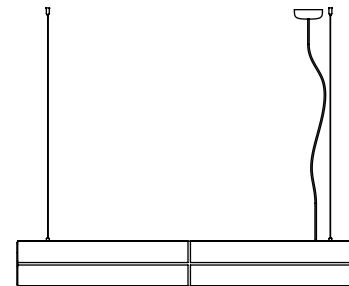

1 x Lamp

2 x Covers

Note

Contact a qualified electrician if you experience any issues during installation. The external cable cannot be replaced. If damaged, it must be replaced only by the manufacturer, their service agent or another qualified individual.

注意事项

如果您在安装过程中遇到任何问题, 请联系专业的电工。
此灯具的电源线不能替换; 如有损坏, 请联系制造商、服务代理或由专业的电工替换。

Warning

Improper installation, adjustment, alteration, service, maintenance or use can cause personal injury or property damage. Before installing, always turn off the power for the circuit.

警语

不正确的产品安装、调整、改造、维护或使用不当，可能会导致您的人身伤害或财产损失。因此安装前，请务必关闭电路电源。

Caution

Keep this product and its packaging out of children's reach.

安全注意

请将本产品及其包装放置于儿童接触不到的地方。

Disposal

At the end of its life, dispose of this lamp in the correct waste bin or at a recycling station. Do not discard as household waste. Your local authority can provide further information on where and how it can be disposed of. The EU Waste from Electrical and Electronic Equipment (WEEE) Directive 2005 encourages the recycling of this item.

回收处理方式

此产品使用寿命结束时，将此灯丢弃在正确的垃圾箱或回收站。请勿作为生活垃圾丢弃。查询您的地方当局所提供有关如何处置它的方式及更多信息。2005年欧盟废弃电子电机设备指令(WEEE) 鼓励回收该物品。

Important Information

Due to the wide diversity of wall or partition types, we cannot provide you with suitable attachment fixtures. To determine which attachment fixtures to use, you will need to identify the type of wall to which you will be fixing this product. Here are some examples of attachment fixtures recommended for:

重要资讯

由于墙面类型的多样性，我们无法为您提供合适的固定装置配件。为了确定您要使用的固定装置配件，您需要确定安装此产品的墙面类型。以下是一些参考示意图：

Blind Walls



"Fischer" Nylon plug



Metal wall plug

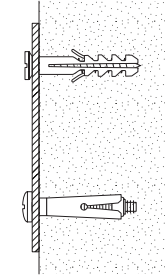

Studded Walls



Nylon winged plug



Metal expansion plug



"Molly" plug

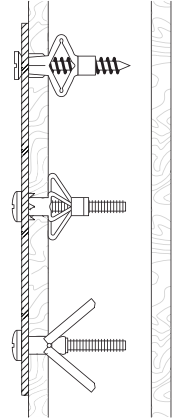

Hashira Linear
T5 LED tube (replaceable)
Dimmable
Watt: 16 Lumen: 1900
Kelvin: 2700 CRI: >80
Energy Class: E

Dimmable using a TRIAC dimmer

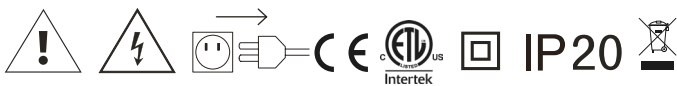
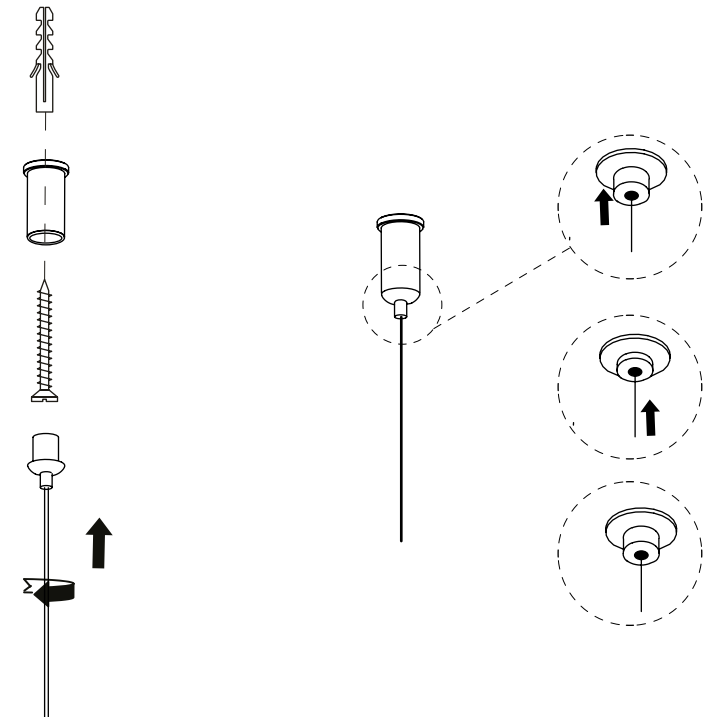
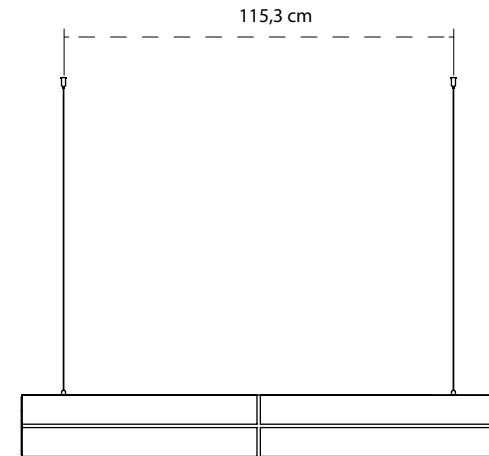

2

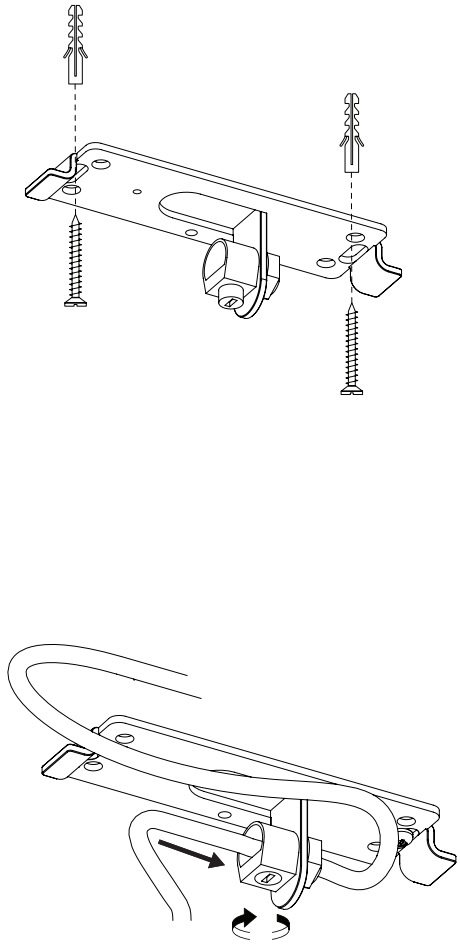

3

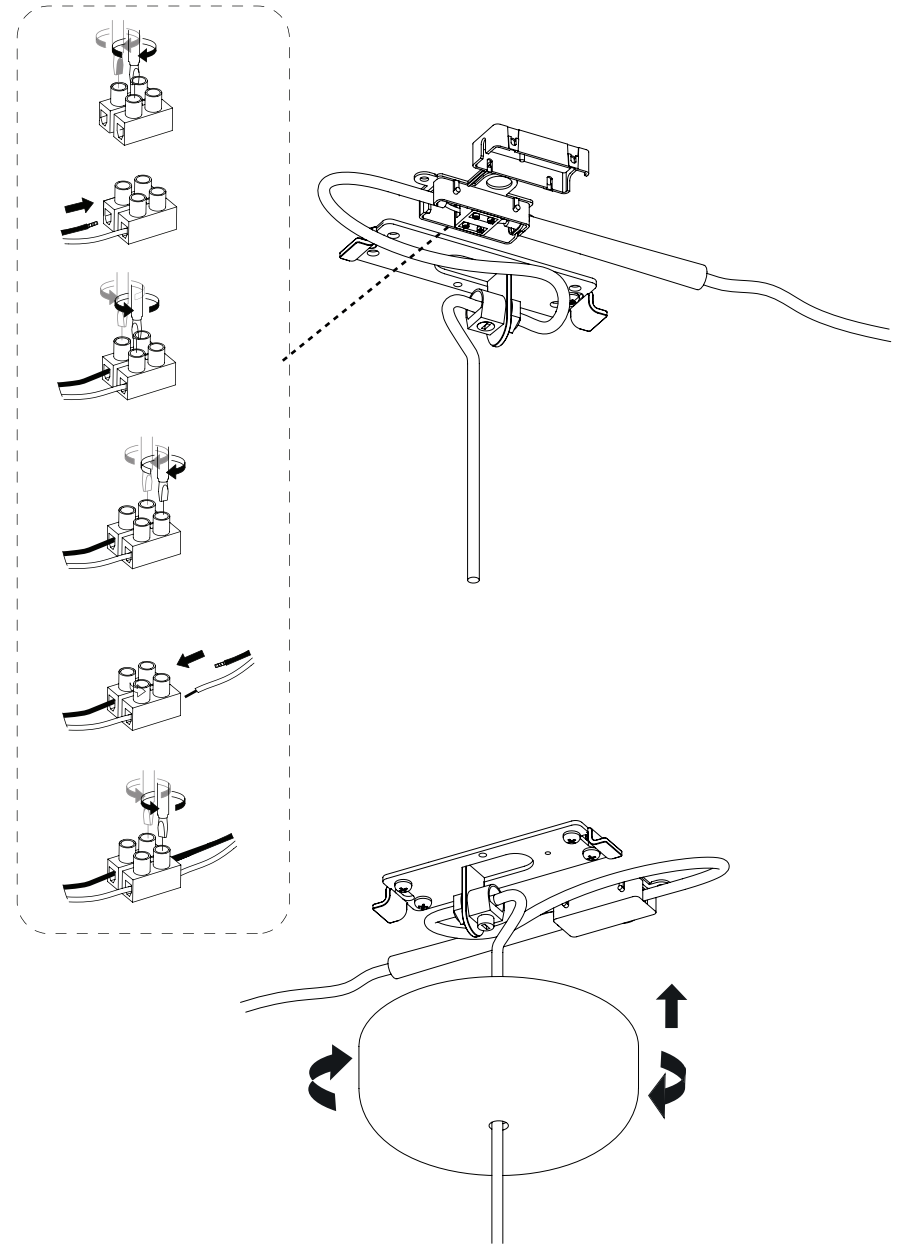

4

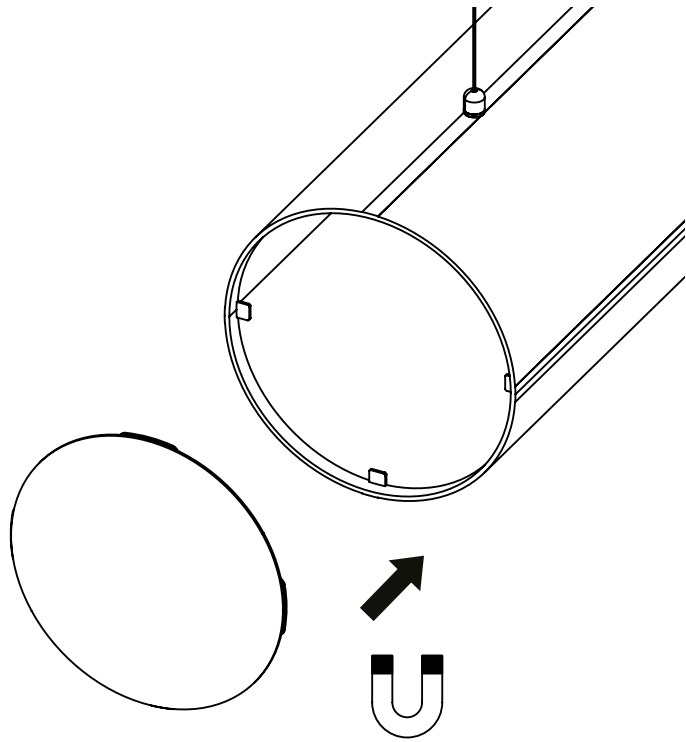

1

US version only

