

KIMONO suspension

Matteo Ugolini design

year 2012

TECHNICAL SHEET - SE635V-INT

STRUCTURE "A"

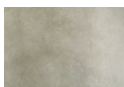
material	fiberglass	
colour	white	

CEILING CUP "E"

material	metal
colour	matt white

ELECTRICAL CABLE "C"

material	PCV	
colour	transparent	

SUSPENSION CABLE "F"

material	steel
----------	-------

ELECTRICAL SYSTEM

socket	E27
source	max 1x105w
energy class	from E to A++





PACKAGING

nr. of collis	1
net weight/kg	4,4
gross weight/kg	8
packaging/cm	63x63x67

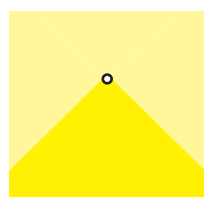
EMISSION OF LIGHT

one-directional



	direct
	filtered
	indirect
	none

CERTIFICATION

IEC	60598-1:2008
EN	60598-1:2008 + A11:2009



IP rate	IP20
bulb	not provided

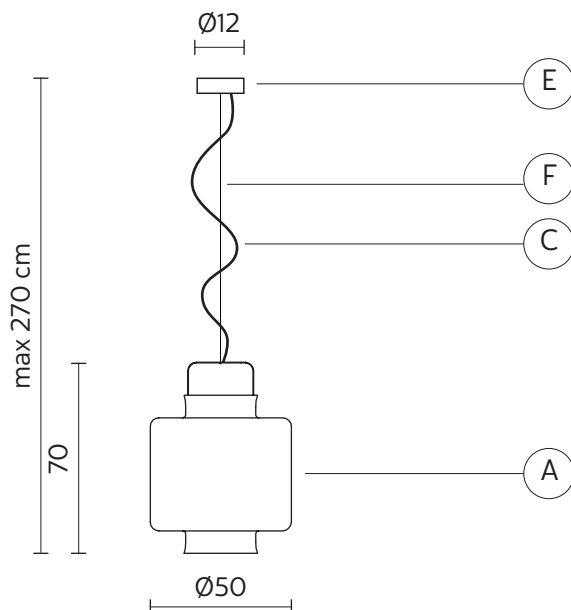

COLLECTION

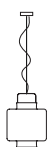

SE635V-EXT



SE636V-INT



SE636V-EXT