



NEWGARDEN



CREA TORS

of outdoor & indoor moments



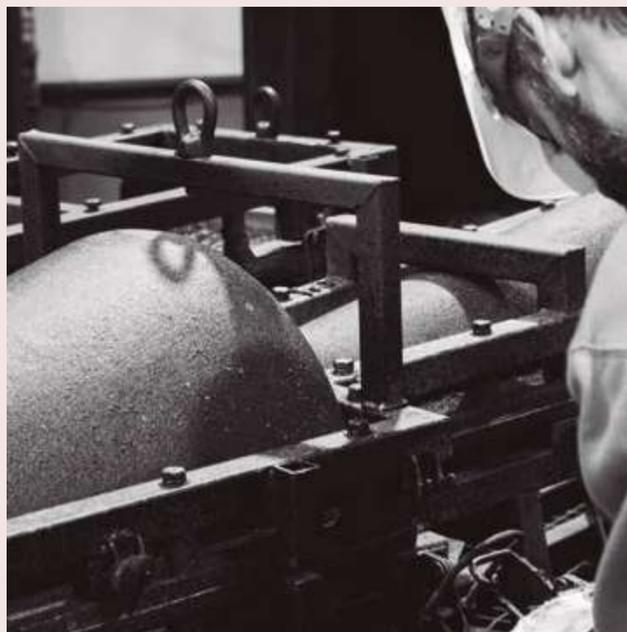
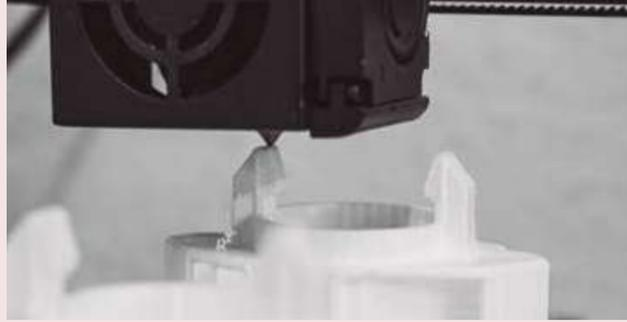

proud makers of the 'be happy' spirit



MANUFACTURERS & designers of memories

“ Light is the first element of design, without it, there is no colour, shape or texture. Light is the magic ingredient that makes or modifies a space. We are, therefore, facing one of the most important elements for the creation of memories and experiences.”

Thomas E. Farin & Benjamin Noriega.



The power of the sun is unimaginable. It is capable of generating life, inspiring our personality or changing our state of mind in seconds. At Newgarden we know about its power. That is why, since our beginnings, its energy has been the protagonist in our products. This is why we have ensured that the majority of our designs are available with a solar option.

*sun is
our energy*

❤️ 89

❤️ 92

**We recycle.
We reuse.
We reduce.**

Nature is our mother, and we love her as such she were our mother. Newgarden works every day to improve all our processes in order to protect and care for our environment. We are not content just with all of our products being recyclable so we have designed Gretita and Greta, two collections of lamps made exclusively from recycled materials.

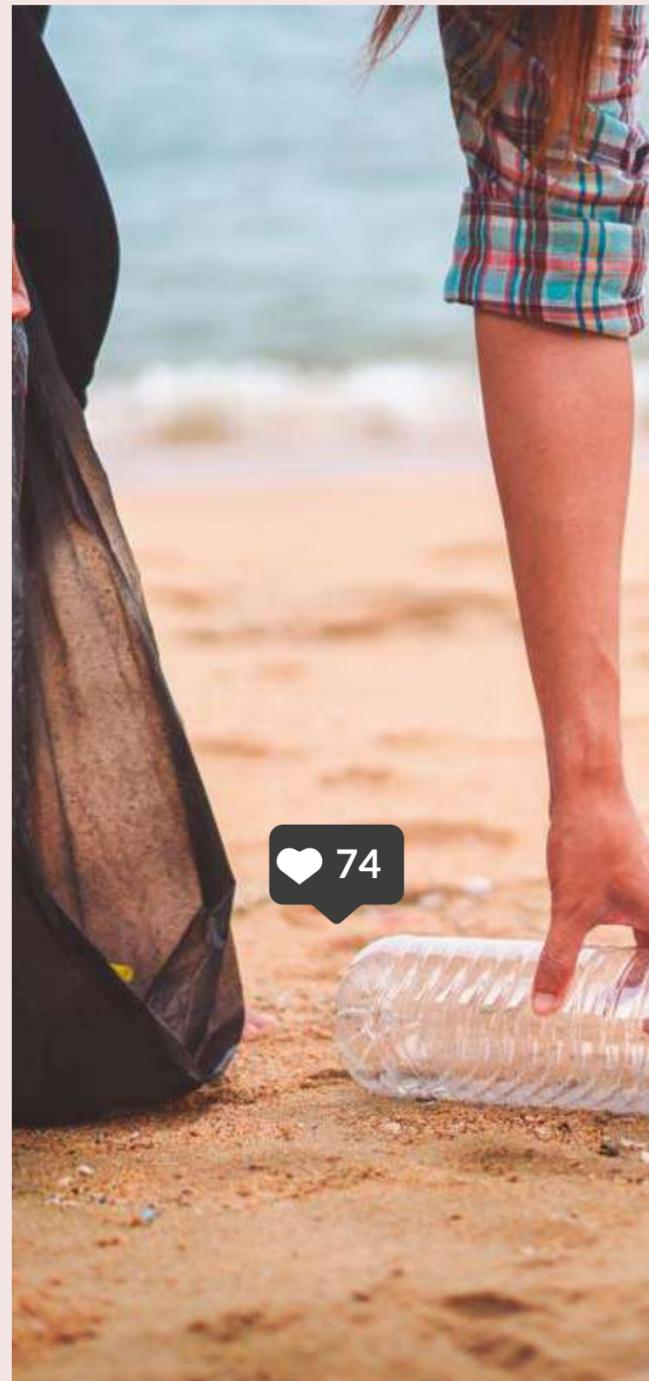

sustainability **stories.**

Nature Lovers.

ALL OUR PRODUCTS ARE 100% RECYCLABLE AND HAVE A LONG LIFE SPAN, HELPING TO REDUCE WASTE AND PROMOTING RESPONSIBLE CONSUMPTION. FOR EVERY LAMP IN THE GRETA OR GRETTA COLLECTION THAT WE MAKE, WE HELP TO GIVE A SECOND LIFE TO PLASTICS COLLECTED FROM SEAS AND OCEANS.

Handmade.

NATURAL FIBRES SUCH AS HEMP OR BAMBOO ARE WIDELY REPRESENTED IN OUR COLLECTION. BEING HANDMADE, THEY ARE ABLE TO TRANSPORT US TO NATURE AND TO THE MEDITERRANEAN JUST BY LOOKING AT THEM.

Think Local.

WE COLLABORATE WITH SPECIALISED LOCAL PRODUCERS WITHIN THEIR REGIONS - THIS HELPS THEIR ECONOMIES GROWTH AND SUPPORTS INFRASTRUCTURES DEVELOPMENT.

PRODUCTS

- (1) HIAMA (2) AURORA GARLAND (3) TARIDA SIT (4) NIZA 165
- (5) TARIDA TAB (6) SANTORINI (7) HORTENSIA 30
- (8) CHLOE 140 (9) RASA (10) SIROCO

holidays AT HOME



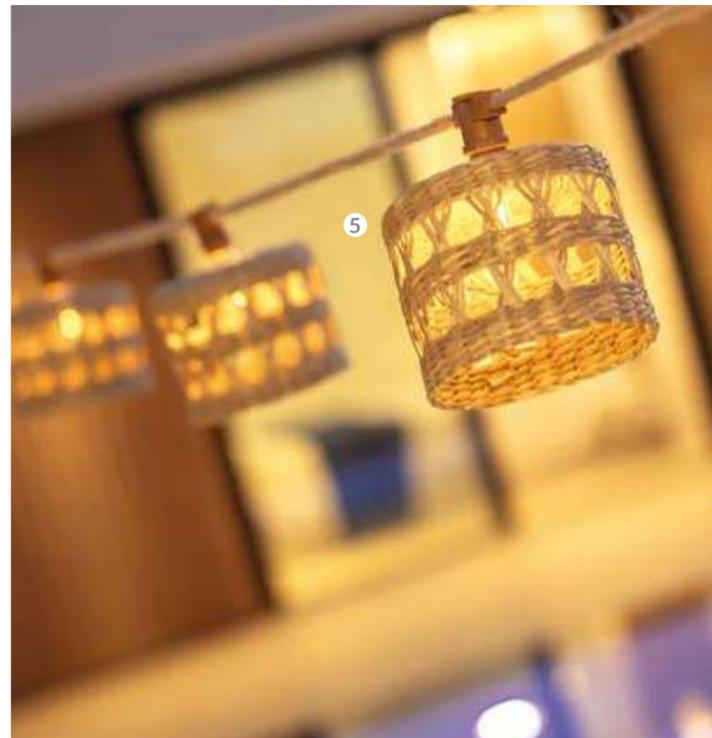
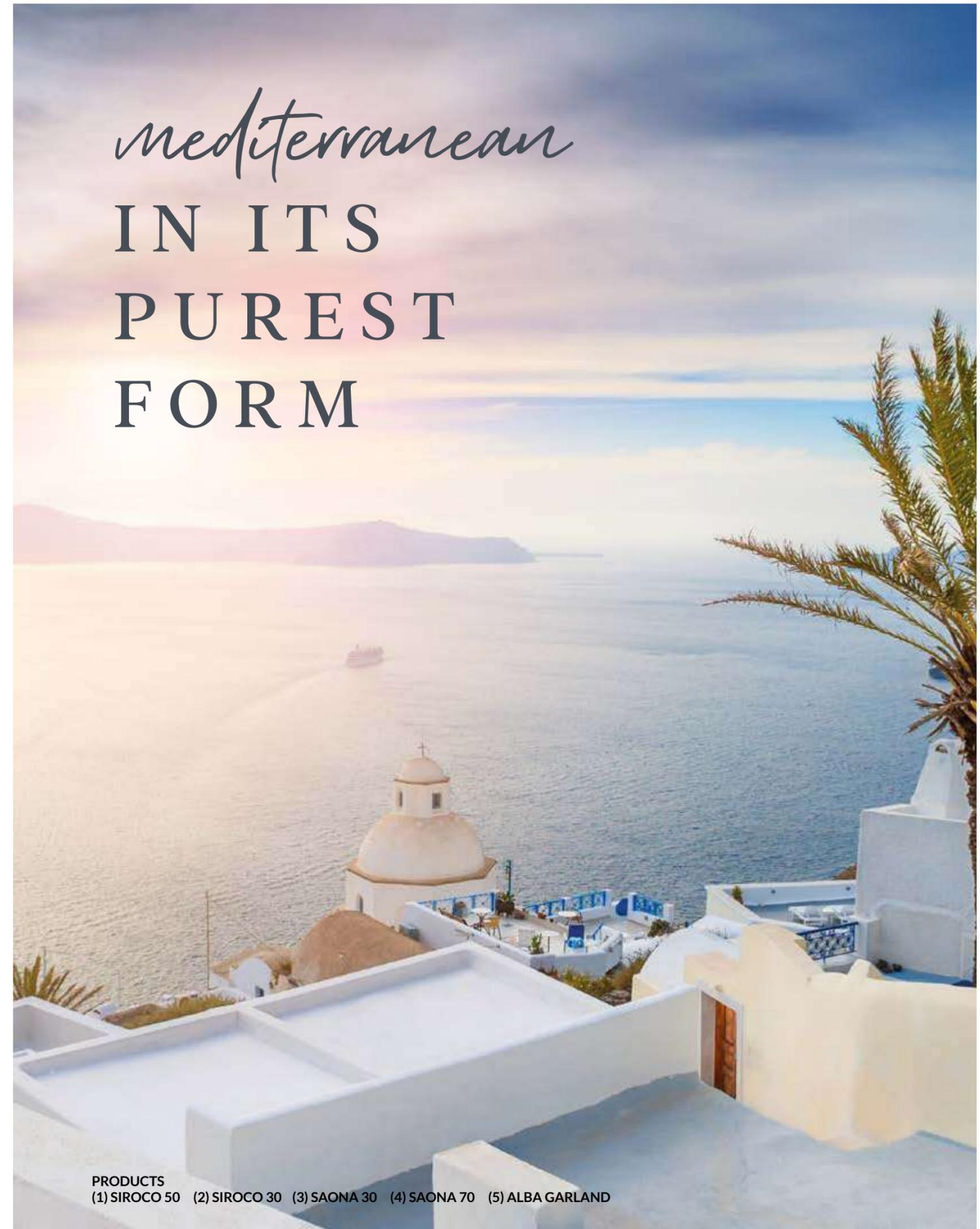

paradise MODE ON



- PRODUCTS
(1) BRUNA 80 (2) BULY 30 (3) TARIDA SIT ARMS (4) SAONA HANG (5) CALOBRA HANG
(6) NIZA 230 (7) SISINE HANG (8) SAONA 70 (9) BOSSA 30 (10) TARIDA TAB
(11) AURORA GARLAND (12) LOLA 110 (13) FITY100 (14) FITY 160 (15) NORAI SLIM 35



Light &
Deco.



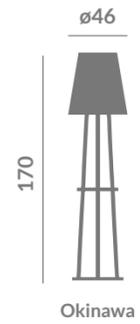

Okinawa.

Options

Light | Solar & battery 

+ Info P.202



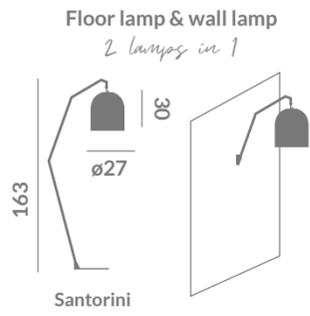

Options
Light | Battery 
+ Info P.202



Santorini.



Niza 165.

Options

Light



Battery



+ Info P.201

Floor lamp & wall lamp

2 lamps in 1

73

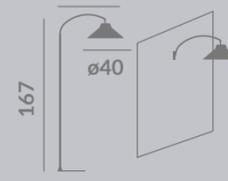

Niza



Rechargeable Bulb
(Battery Version)



Niza 230.

Floor lamp & wall lamp
2 lamps in 1+

Options

Light | ✕ Battery

+ Info P. 201

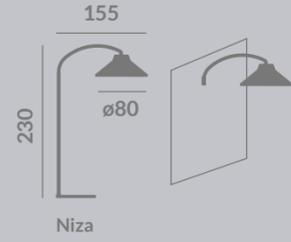

Rechargeable Bulb
(Battery Version)

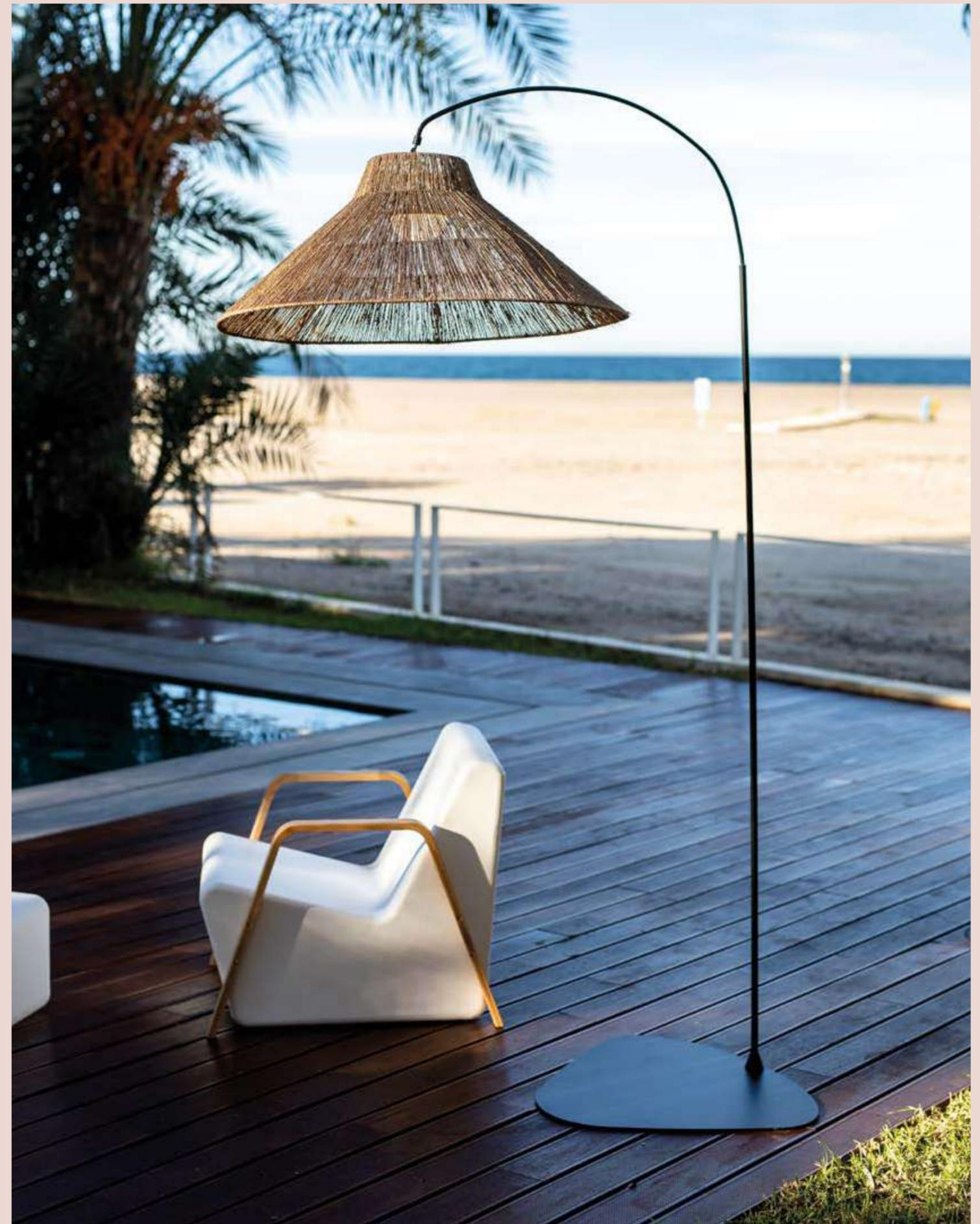



Amalfi.



Options
Light

Battery 

+ Info P. 198

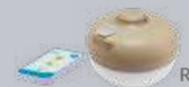

Rechargeable Bulb
(Battery Version)

Lola Slim.

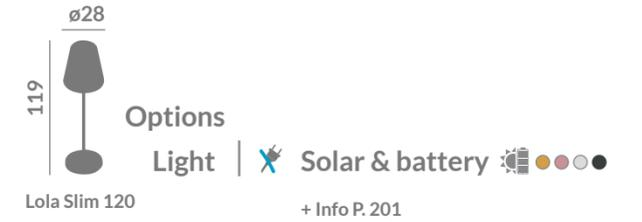

LOLA SLIM 120





Options

Light | Solar & battery

+ Info P. 199



Chloe Plant.

Chloe 140.



Options

Light



Cable



Solar & battery

+ Info P. 198

Rocket.

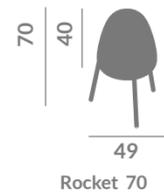

Options

- Light | Cable
 Solar & battery
- + Info P. 202



Options

- Light | Cable
 Solar & battery
- + Info P. 202

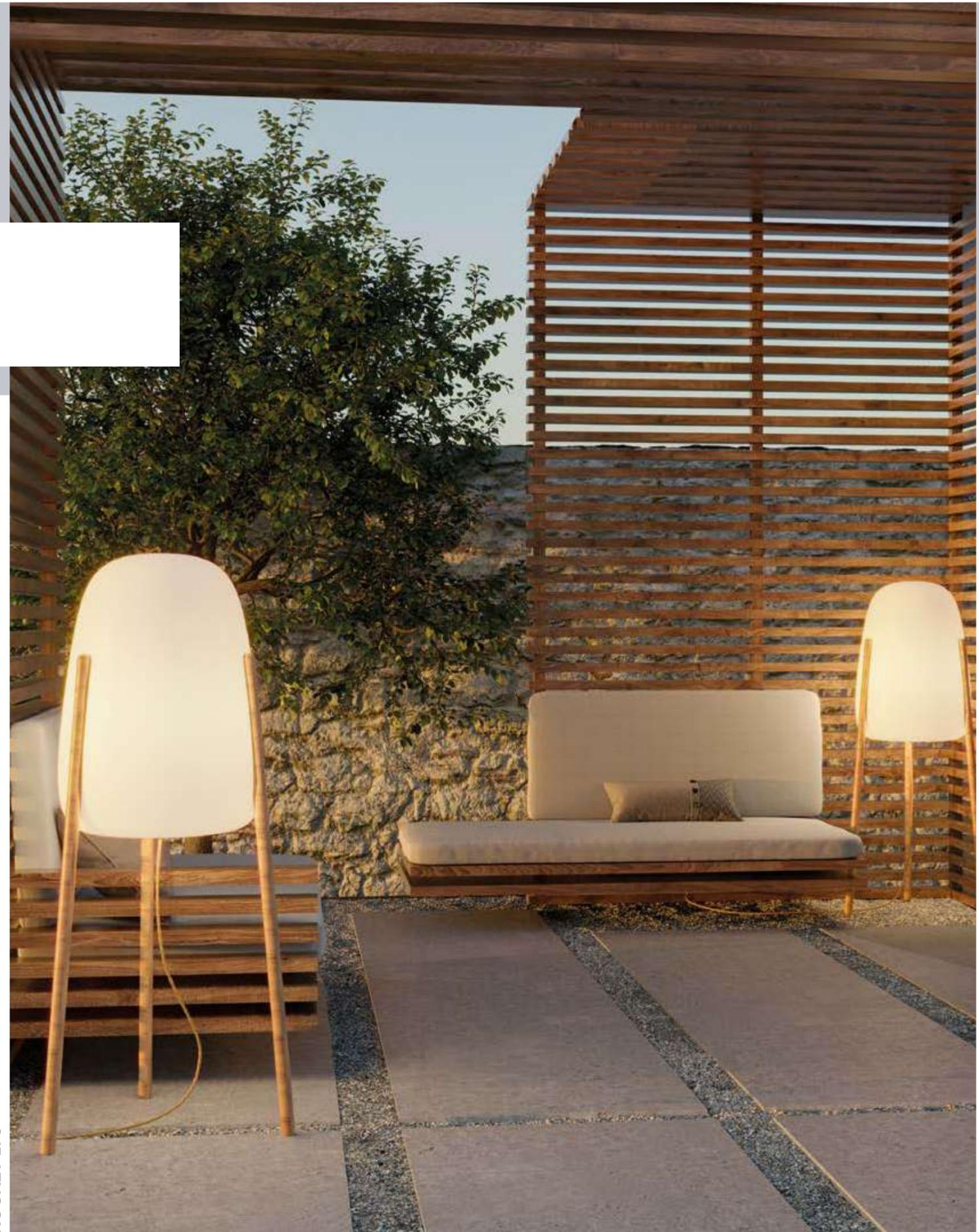

ROCKET 175



FITY 100

Fity.



Options

Light



Cable

Battery 

+ Info P. 199





Pancho.

61x43

139



Pancho

Options
Light

Cable
 Battery

+ Info P. 202



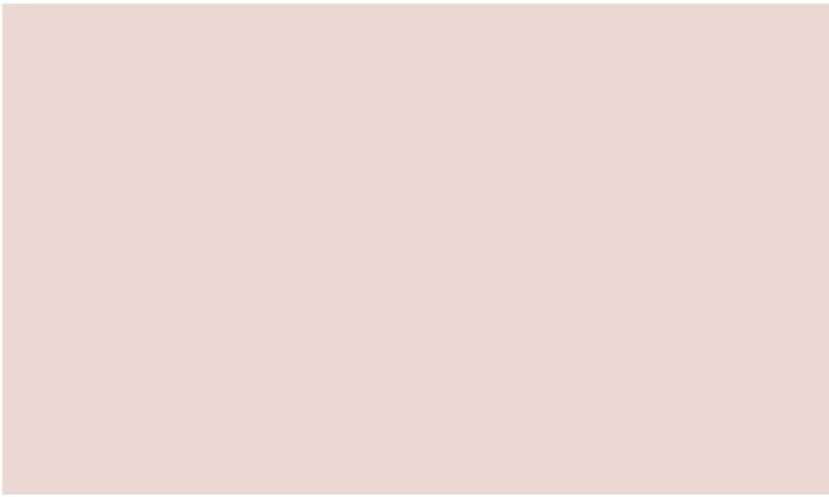

LOLA 110/165

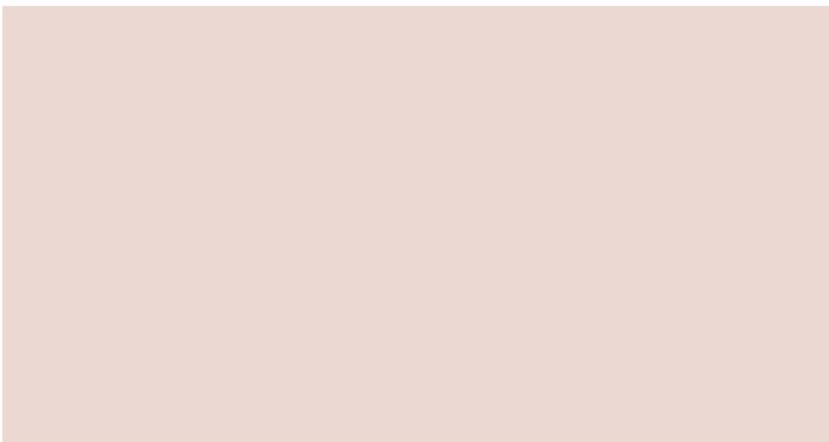

LOLA 200



LOLA 165

Lola.

Options

Light | Cable | Battery

+ Info P. 200, 201





CARMEN 165

Carmen.



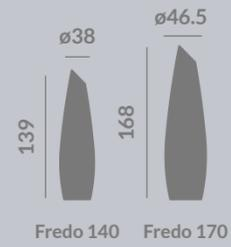

Fredo.

Options

- Light
- Cable
- Battery

+ Info P. 199



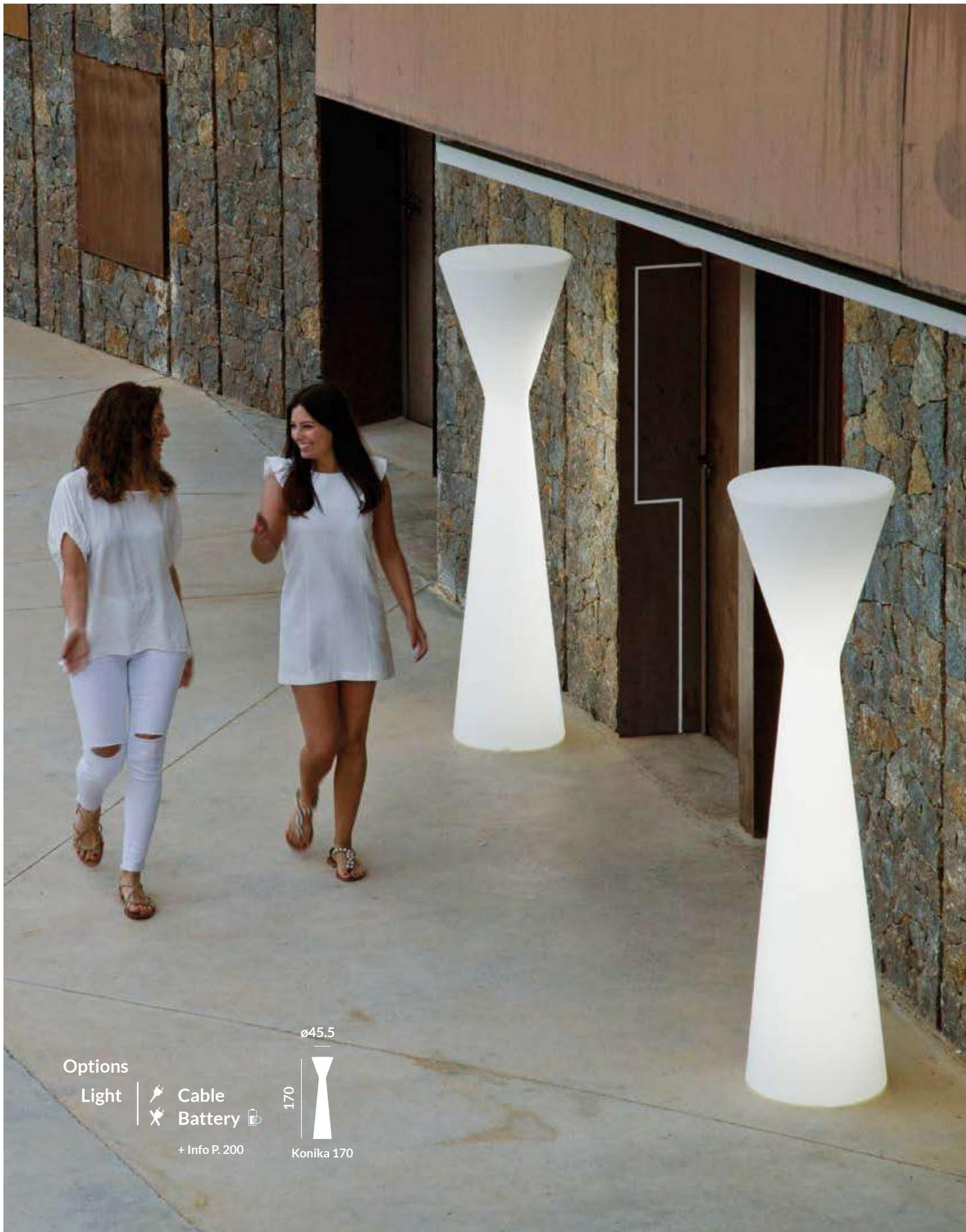

Options

Light



Cable



Battery



+ Info P. 200

ø45.5



Konika 170



Konika.

Options
Light

Cable
 Battery

+ Info P. 200

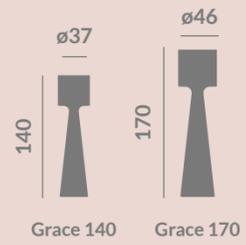

GRACE 170/140



Grace.

Siroco.

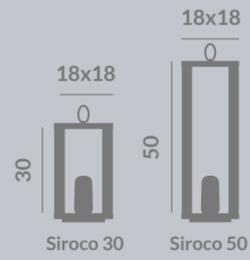

Options

Light | ✕ Battery

+ Info P. 204, 205



Hياما.

120
ø8,2
Hياما

Options

Light | Solar

+ Info P. 216



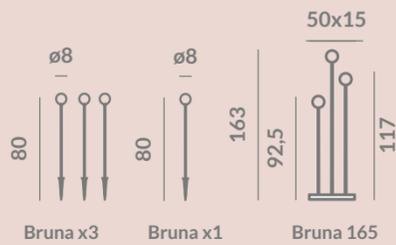

Options
Light

- Cable ●
- Solar & battery ●

+ Info P. 215, 203

Bruna.



BRUNA 165



BRUNA x3



BRUNA x1



Options
Light |  Solar   

+ Info P. 216



Gretita

Gretita.

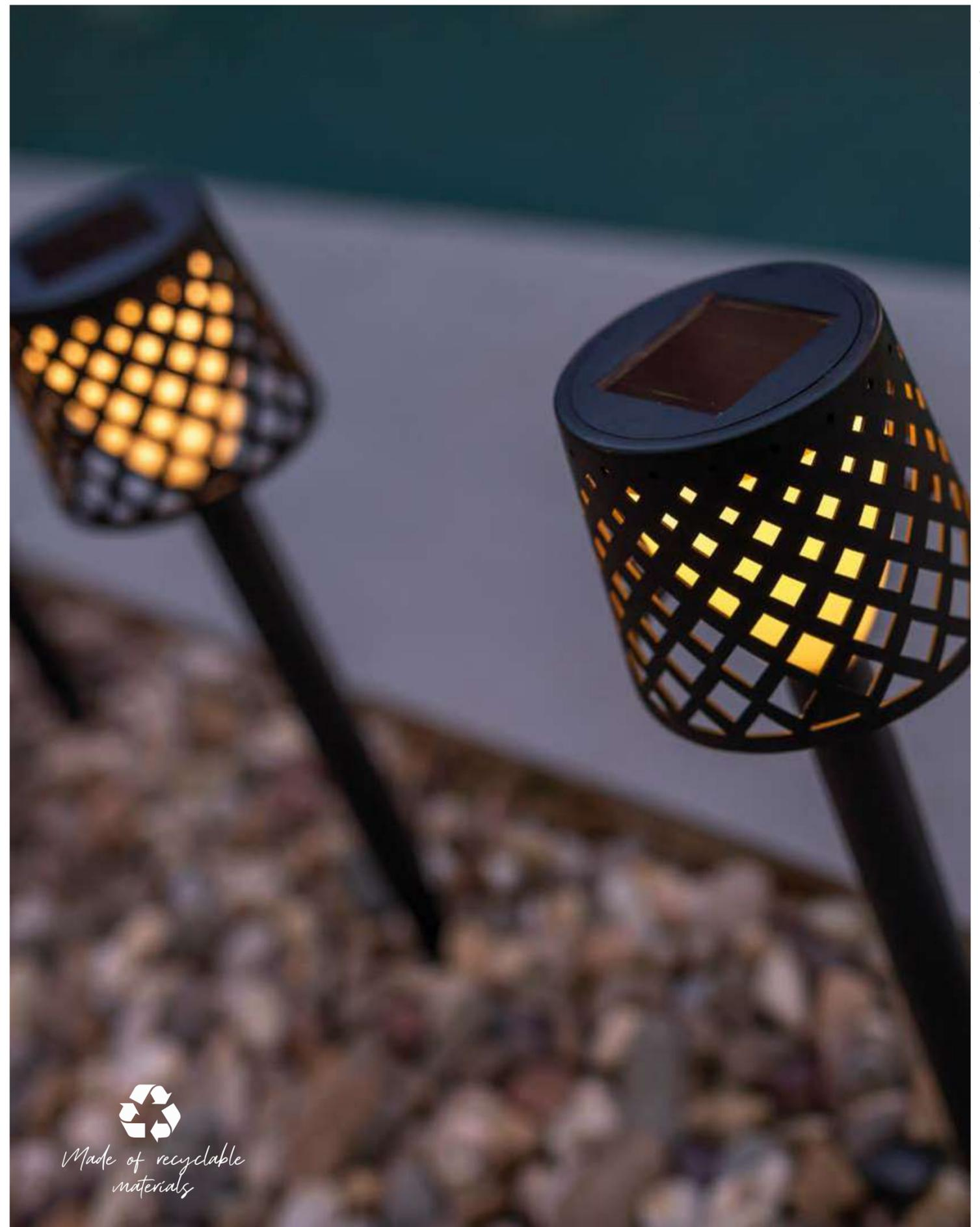



Made of recyclable
materials

Greta.

Made of recyclable
materials

Options

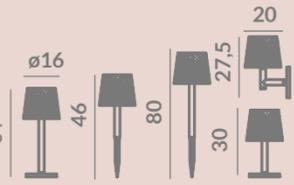
Light |  Solar & battery
+ Info P. 216



Stamps incl



Kaktus.



Options
Light

Cable
 Battery

+ Info P. 204

44x31

100

Kaktus

Options
Light

Cable
 Battery

+ Info P. 203

59x36.5

65

Balans



Balans.



Options
Light

Cable
 Battery

+ Info P. 203

25x29

40

70

43x49

Goa 40

Goa 70



Options

Light

- Cable
- Battery 

+ Info P. 213, 204



Rechargeable Bulb
(Battery Version)



Saona.



Options

Light

- Cable
- Battery

+ Info P. 213, 205



Sisine.



Rechargeable Bulb
(Battery Version)



Light & Deco Table lamp ~ Bossa / Chloe



Options
Light | ✕ Battery  19 |  ø9
+ Info P. 211 Candy

Candy.



Norai slim

35 | $\varnothing 11,5$

Options
Light |  Battery    

Norai Slim 35 | + Info P. 213





Enoki.



Options

Light



Battery



+ Info P.211

LOLA 45



Options

Light



Cable



Battery

+ Info P.212

LOLA 30



LOLA 20



Lola.

Lola slim

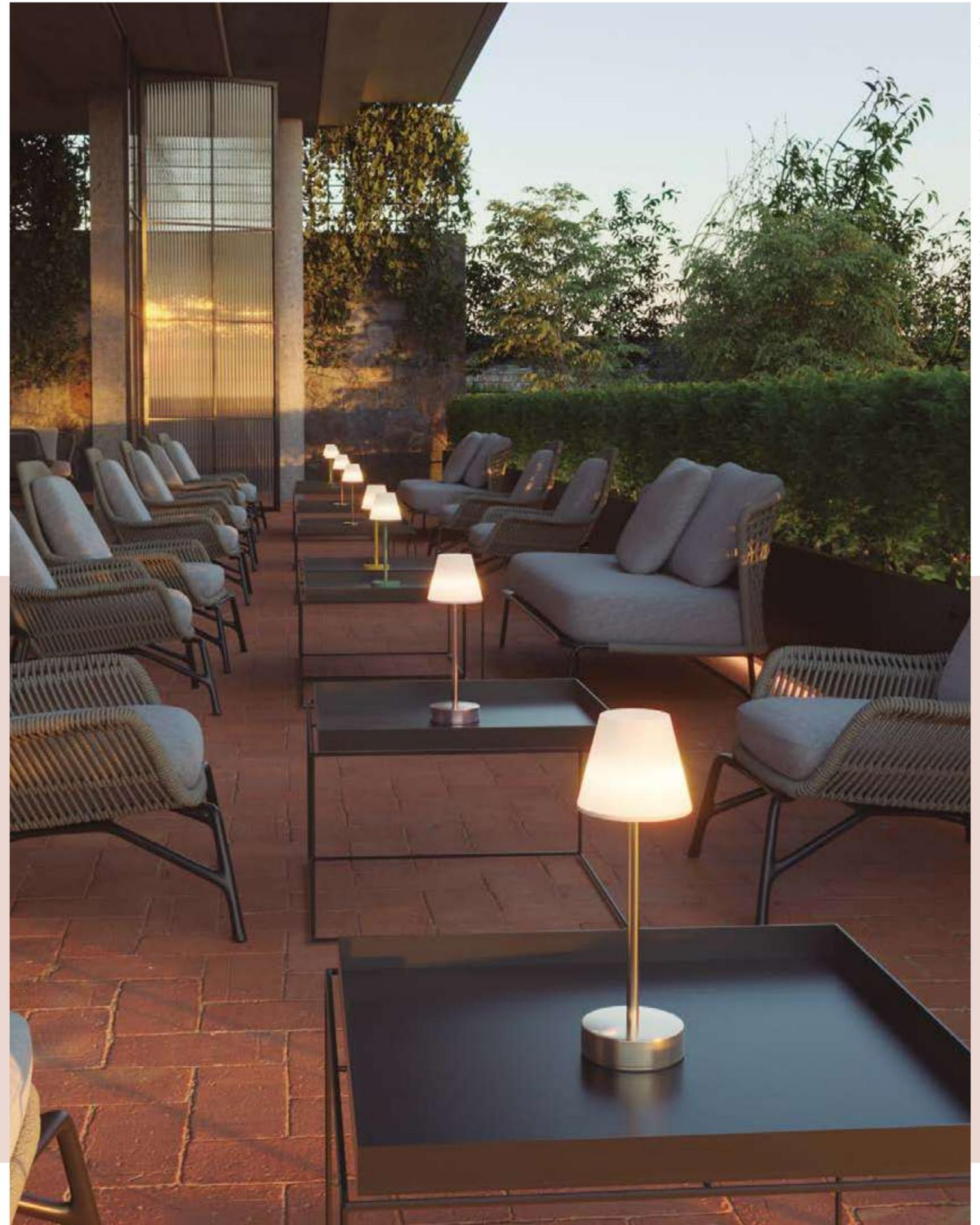

11
32
Options
Light | Battery ●●●●●●●●
Lola Slim 30 + Info P. 212



Lola Lux.



Lola lux

Options

Light



Battery



+ Info P. 212





Aurora.



Alba.

Options

Light Cable Solar & battery

+ Info P. 205 

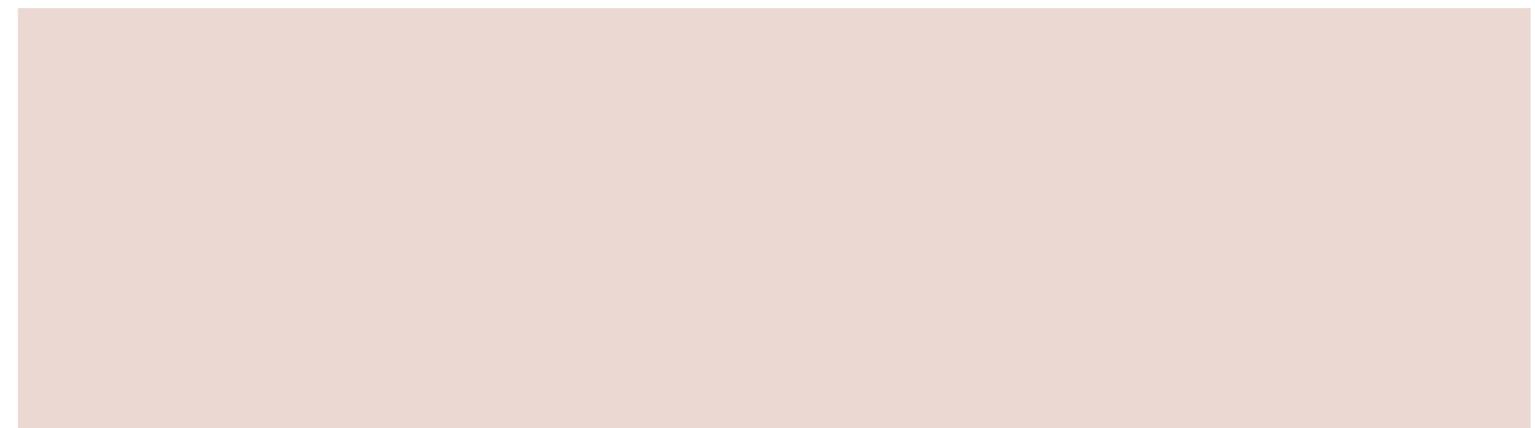

Options

Light Cable Solar & battery

+ Info P. 205 

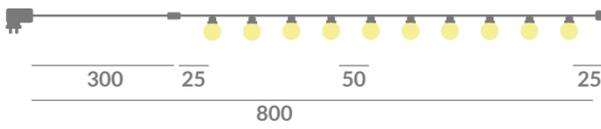

- Options
- Light
 - Cable
 - Solar & battery
- + Info P. 206
- 

Bruna.



Luceo.

Options

Light



Cable

+ Info P.206



Luceo 3x2



Luceo 6x3

Options

Light



Cable



Solar & battery



+ Info P.206

Stella



Stella.



Chelsea

Options
Light | Cable
+ Info P. 206

300 25 50 25
800

Chelsea

Chelsea.



Allegra

Options
Light | Cable ○●●●
+ Info P. 205

300 25 50 25
500

Allegra

Allegra.

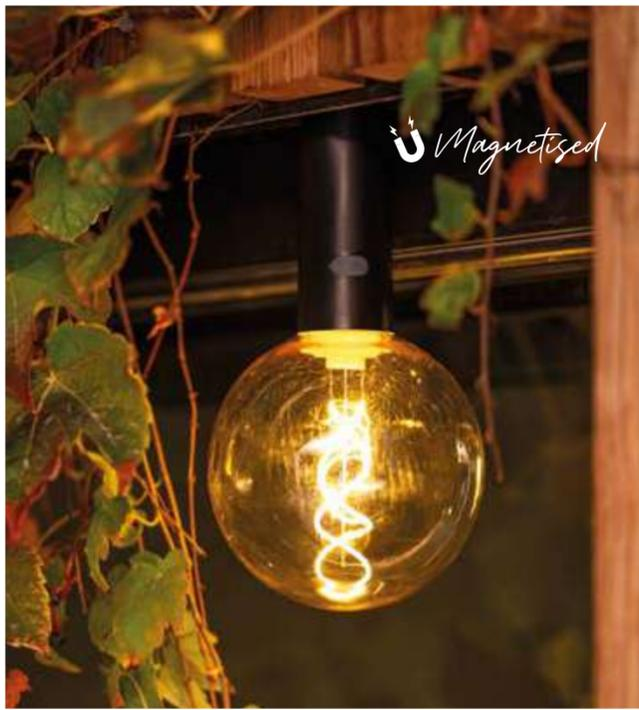

Magnetised



without cables



Made of recyclable materials



Edy.

Options

Light



Battery



+ Info P. 208



Edy G125



Edy A100





Elba.

Options

Light | Battery 

Plants included

+ Info P. 208

ø38,3



10



Elba 39

ø58,3



15



Elba 59



Rechargeable Bulb
(Battery Version)



Simona.



Options
Light Solar & battery + Info P.210

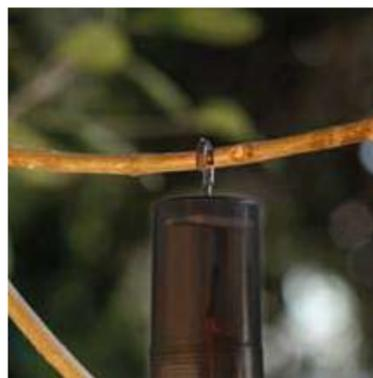

without cables

Options
Light Solar & battery + Info P.208

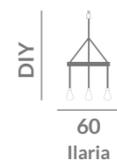

Ilaria.



Chiara.



Options
Light

Solar & battery

+ Info P. 207

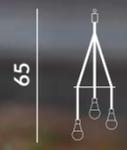

65
ø17,5
Chiara



without cables



Positano.



Options
Light

Battery

+ Info P. 209

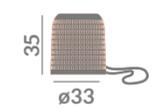

35
ø33
Positano



Rechargeable Bulb
(Battery Version)



without cables



Benirrás.

Options

Light



Battery



+ Info P. 207

35



Benirrás



Rechargeable Bulb
(Battery Version)

Saona.

Options

Light



Battery



+ Info P. 210

49



ø31
Saona



Rechargeable Bulb
(Battery Version)

Light & Deco ~ Portable hang lamps ~ Benirrás / Saona

Nature hang.

without cables

Calobra.

Reona.

Bossa.

Sisine.



Options
Light | Battery
+ Info P. 207

19

ø38
Calobra

Options
Light | Battery
+ Info P. 210

30,5

ø43,5
Reona

Options
Light | Battery
+ Info P. 207

22

ø35
Bossa

Options
Light | Battery
+ Info P. 210

30,5

ø40
Sisine

Pianeta.

Options

Light

Cable
Battery

+ Info P. 209

ø25



Pianeta 25

ø35



Pianeta 35

ø45



Pianeta 45



Candela.

Options
 Light | Battery
 + Info P. 203

29 | ø20
 Candela

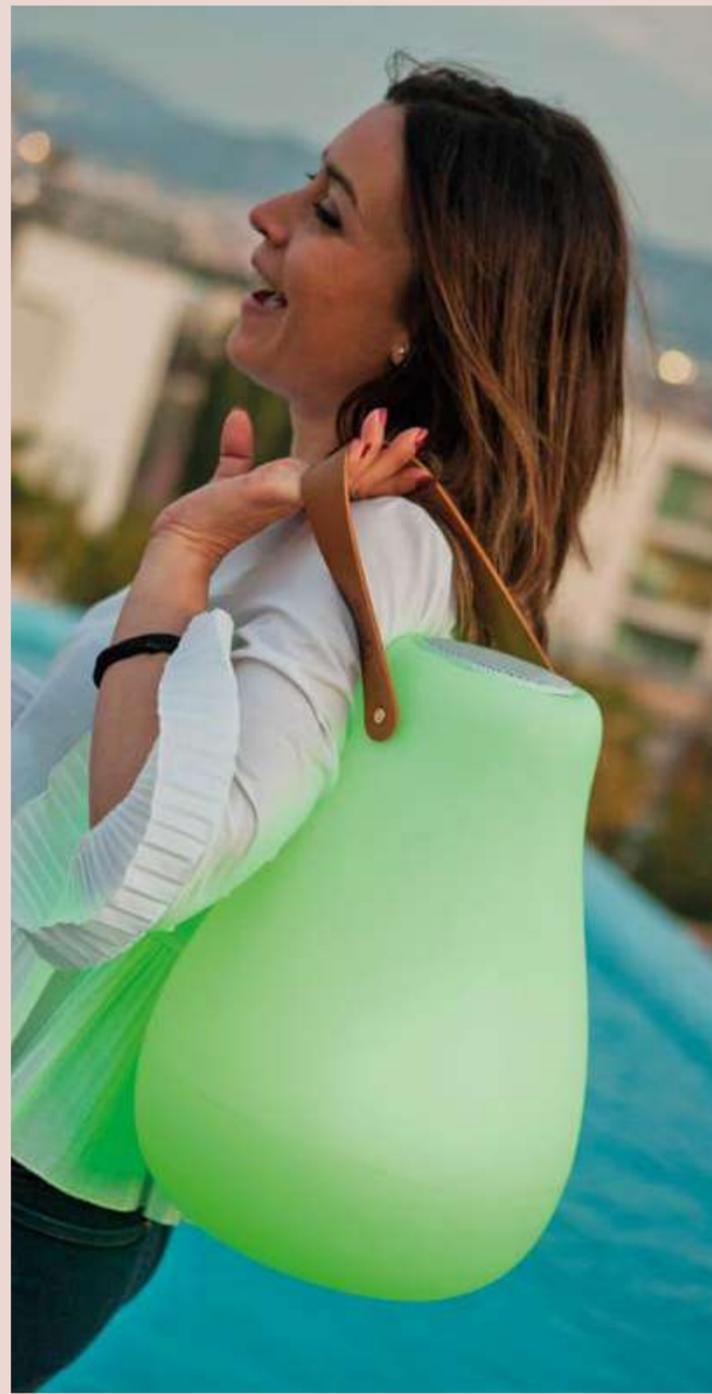

Kurby.

Options
 Light | Play light&music Solar & battery
 + Info P. 214, 204

37 | ø27.5
 Kurby



Nómada.

Options
 Light | Play light&music Solar & battery
 + Info P. 214, 204

30 | ø19
 Nómada

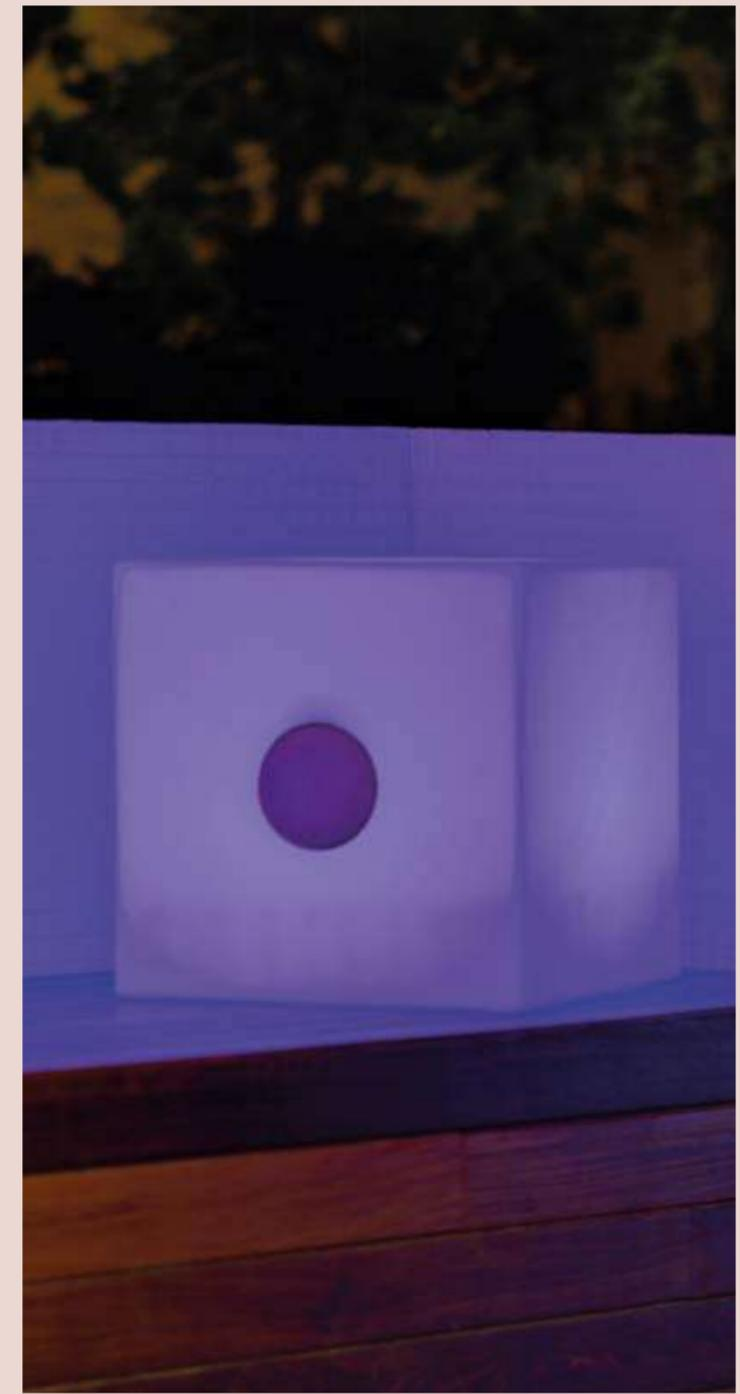

Cuby.

Options
 Light | Play light&music
 + Info P. 214

43 | 43x43
 Cuby 45

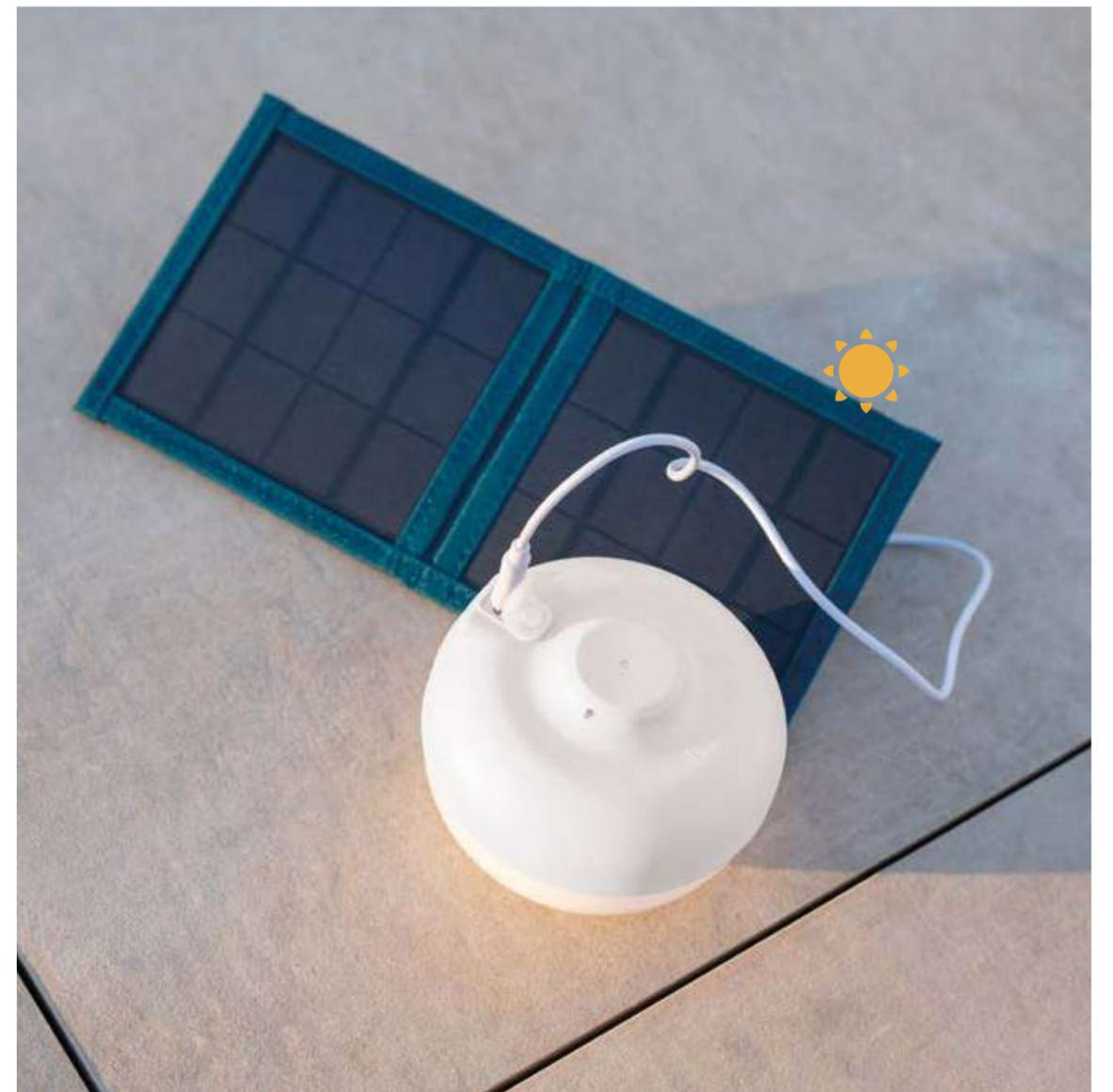

Cherry.

Options

Light | 

Battery 

Solar & battery 

+ Info P. 215

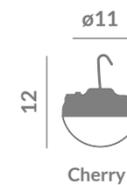

3bulbs in 1



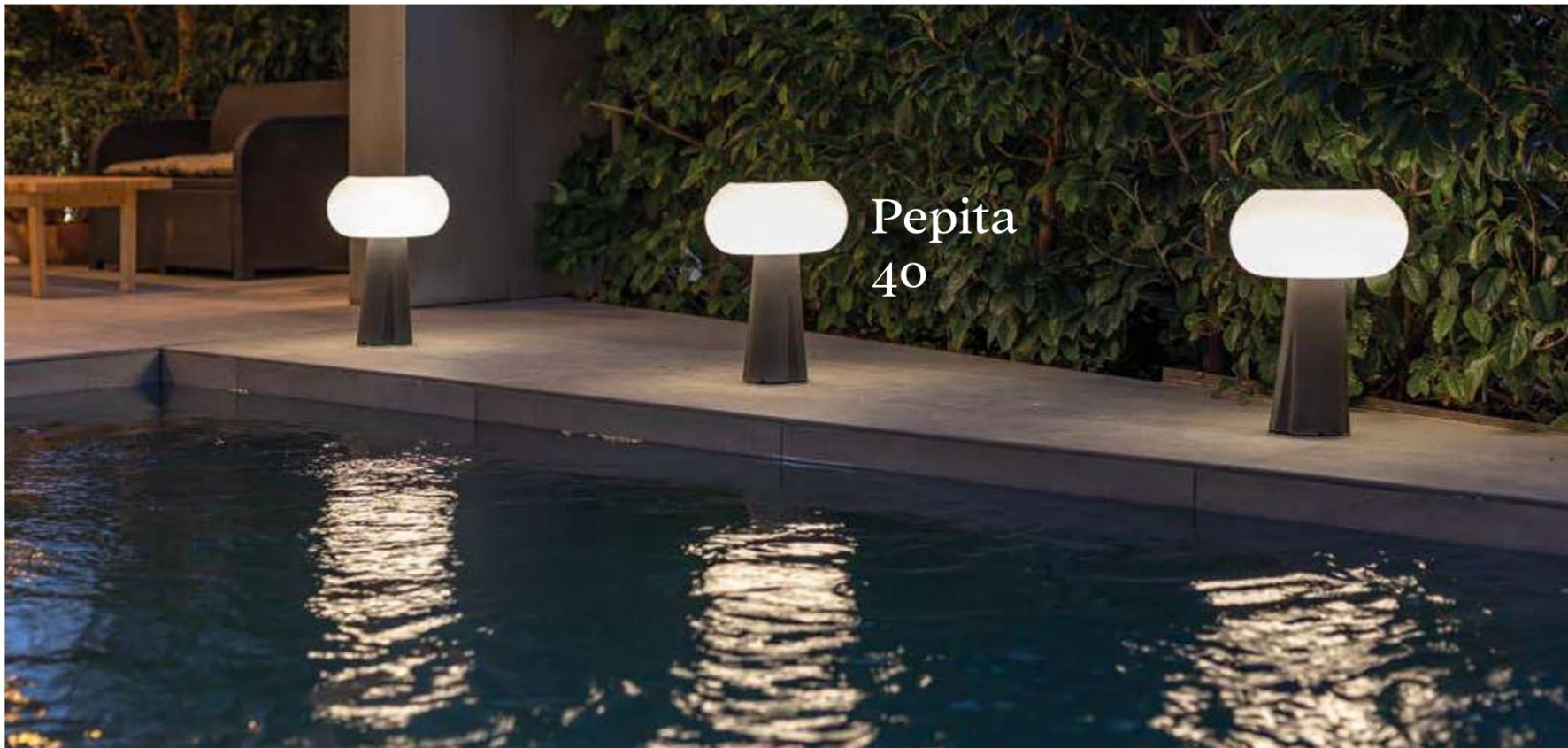

Options
Light | Solar & battery  + Info P. 217

		
Pepita 215	Pepita 40	Pepita wall

Hybrid lamp



Paquita wall

Paquita 215

Paquita 40

Options
Light

Solar ☀️

+ Info P. 216, 217



Paquita 215



Paquita 40



Paquita wall

Paquita.

Wally.



Made of recyclable materials



Options
Light



+ Info P. 218, 219



Options
Light



+ Info P. 219

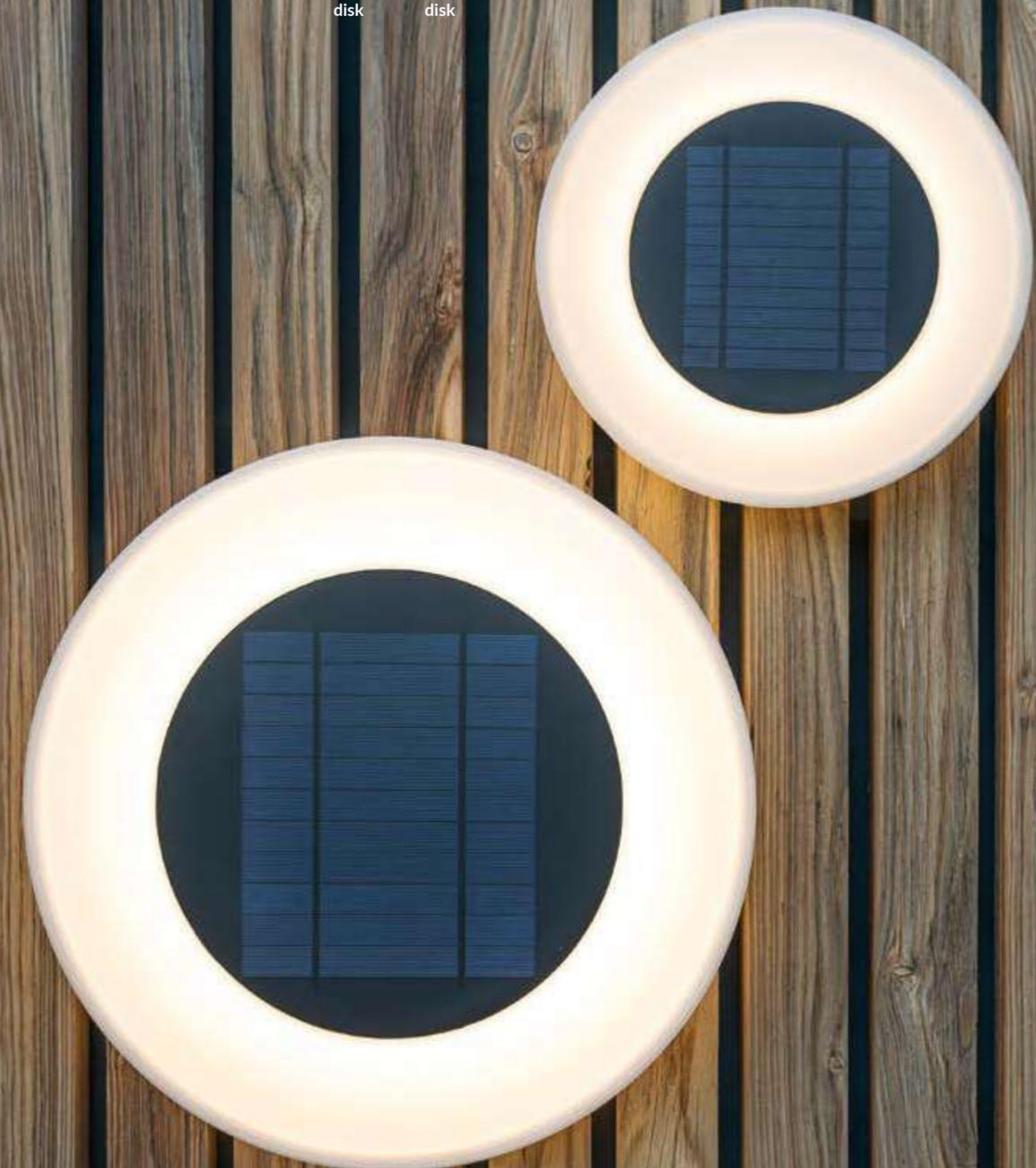



Sisine.



Bossa.



Rechargeable Bulb
(Battery Version)



Sisine Wall



Bossa Wall



Saona Wall

Options

Light | Battery

+ Info P. 218, 214



Saona.





Claudy.



Petra.



Lola wall.



Buly wall.

Light & Deco - Functional Petra / Claudy / Lola / Buly

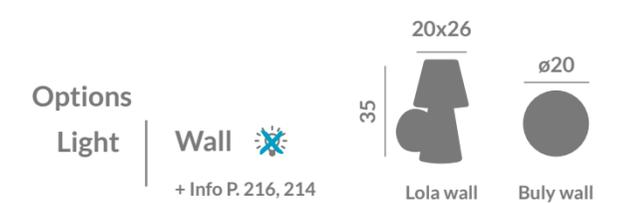
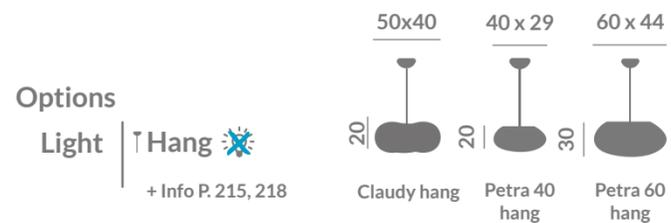

Options

Light

- Cable
- Solar & battery
- Floating
- Solar

+ Info P. 220, 221

17	ø20	ø30	ø40	ø50	ø60	ø78
	26.5	35	44	55	69	
Buly 20	Buly 30	Buly 40	Buly 50	Buly 60	Buly 80	

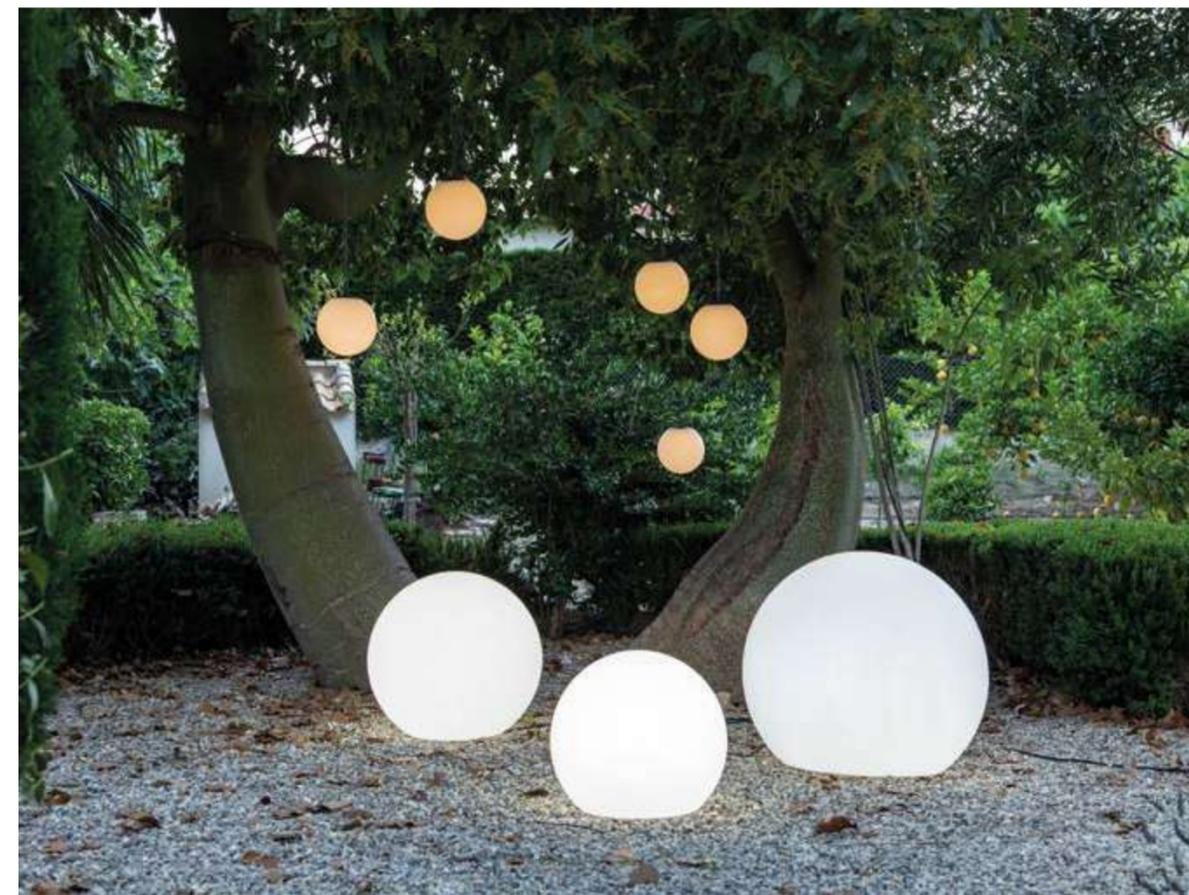

Buly.

Petra.

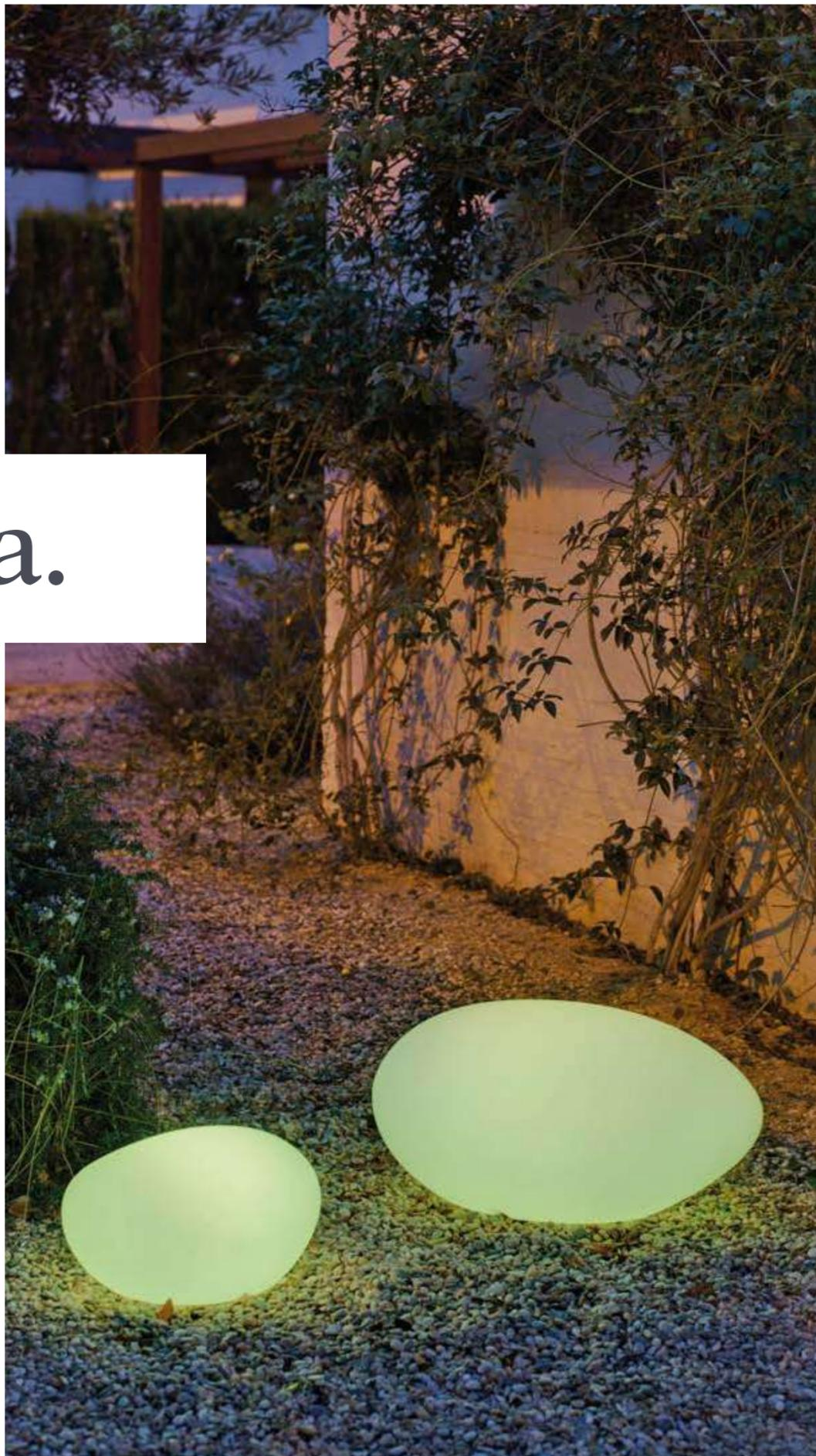

Options

- Light
- Cable
- Solar & battery
- Solar

+ Info P. 222

40 x 29	60 x 44
20	30
Petra 40	Petra 60



Cuby.

Options

- Light
- Cable
- Solar & battery

+ Info P. 221, 222

20x20	32x32	40x40	43x43	43x43
20	32	40	43	53
Cuby 20	Cuby 32	Cuby 40	Cuby 45	Cuby 53



Winter &
Christmas.



INDOOR COLLECTION

+ Ask us and discover our complete Indoor Collection.
Catalogue available.

PRODUCTS

(1) BULY INDOOR (2) AMALFI 80 HANG INDOOR
(3) SAONA INDOOR (4) LOLA SLIM 30
(5) SAONA HANG INDOOR (6) LOLA SLIM 180
(7) SISINE 70 INDOOR

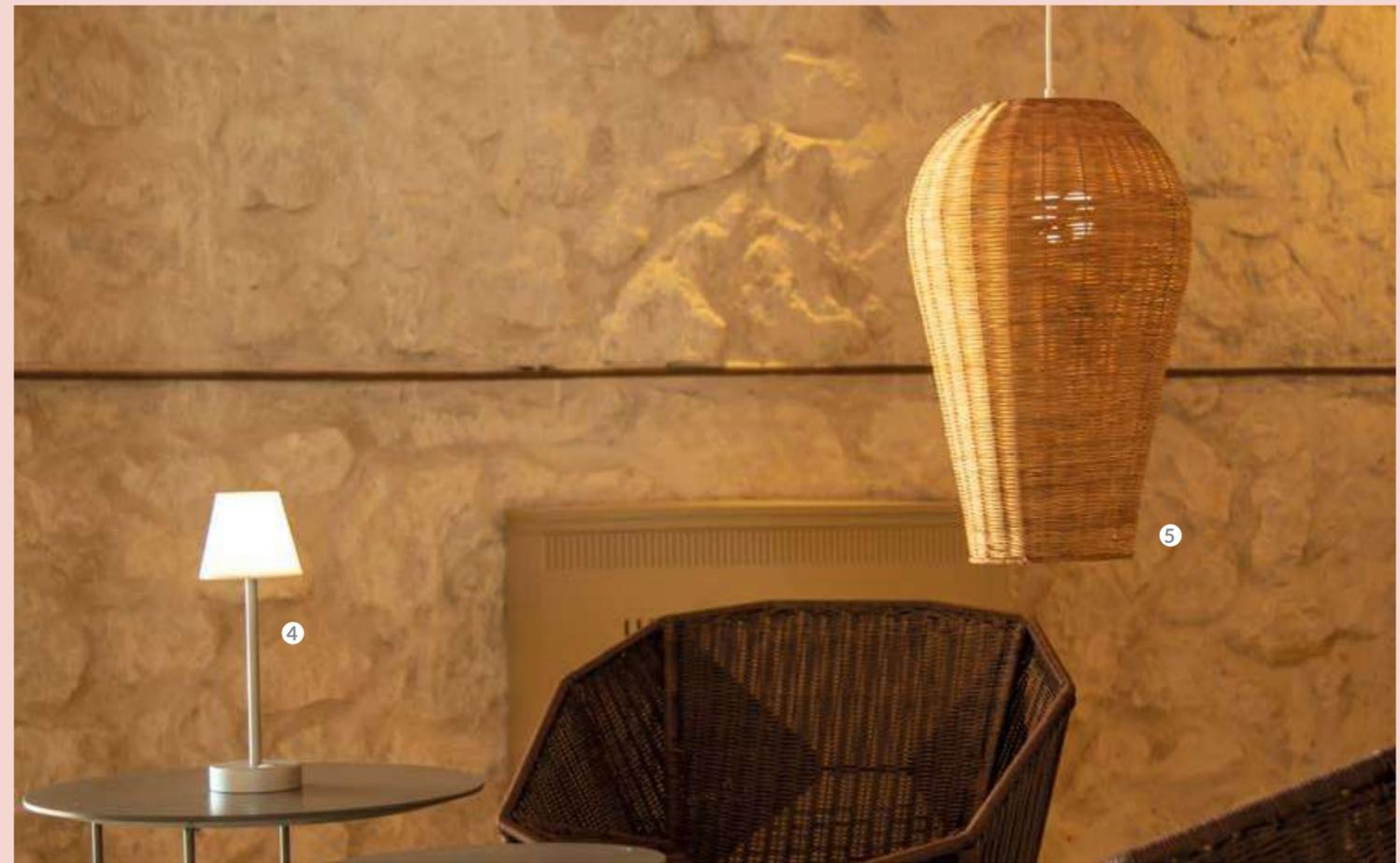
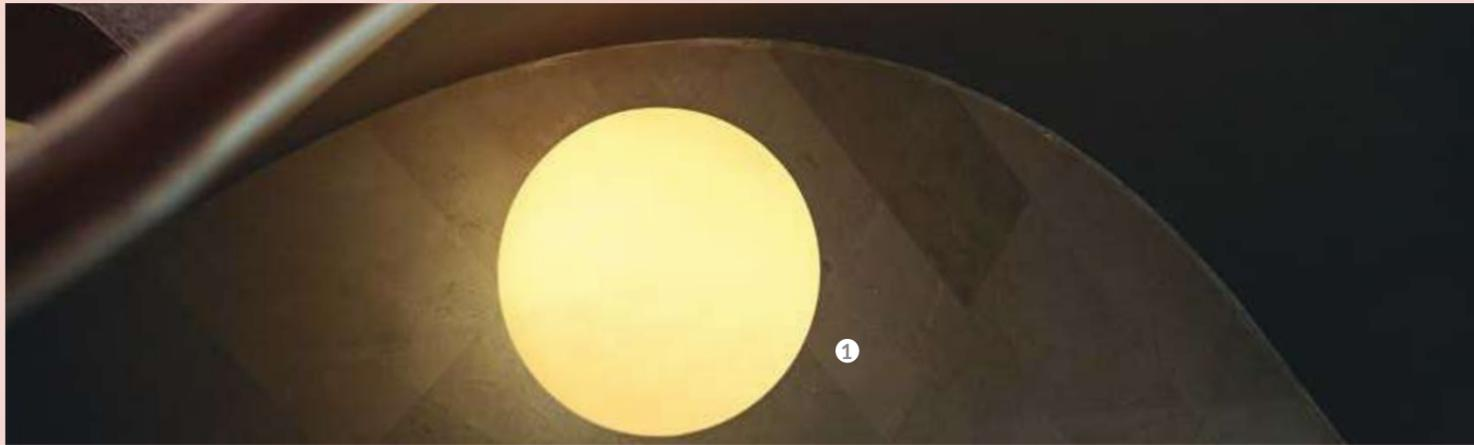

CHRISTMAS COLLECTION

+ Ask us and discover our complete Christmas Collection.
Catalogue available.

PRODUCTS

(1) PALLINA GARLAND (2) BIANCA GARLAND
(3) LUA (4) GIFTY FAMILY (5) SISINE STAR 60
(6) PINUS FAMILY



Furniture.

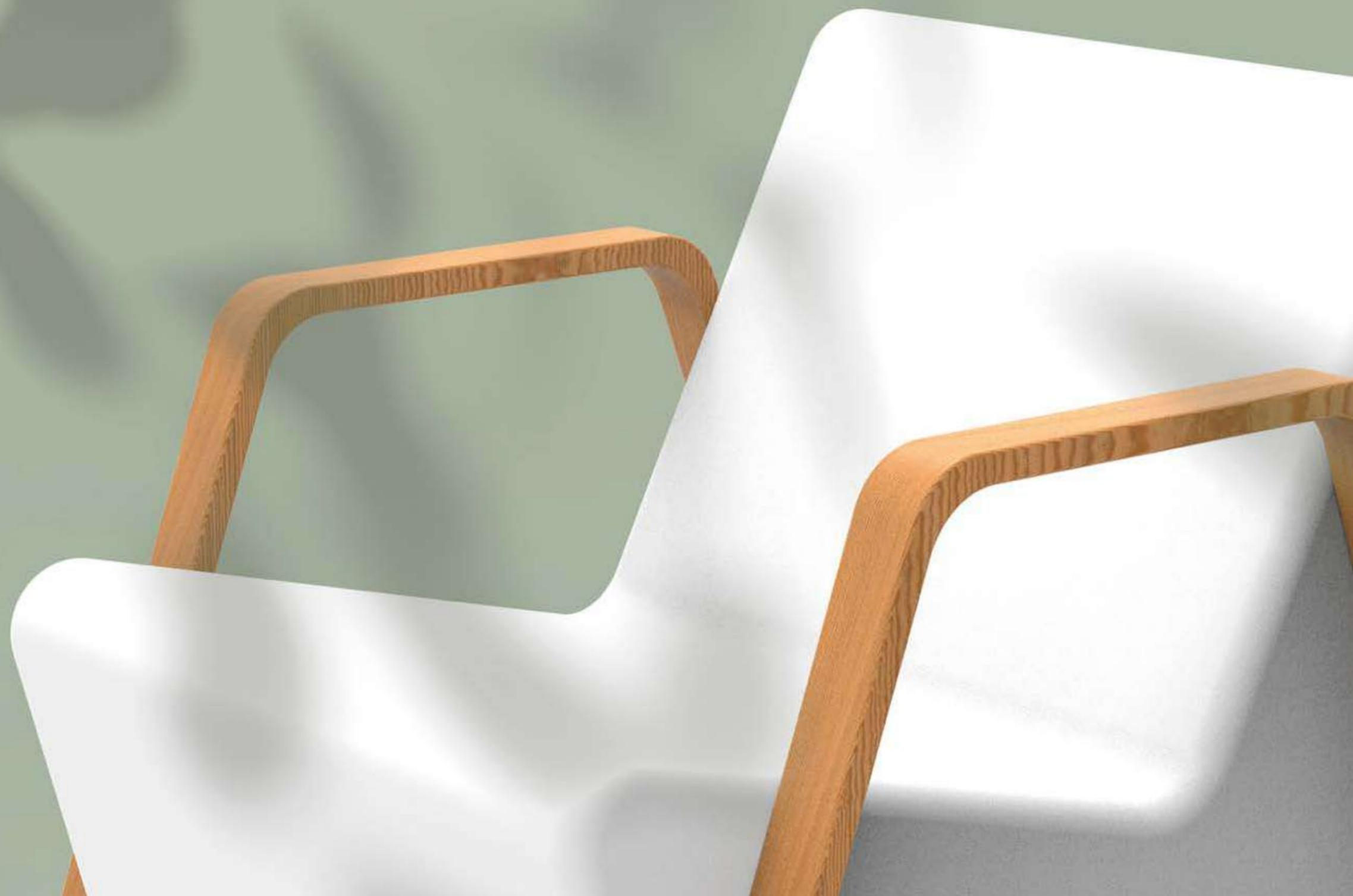

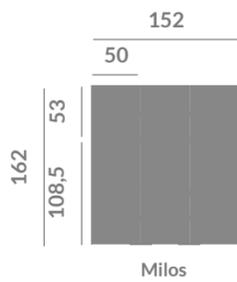

Options
Nature

+ Info P. 227
Lights and plants
not included

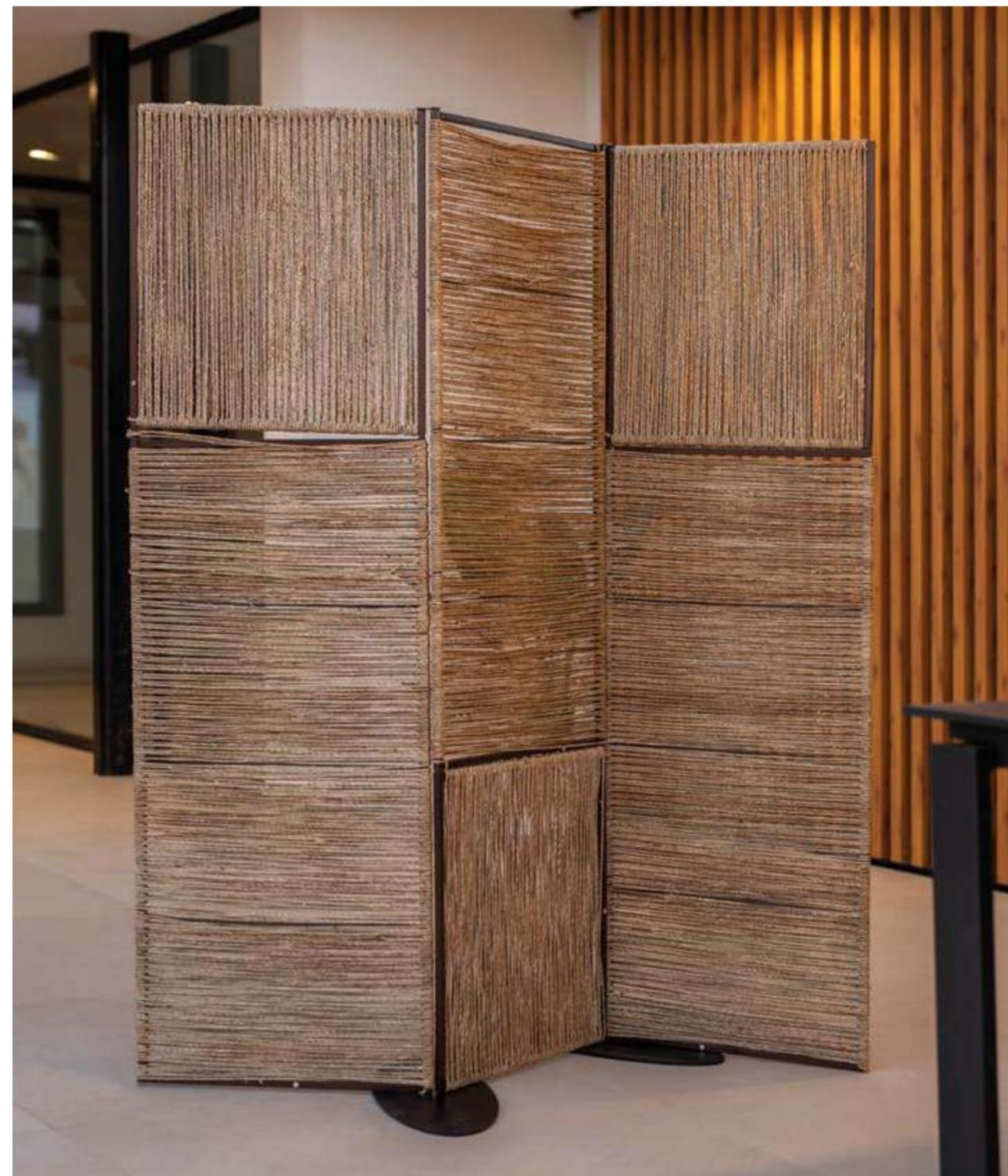

Milos.

Rasa.

Options

Color



+ Info P. 225

Rasa

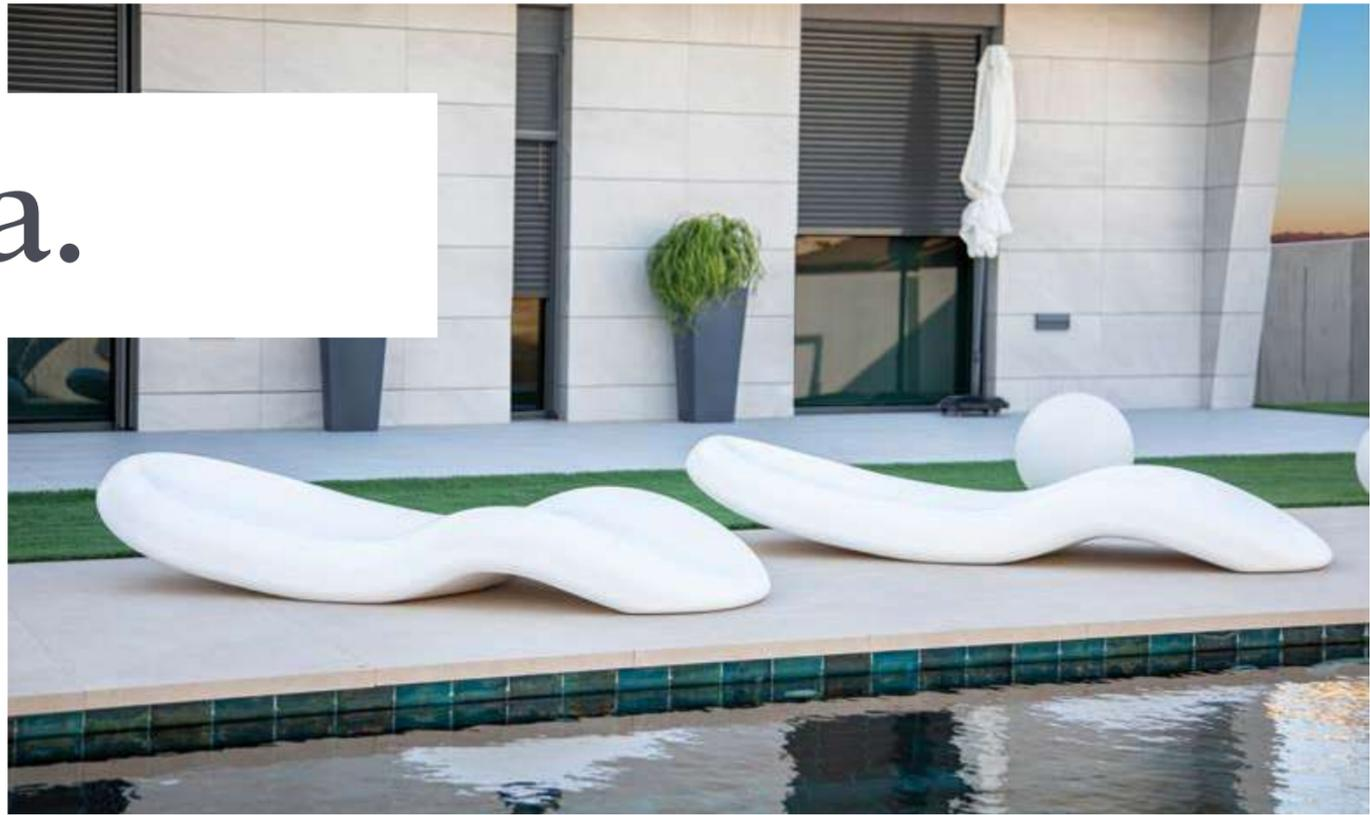

Formentera.

Options

Light | Cable
 Solar + Battery

Color |

Textile accessories

164

65



Formentera



New Island.



Options

- Light |  Cable
 Solar + battery 

Color | ●

+ Info P. 224, 225





Tarida Set.



Options

- Light | Solar & battery  
 Play light&music  

Color |

+ Info P. 224, 226

66



Tarida sit

30



Tarida tab

66



Tarida sit arms

Capri & Mallorca.



Options

- Light | Cable Solar + Battery

Color |

+ Info P. 223, 225



Capri cover included
Itaca weight stability included



Itaca & Mallorca.





Options

Light

- Cable
- Solar + Battery 

Color

-

+ Info P. 227



Sicilia 75

Sicilia 120

Sicilia.

Options

Light |  Cable  Solar + Battery

Color |

+ Info P. 227, 226

Cover included - Shelf not included

	119x59	120x59
		
110		
	Ibiza	Creta

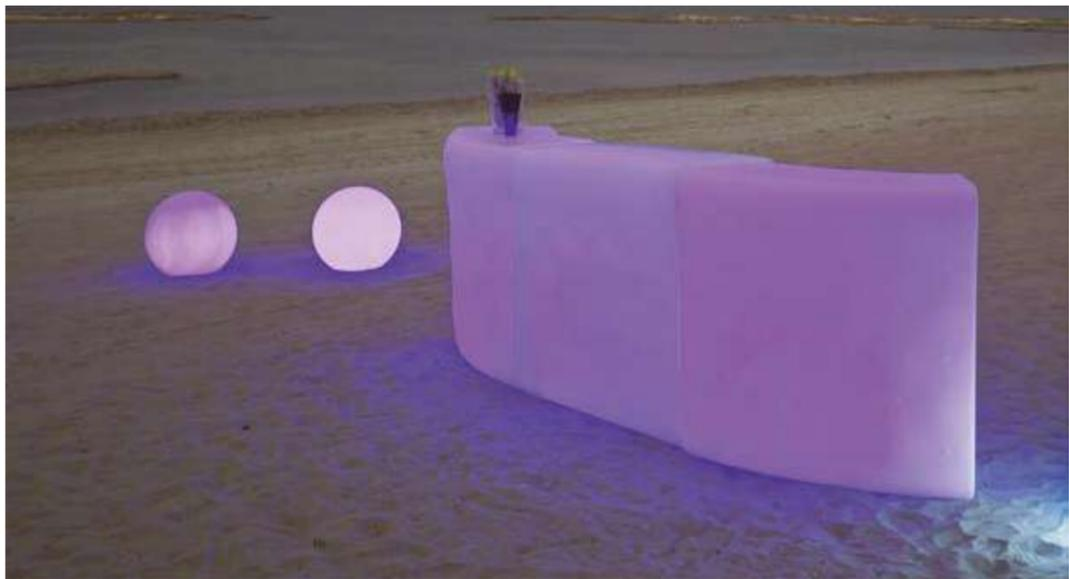

Ibiza & Creta.



Palma
bottle rack

Palma Bottle Rack



Options

- Light
- Solar + Battery

Cooler accessory
available

+ Info P. 227

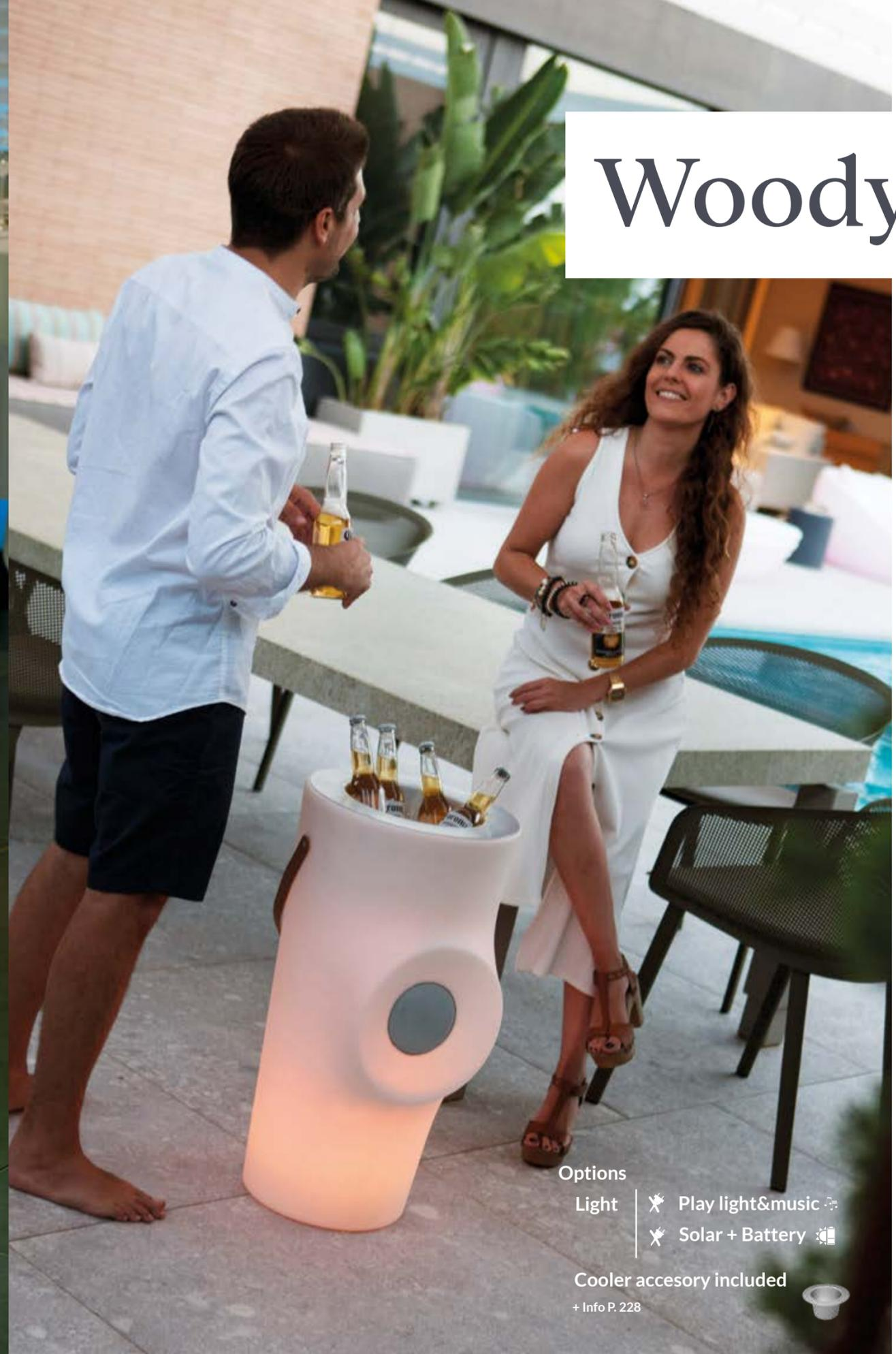

Woody.

Options

- Light
- Play light&music
- Solar + Battery

Cooler accessory included

+ Info P. 228



Woody

Options

Light

- Solar + Battery 
- Battery 

Color

+ Info P. 223, 224



Capri cover included

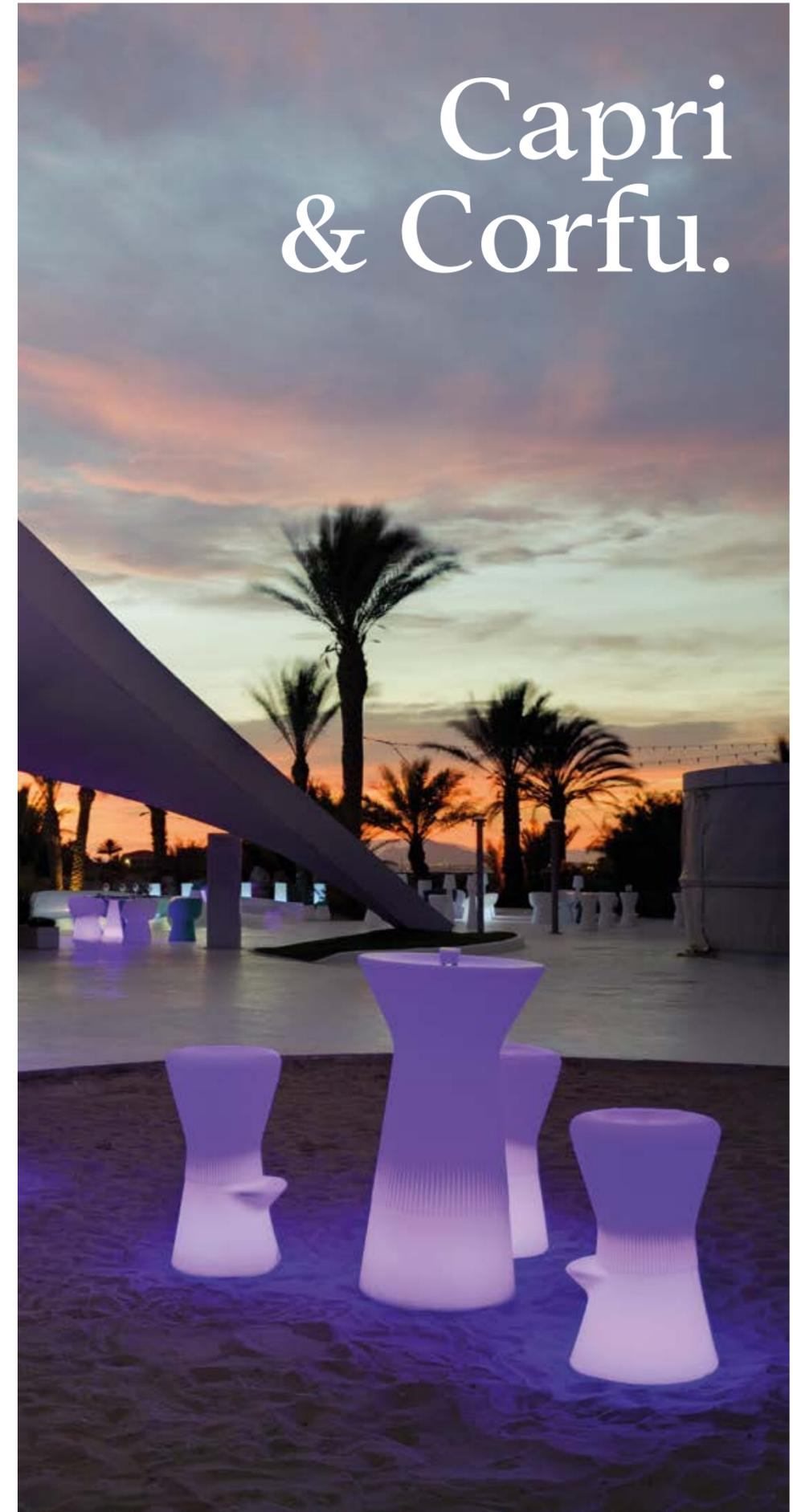

Capri & Corfu.

Pufy & Tafy.



Options

Color |

+ Info P. 225, 226

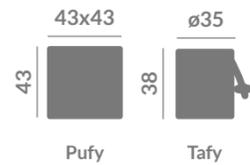

Pufy

Tafy



Capri & Corfu.

Options

Light | Solar + Battery 

Color |

+ Info P. 223, 224

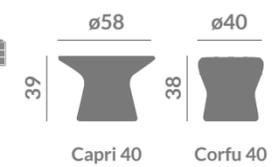

Capri 40

Corfu 40

Capri cover included

Flowerpots.





Olivo.



Options
Color | ● ○ ● ○

+ Info P. 237, 238

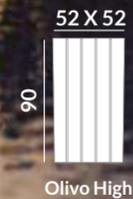

Options

Color | ○ ● ● ● ●

+ Info P. 228, 229



Azalea.



Hortensia.



Options

Color | ○ ● ● ● ● ●

+ Info P. 232, 233



Hortensia 30



Hortensia 40

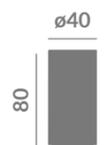

Hortensia 40 high



Hortensia 50



Hortensia 80

Lift Accessory

Available only for Hortensia 30 ● ●



HORTENSIA 40

Options

- Light Cable Solar & battery

- Color

+ Info P. 234, 235

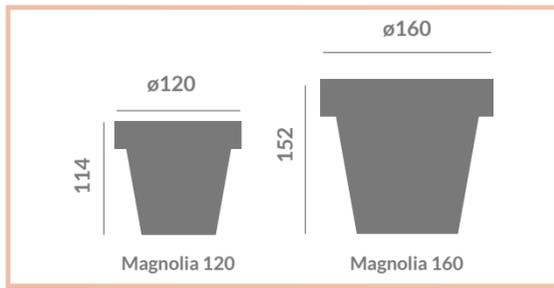
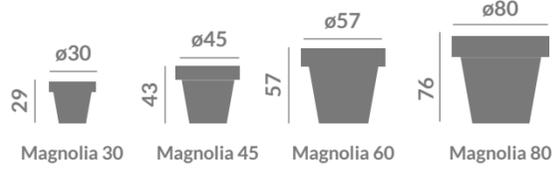

big size XXL



MAGNOLIA 120



MAGNOLIA 45

Magnolia.



MAGNOLIA 30



MAGNOLIA 60



MAGNOLIA 45

Melisa.



MELISA 30



MELISA 50



MELISA 40



Options

- Light | Cable Solar & battery

- Color |
- + Info P. 236

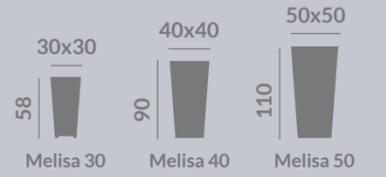

Options

- Light Cable Solar & battery

- Color

+ Info P. 231

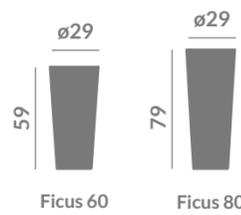

Ficus.



FICUS 60



BAMBU 70



Options

- Light Cable Battery

- Color

- Cooler accessory
- + Info P. 229

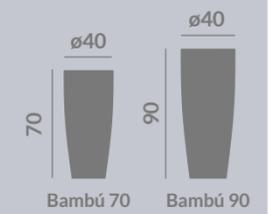

Bambú.





Jara.

Options

Color | ○ ● ● ● ● ●

+ Info P. 233, 234

	100x35	100x40
32		36
	Jara 100x35	Jara 100x40

Junco.

Options

Light | Cable
 Solar & battery

Color | ○ ● ● ● ● ●

+ Info P. 234

	80x32
80	
	Junco 80

Narciso.



NARCISO 60



NARCISO 40



Options

- Light Cable Solar & battery

- Color

+ Info P. 236, 237

35x35



Narciso 35

40x40



Narciso 40

49x49



Narciso 50

59x59



Narciso 60

Options

- Light Cable Solar & battery

+ Info P. 238

ø35



Palma 70

Palma.



Violeta.

Options

Light Cable
 Solar & battery

Color

+ Info P. 238, 239



Violeta 30

Violeta 40

Violeta 55

*new
garden*
be happy

www.newgarden.es

Technical Data.

Technical Data.

1. Materials
2. Polyethylene Textures
3. Colours & Finishes
4. Use according to IP
5. Lighting System
6. Glossary
7. Measurement & References
 - .Lighting
 - . Floor lamps
 - . Decorative
 - . Garlands
 - . Portable Hanging lamps
 - . Table Lamps
 - . Speakers
 - . Functional
 - . Essentials
 - . Furniture
 - . Tables
 - . Seats
 - . Bar
 - . Flowerpots

I. Materials.

	MATERIAL	FIND IT AT:
Plastic	Polyethylene (PE)	It is mainly found in products manufactured by rotational moulding.
	ABS	Enoki, Chiara, Norai, Bitá, Sora
	PVC	Covering of the garlands bulbs, Luceo, Cherry
	Silicone	Rocket 20, Panchito
	Polyamide	Nómada
	PP Difusor	Lola Slim 30, Lola 20, Wally family
	Recycled Plastic	Greta, Gretita, Candy, Edy, Wally
Metal	Painted Iron	Chloe Plant, Lola slim, Amalfi, Niza, Bruna, Siroco, Hortensia Lift
	Aluminium	Cooler
	Steel	Weight Paquita, Pepita & Fity
Organic	Phenolic Compounds	Itaca, Creta accesory
	Bamboo*	Reona, Ilaria, Tarida Arms, Hiama, Okinawa
	Rattan*	Amalfi, Bossa, Calobra, Saona, Santorini
	Jute*	Allegra, Aurora garlands
	Seagrass *	Benirrás, Positano, Sisine, Niza, Milos
	Beechwood *	Chloe, Rocket family
	Esparto *	Alba
Glass	Glass	Chiara, Ilaria, Simona Bulbs
Fabric	Composition: 80% PVC 18% PES 2% PU	Formentera Mattres & Pillow, Tarida Sit
Vegan Leather	Synthetic leather. Polyurethane.*	Kurby, Woody
Ceramic		Bora marble
Methacrylate	PMMA: High resistance to external aggressions Non-porous surface	Creta, Ibiza, Tarida tab, Capri family, Sicilia. Lola 20 Lux

Some products may have a combination of several materials, in which case we will refer to the predominant material of the product.

(*)For the proper maintenance, it is advisable to protect them from rain, direct exposure to the sun and sudden changes in temperatures. Bamboo, rattan beechwood or seaweed are natural materials, reason why changes of colour or cracks can happen. If they are going to be exposed to natural elements, it is recommended to protect them regularly with some oil or varnish appropriate for each specific material, so the protection to rain and UVA rays will be prolonged and the life of the product can be extended. To clean them up, use a cloth or a brush to remove dust and rub gently with a slightly moistened sponge.

2. Polyethylene Textures.

Newgarden's products made of polyethylene have a visually smooth and softly granulated finish that is very pleasant to the touch.



SMOOTH TEXTURE
Polyethylene

The rustic finish can be found in a very specific selection of flowerpots.



RUSTIC TEXTURE
Polyethylene

3. Colours & Finishes.

TRANSLUCENT POLYETHYLENE & ABS



TRANSLUCENT WHITE
Polyethylene



TRANSLUCENT LIME
Polyethylene

OPAQUE polyethylene



OPAQUE WHITE
Polyethylene



OPAQUE BLACK
Polyethylene



OPAQUE BRONZE
Polyethylene



OPAQUE ANTHRACITE
Polyethylene



OPAQUE TERRACOTTA
Polyethylene



OPAQUE TAUPE
Polyethylene

Other materials



OPAQUE GLOSSY WHITE
ABS



OPAQUE GLOSSY BLACK
ABS



OPAQUE WHITE
Metal



OPAQUE MINT
Metal



OPAQUE BRASS
Metal



OPAQUE ROSE GOLD
Metal



OPAQUE SPACE GREY
Metal



OPAQUE ANTHRACITE
Metal



OPAQUE LIME
Metal



OPAQUE WOOD EFFECT
Metal



OPAQUE GREY
ABS



OPAQUE BEIGE
ABS

4. Use according to IP

Here you can find information about the possible uses of Newgarden's products according to their IP (index of protection of the electrical or electronic system against external agents)



Newgarden's products with IP20 can only be used indoors, the electrical system, switches or cables must be protected from direct contact with water. Note that, although the product is made of Polyethylene, which is resistant to the outside, the electrical system is designed for **indoor use only**.



Newgarden's products with IP 43 / 44 can be used outdoors, it is protected against dust and weak and very moderate rain. **If these product also has accessories made of natural fibres, wood or metal parts, it is advisable to protect it from direct contact with water and humidity.** Store in a dry place after use. In the event of rain or very adverse weather conditions, it should be protected from the elements to avoid future problems.



Newgarden's products with IP 54 can be used outdoors, as they are protected against dust and light rain. If these product also has accessories made of natural fibres, wood or metal parts, it is advisable to protect it from direct contact with water and humidity. Store in a dry place after use. In case of rain or very adverse weather conditions it must be protected from the weather to avoid future problems.



Newgarden's products with IP 65 can be used outdoors, they are airtight against dust and rain. **If these product also has accessories made of natural fibres, wood or metal parts, it is advisable to protect it from direct contact with water and humidity.** Store in a dry place after use. In case of rain or very adverse weather conditions it must be protected from the weather to avoid future problems.



Newgarden's products with IP 68 can be used outdoors, they are airtight against dust and rain. **They are also floating (not submersible) so they can be used in the pool.** In case of very adverse weather conditions they must be protected from the elements to avoid future problems.



5. Lighting System

CABLE



CABLE OUTDOOR USE | LIGHT BULB

FEATURES

- White LED light Bulb 6500K(INCLUDED)
- IP65 — Outdoor & indoor use



CABLE OUTDOOR USE | LIGHT TUBE

FEATURES

- White LED light Tube 6500K(INCLUDED)
- IP65 — Outdoor & indoor use



JUTE CABLE OUTDOOR USE | LIGHT TUBE

FEATURES

- White LED light Tube 6500K(INCLUDED)
- IP65 — Outdoor & indoor use



* LED white light Tube 2700K(INCLUDED) Aviable



JUTE CABLE OUTDOOR USE | LIGHT BULB

FEATURES

- LED light bulb range 2700 to 6500K (warm, cold and neutral) (INCLUDED)
- Remote control(INCLUDED)
- Dimmable - Adjustable light intensity and temperature
- IP65 — Outdoor & indoor use



JUTE CABLE OUTDOOR USE | INTEGRATED LIGHT

FEATURES

- Warm LED light 4000K(INTEGRATED)
- Touch control
- Dimmable - Adjustable light intensity
- IP44 — Outdoor & indoor use



BRUNA CABLE OUTDOOR USE | INTEGRATED LIGHT BULB

FEATURES

- Warm LED light 3000K(INTEGRATED)
- IP44 — Outdoor & indoor use



TRANSPARENT CABLE INDOOR USE | LIGHT BULB

FEATURES

- Warm LED light 2700K(INCLUDED)
- Hand switch
- IP20 — Indoor use



Carmen
45

GARLANDS CABLE OUTDOOR USE | LIGHT BULB

FEATURES

- Warm LED light 2700K(INCLUDED)
- Connect multiple garlands
- IP44 — Outdoor & indoor use



Allegra
White



Allegra
Black



Allegra
Pink



Bruna
White



Bruna
Turquoise



Chelsea

GARLANDS CABLE OUTDOOR USE | RGB LIGHT

FEATURES

- RGB LED light bulb 2700K(INTEGRATED)
- Remote control (INCLUDED)
- IP44 — Outdoor & indoor use



Allegra
Black
RGB

GARLAND TRANSPARENT CABLE OUTDOOR USE | INTEGRATED LIGHT

FEATURES

- Warm LED light 2700K(INTEGRATED)
- Connect multiple garlands
- IP44 — Outdoor & indoor use



Luceo
3x2



Stella

GARLAND TRANSPARENT CABLE OUTDOOR USE | INTEGRATED LIGHT

FEATURES

- Warm LED light 2700K(INTEGRATED)
- IP44 — Outdoor & indoor use



Luceo
6x3

GARLANDS JUTE CABLE OUTDOOR USE | LIGHT BULB

FEATURES

- Warm LED light 2700K(INCLUDED)
- Connect multiple garlands
- IP44 — Outdoor & indoor use



Alba



Allegra



Aurora

SOLAR

SOLAR + RECHARGEABLE BATTERY INDOOR & OUTDOOR USE

FEATURES

- Warm LED light 3000K(INTEGRATED)
- Twilight sensor
- IP65 — Outdoor use



Bruna
x1



Bruna
x3



Greta

SOLAR + RECHARGEABLE BATTERY

FEATURES

- Warm LED light Bulb 2700 (INCLUDED)
- Remote control(INCLUDED)
- Dimmable - Adjustable light intensity
- IP54 — Outdoor & indoor use



Chiara



Cherry
Solar



Ilaria



Okinawa



Simona



SOLAR + RECHARGEABLE BATTERY INDOOR & OUTDOOR USE

- RGB LED light Bulb (INCLUDED)
- Integrated LED light range 2700 to 6500K (warm, cold and neutral) (INCLUDED)
- Remote control (INCLUDED)
- Twilight sensor
- Dimmable - Adjustable light intensity
- IP65 — Outdoor & indoor use

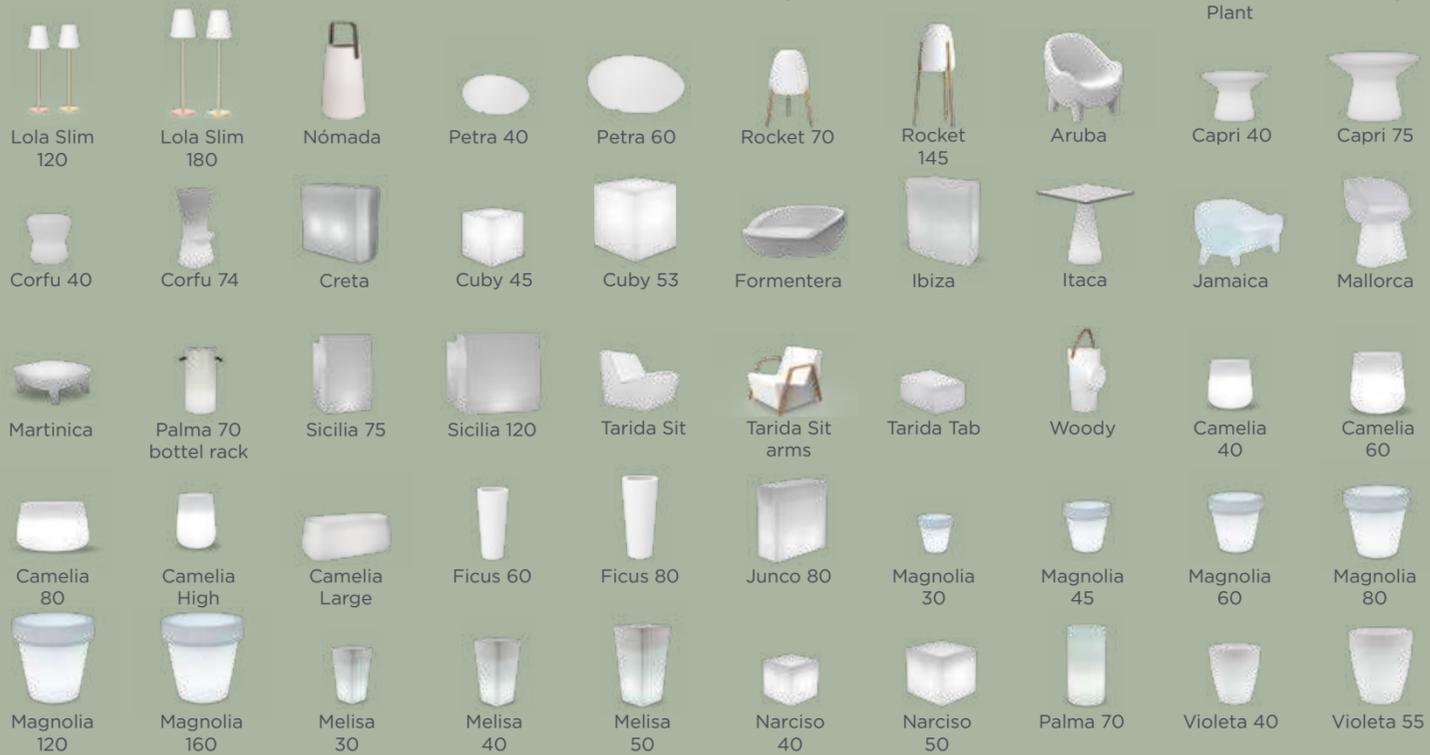

Buly 20 / 30 / 40
Floating, Non sumersible



SOLAR + RECHARGEABLE BATTERY INDOOR & OUTDOOR USE

- Warm LED light Bulb 2700 (INCLUDED)
- Twilight sensor
- IP44 — Outdoor & indoor use



SOLAR HYBRID OUTDOOR USE | INTEGRATED LIGHT

- Solar Charge & power supply
- Warm LED light Bulb 4000K (INTEGRATED)
- Remote control (INCLUDED)
- Twilight sensor
- Motion sensor
- IP65 — Outdoor use



For the hybrid system to work, the lamp requires a minimum of solar energy.



SOLAR OUTDOOR USE | INTEGRATED LIGHT

- Only solar charge
- Warm LED light Bulb 4000K (INTEGRATED)
- Remote control (INCLUDED)
- Twilight sensor
- Motion sensor
- IP65 — Outdoor & indoor use



SOLAR OUTDOOR USE | INTEGRATED LIGHT GRETITA & WALLY

- Solar charge only
- Warm LED light Bulb 3500K (INTEGRATED)
- Twilight sensor
- IP65 — Outdoor & indoor use



SOLAR OUTDOOR USE | INTEGRATED LIGHT WALLY

- FEATURES**
- ☀️ Only solar charge
 - 💡 Warm LED light Bulb 4000K (INTEGRATED)
 - 🌙 Twilight sensor
 - 🚶 Motion sensor
 - IP65** Outdoor & indoor use



SOLAR OUTDOOR USE | INTEGRATED LIGHT HIAMA

- FEATURES**
- ☀️ Only solar charge
 - 🔥 Flame LED effect Bulb 1700K (INTEGRATED)
 - 🌙 Twilight sensor
 - IP65** Outdoor & indoor use



SOLAR AUTOMATIC OUTDOOR USE | INTEGRATED LIGHT

- FEATURES**
- ☀️ Solar charge only
 - 💡 White LED light Bulb 6500K (INTEGRATED)
 - 🌙 Twilight sensor
 - 🌊 Floating, Non submersible
 - IP68** Outdoor & indoor use

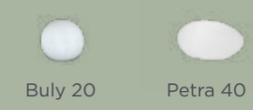

RECHARGEABLE BATTERY

RECHARGEABLE BATTERY INDOOR & OUTDOOR USE | PANCHITO & ROCKET

- FEATURES**
- 💡 Warm LED light Bulb 2700K (INCLUDED)
 - 👉 Tapping control
 - 📊 Dimmable - Adjustable light intensity
 - IP43** Outdoor & indoor use



RECHARGEABLE BATTERY INDOOR & OUTDOOR USE | CHERRY BULB

- FEATURES**
- 💡 Warm LED light Bulb 2700K (INCLUDED)
 - 📶 Remote control(INCLUDED)
 - 📊 Dimmable - Adjustable light intensity
 - IP54** Outdoor & indoor use



RECHARGEABLE BATTERY INDOOR & OUTDOOR USE | LIGHT BULB

- FEATURES**
- 💡 Integrated LED light range 2700 to 6500K (warm, cold and neutral) (INCLUDED)
 - 📶 Remote control(INCLUDED)
 - 📊 Dimmable - Adjustable light intensity and temperature
 - IP65** Outdoor & indoor use

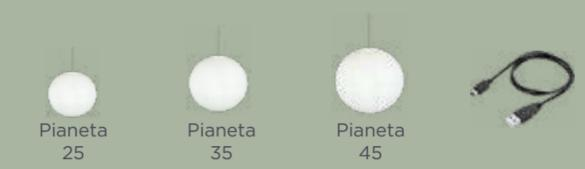

RECHARGEABLE BATTERY INDOOR & OUTDOOR USE |

- FEATURES**
- 💡 Warm LED light bulb 2700K/3000K (INCLUDED)
 - 👉 Touch control
 - 📊 Dimmable - Adjustable light intensity
 - IP44** Outdoor & indoor use



RECHARGEABLE BATTERY INDOOR & OUTDOOR USE | RGB LIGHT TUBE

- FEATURES**
- RGB LED light Tube (INCLUDED)
 - Remote control(INCLUDED)
 - Dimmable - Adjustable light intensity and temperature
 - IP54** — Outdoor & indoor use



RECHARGEABLE BATTERY INDOOR & OUTDOOR USE | CANDY

- FEATURES**
- Flame LED effect Bulb (INTEGRATED)
 - Integrated warm LED light Bulb (INTEGRATED)
 - Remote control (INCLUDED)
 - Dimmable - Adjustable light intensity
 - IP54** — Outdoor & indoor use



RECHARGEABLE BATTERY INDOOR & OUTDOOR USE | LIGHT BULB

- FEATURES**
- RGB LED light Bulb (INCLUDED)
 - Integrated LED white light Bulb (INCLUDED)
 - Remote control (INCLUDED)
 - Dimmable - Adjustable light intensity
 - IP65** — Outdoor & indoor use



RECHARGEABLE BATTERY INDOOR & OUTDOOR USE | LOLA 20 BATTERY

- FEATURES**
- RGB LED light Bulb (INTEGRATED)
 - White LED light Bulb (INTEGRATED)
 - Touch control
 - IP43** — Outdoor & indoor use



RECHARGEABLE BATTERY INDOOR & OUTDOOR USE | EDY

- FEATURES**
- Warm LED light Bulb 2700K (INCLUDED)
 - Remote control(INCLUDED)
 - Dimmable - Adjustable light intensity
 - IP54** — Outdoor & indoor use



REPLACEABLE BATTERIES INDOOR USE | LOLA 20 AAA

- FEATURES**
- RGB LED light Bulb (INTEGRATED)
 - Smooth mode only - automatic change of colours
 - Indoor use
 - IP20** —



WALL OUTDOOR USE | BULB LIGHT NOT INCLUDED

- FEATURES**
- Installation required
 - E27 light bulb base
 - IP44** — Outdoor use & indoor use



WALL

PLAY: LIGHT & MUSIC



PLAY: LIGHT & MUSIC RECHARGEABLE BATTERY

INDOOR & OUTDOOR USE | INTEGRATED LIGHT & SPEAKERS

FEATURES

- Integrated Speakers
- Bluetooth connection
- RGB LED light Bulb (INCLUDED)
- Integrated White LED bulb
- Remote control (INCLUDED)
- Dimmable - Adjustable light intensity
- IP43** — Outdoor & indoor use



Cuby 45



Kurby



Nómada



Tarida tab



Woody

HANG



HANG OUTDOOR USE | BULB LIGHT NOT INCLUDED

FEATURES

- Installation required
- E27 bulb cap
- IP44** — Outdoor use & indoor use



Cloudy



Petra 40 hang



Petra 60 hang



HANG OUTDOOR USE | BULB LIGHT INCLUDED

FEATURES

- Installation required
- Integrated LED light range 2700 to 6500K (warm, cold and neutral) (INCLUDED)
- Remote control (INCLUDED)
- Dimmable - Adjustable light intensity and temperature
- IP44** — Outdoor use & indoor use



Pianeta 25



Pianeta 35



Pianeta 45

6. Glossary.



COLD LIGHT
LUZ FRÍA



RGB LIGHT
LUZ RGB



WARM LIGHT
LUZ CÁLIDA



WARM PORTABLE RECHARGEABLE LIGHT BULB
BOMBILLA RECARGABLE PORTÁTIL LUZ CÁLIDA

LED TUBE
TUBO LED

LED TUBE
TUBO LED



FLAME EFFECT LED LIGHT
LUZ LED EFECTO LLAMA



REMOTE CONTROL
MANDO A DISTANCIA



DIMMER
DIMABLE



TWILIGHT SENSOR
SENSOR CREPUSCULAR



MOTION SENSOR
SENSOR DE MOVIMIENTO



ELECTRIC CHARGE (DRIVER NOT INCLUDED)
CARGA ELÉCTRICA (DRIVER DE CARGA NO INCLUIDO)



HANGING
COLGANTE



INTEGRATED SPEAKER
ALTAVOZ INTEGRADO



FLOATING (NON SUBMERSIBLE)
FLOTANTE (NO SUMERGIBLE)



TOUCH CONTROL
CONTROL TÁCTIL



MADE OF RECYCLED MATERIALS
FABRICADO CON MATERIALES RECICLADOS



ARTIFICIAL PLANTS INCLUDED
PLANTAS ARTIFICIALES INCLUIDAS



PLANTATION VOLUME
VOLUMEN DE PLANTACIÓN

This technical catalogue is subject to periodic updates, the measurements or finishes may vary in future revisions.

7. Measurement & References.



FLOOR LAMPS _____ P 198
DECORATIVE _____ P 203

GARLANDS _____ P 205
PORTABLE HANG _____ P 207

TABLE LAMPS _____ P 211
SPEAKERS _____ P 214

FUNCTIONAL _____ P 214
ESSENTIAL _____ P 220

FLOOR LAMPS

AMALFI | NATURE COLLECTION

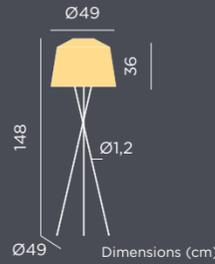

OPTIONS

- Rechargeable Battery | Indoor & outdoor use | ○ Black colour
- + Cherry bulb included

Packaging: 57 x 64 x 51,5 cm | Gross Weight (Packaged Weight): 8,36kg

Im REFERENCES
900 LUMAMA145BXWLNW

CARMEN 110



OPTIONS

- Rechargeable Battery | Indoor & outdoor use
- Cable | Indoor & outdoor use

Packaging: 31,5 x 31,5 x 112,5 cm | Gross Weight (Packaged Weight): 4,5kg | Floor anchorage included.

Im REFERENCES
360 LUMCRI110WLNW
1.600 LUMCRI110OFNW

CARMEN 165



OPTIONS

- Rechargeable Battery | Indoor & outdoor use
- Cable | Indoor & outdoor use

Packaging: 46,4 x 46,4 x 165,5 cm | Gross Weight (Packaged Weight): 9,5kg | Floor anchorage included.

Im REFERENCES
415 LUMCRI165WLNW
2.000 LUMCRI165OFNW

CHLOE 140

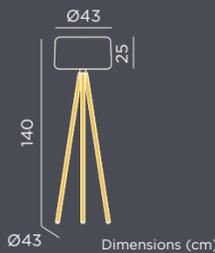

OPTIONS

- Solar & Rechargeable Battery | Indoor & outdoor use
- Cable Jute | IN&OUT Indoor & Outdoor use

Packaging: 31,6 x 46 x 123 cm | Gross Weight (Packaged Weight): 5,2 kg

Im REFERENCES
600 LUMCHL140SSNW
860 LUMCHL140INOUTNW

CHLOE PLANT

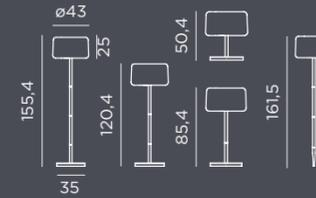

OPTIONS

- Solar & Rechargeable Battery | Indoor & outdoor use
- Wood colour

Packaging: 45,5 x 45,5 x 45,5 cm | Gross Weight (Packaged Weight): 13,5kg

Im REFERENCES

600 LUMCHLPLTSSNW

FITY 100

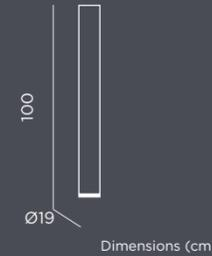

OPTIONS

- Rechargeable Battery | Indoor & outdoor use
- Cable Jute | Indoor & outdoor use
- Cable Jute | Indoor & outdoor use

Packaging: 19,5 x 19,5 x 105 cm | Gross Weight (Packaged Weight): 4,7kg | Weight stability included.

Im REFERENCES

360 LUMFT100TWLNW
1.400 LUMFT100OFNW
1.400 LUMFT100OCNW

FITY 160

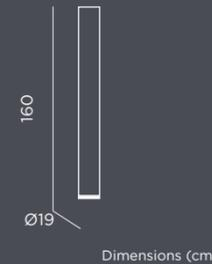

OPTIONS

- Rechargeable Battery | Indoor & outdoor use
- Cable Jute | Indoor & outdoor use
- Cable Jute | Indoor & outdoor use

Packaging: 19,5 x 19,5 x 165 cm | Gross Weight (Packaged Weight): 6,2kg | Weight stability included.

Im REFERENCES

415 LUMFT160TWLNW
2.000 LUMFT160OFNW
2.000 LUMFT160OCNW

FREDO 140

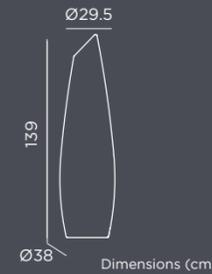

OPTIONS

- Rechargeable Battery | Indoor & outdoor use
- Cable | Indoor & outdoor use

Packaging: 39 x 39 x 140 cm | Gross Weight (Packaged Weight): 6kg | Floor anchorage included.

Im REFERENCES

360 LUMFD140TWLNW
1.800 LUMFD140OFNW

FREDO 170

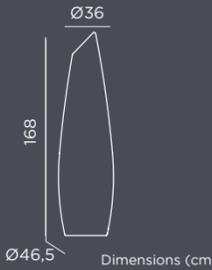

OPTIONS

- Rechargeable Battery | Indoor & outdoor use
- Cable | Indoor & outdoor use

Packaging: 48 x 48 x 170 cm | Gross Weight (Packaged Weight): 8,5kg | Floor anchorage included.

Im REFERENCES

415 LUMFD170WLNW
2.000 LUMFD170OFNW

GLOSSARY This technical catalogue is subject to periodic updates, the measurements or finishes may vary in future revisions.

☀ White light (included) ☀ Warm light (included) 🌈 RGB light (included) 🔋 Warm light portable rechargeable battery (included) 📶 Led tube lighting (included) 🔥 Led light flame effect 🌙 Twilight sensor 📶 Motion sensor 🔌 Electric charge (driver not included) 📶 Remote control (included) 📶 Dimmable 📶 Hanging product 📶 Floating, not submersible 📶 Integrated speakers 📶 Touch control 📶 Volumen of the plantation area IP Indicates the level of protection of the electrical or electronic equipment against the entry of external agents: dust or water ♻ Made of recyclable materials 🌿 Artificial plants included

GLOSSARY This technical catalogue is subject to periodic updates, the measurements or finishes may vary in future revisions.

☀ White light (included) ☀ Warm light (included) 🌈 RGB light (included) 🔋 Warm light portable rechargeable battery (included) 📶 Led tube lighting (included) 🔥 Led light flame effect 🌙 Twilight sensor 📶 Motion sensor 🔌 Electric charge (driver not included) 📶 Remote control (included) 📶 Dimmable 📶 Hanging product 📶 Floating, not submersible 📶 Integrated speakers 📶 Touch control 📶 Volumen of the plantation area IP Indicates the level of protection of the electrical or electronic equipment against the entry of external agents: dust or water ♻ Made of recyclable materials 🌿 Artificial plants included

GRACE 140

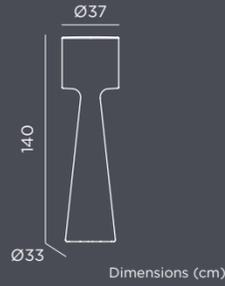

OPTIONS

	Rechargeable Battery Indoor & outdoor use			390	LUMGC140WLNW
	Cable Indoor & outdoor use			1.800	LUMGC140OFNW

Packaging: 38 x 38 x 140 cm | Gross Weight (Packaged Weight): 6,5kg | Floor anchorage included.

Im REFERENCES

GRACE 170

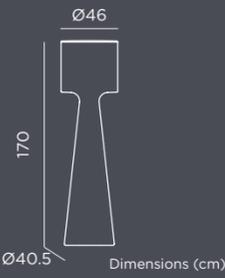

OPTIONS

	Rechargeable Battery Indoor & outdoor use			415	LUMGC170WLNW
	Cable Indoor & outdoor use			2.000	LUMGC170OFNW

Packaging: 46 x 46 x 170 cm | Gross Weight (Packaged Weight): 8,5kg | Floor anchorage included.

Im REFERENCES

KONIKA 170

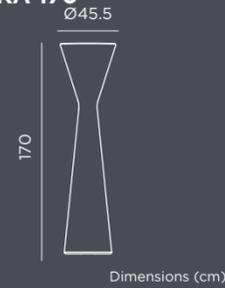

OPTIONS

	Rechargeable Battery Indoor & outdoor use			415	LUMKNI170WLNW
	Cable Indoor & outdoor use			2.000	LUMKNI170OFNW

Packaging: 45,8 x 45,8 x 171 cm | Gross Weight (Packaged Weight): 7,5kg | Floor anchorage included.

Im REFERENCES

LOLA 110

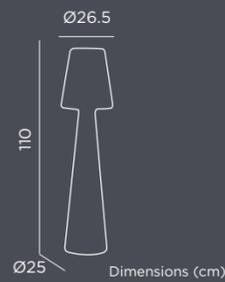

OPTIONS

	Rechargeable Battery Indoor & outdoor use			360	LUMLL110WLNW
	Cable Indoor & outdoor use			1.600	LUMLL110OFNW

Packaging: 26,5 x 26,5 x 111,5 cm | Gross Weight (Packaged Weight): 3,5kg | Floor anchorage included.

Im REFERENCES

LOLA 165

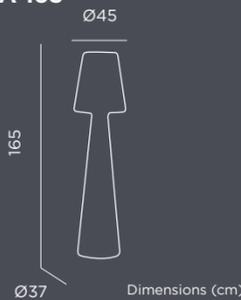

OPTIONS

	Rechargeable Battery Indoor & outdoor use			415	LUMLL165WLNW
	Cable Indoor & outdoor use			2.000	LUMLL165OFNW

Packaging: 45,5 x 45,5 x 166 cm | Gross Weight (Packaged Weight): 10,25kg | Floor anchorage included.

Im REFERENCES

LOLA 200

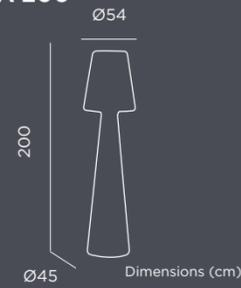

OPTIONS

	Cable Indoor & outdoor use			2.200	LUMLL200OFNW
--	------------------------------	--	--	-------	--------------

Packaging: 55,5 x 55,5 x 200,5 cm | Gross Weight (Packaged Weight): 12,5kg | Floor anchorage included.

Im REFERENCES

LOLA SLIM 120

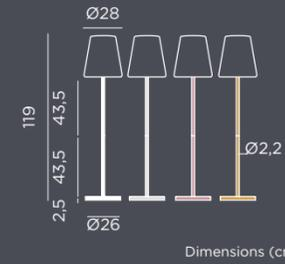

OPTIONS

	Solar & Rechargeable Battery Indoor & outdoor use				600	LUMLLS120RGSSNW
	Solar & Rechargeable Battery Indoor & outdoor use				600	LUMLLS120BRSSNW
	Solar & Rechargeable Battery Indoor & outdoor use				600	LUMLLS120GESSNW
	Solar & Rechargeable Battery Indoor & outdoor use				600	LUMLLS120ANSSNW

Packaging: 39 x 39 x 39,5 cm | Gross Weight (Packaged Weight): 7kg | Weight stability included.

Im REFERENCES

LOLA SLIM 180

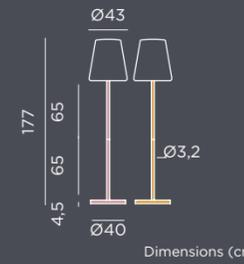

OPTIONS

	Solar & Rechargeable Battery Indoor & outdoor use				800	LUMLLS180RGSSNW
	Cable Jute IN&OUT Indoor & outdoor use				860	LUMLLS180RGINOUTNW
	Solar & Rechargeable Battery Indoor & outdoor use				800	LUMLLS180BRSSNW
	Cable Jute IN&OUT Indoor & outdoor use				860	LUMLLS180BRINOUTNW

Packaging: 47 x 54 x 57,5 cm | Gross Weight (Packaged Weight): 19,65kg | Weight stability included.

Im REFERENCES

NIZA 165 | NATURE COLLECTION

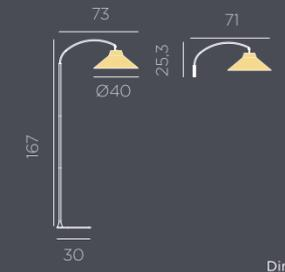

OPTIONS

	Rechargeable Battery Indoor & outdoor use				900	LUMNIZ165NXWLNW
--	---	--	--	--	-----	-----------------

+ Cherry bulb included

Packaging: 46,5 x 41 x 26,5 cm | Gross Weight (Packaged Weight): 6,4kg.

Im REFERENCES

NIZA 230 | NATURE COLLECTION

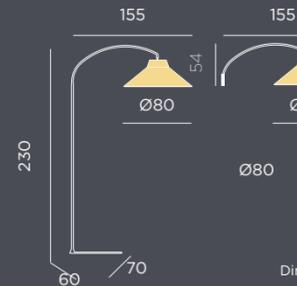

OPTIONS

	Rechargeable Battery Indoor & outdoor use				900	LUMNIZ230BXWLNW
--	---	--	--	--	-----	-----------------

+ Cherry bulb included

Packaging: 82,5 x 92,5 x 46,5 cm | Gross Weight (Packaged Weight): 24,3kg.

Im REFERENCES

GLOSSARY This technical catalogue is subject to periodic updates, the measurements or finishes may vary in future revisions.

White light (included) Warm light (included) RGB light (included) Warm light portable rechargeable battery (included) Led tube lighting (included) Led light flame effect Twilight sensor Motion sensor Electric charge (driver not included) Remote control (included) Dimmable Hanging product Floating, not submersible Integrated speakers Touch control Volumen of the plantation area **IP** Indicates the level of protection of the electrical or electronic equipment against the entry of external agents: dust or water Made of recyclable materials Artificial plants included

GLOSSARY This technical catalogue is subject to periodic updates, the measurements or finishes may vary in future revisions.

White light (included) Warm light (included) RGB light (included) Warm light portable rechargeable battery (included) Led tube lighting (included) Led light flame effect Twilight sensor Motion sensor Electric charge (driver not included) Remote control (included) Dimmable Hanging product Floating, not submersible Integrated speakers Touch control Volumen of the plantation area **IP** Indicates the level of protection of the electrical or electronic equipment against the entry of external agents: dust or water Made of recyclable materials Artificial plants included

OKINAWA | NATURE COLLECTION

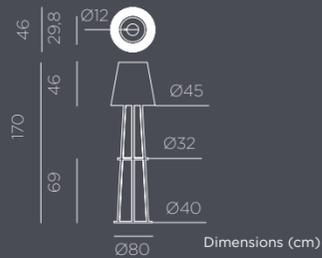

OPTIONS

- Solar & Rechargeable Battery | Indoor & outdoor use | wood 900 LUMOKI170XXSWNW
 - Cherry bulb included
- Packaging: 49 x 49 x 49 cm | Gross Weight (Packaged Weight): 8,7kg

Im REFERENCES

PANCHO 140



OPTIONS

- Rechargeable Battery | Indoor & outdoor use 390 LUMPCI140TWNW
 - Cable | Indoor & outdoor use 1.800 LUMPCI140OFNW
 - Cable | Indoor & outdoor use | Lime colour 1.800 LUMPV140OFNW
- Packaging: 44 x 51 x 140 cm | Gross Weight (Packaged Weight): 7kg | Floor anchorage included.

Im REFERENCES

ROCKET 70

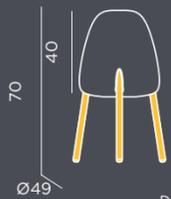

OPTIONS

- Solar & Rechargeable Battery | Indoor & outdoor use 600 LUMRCK70SSNW
 - Cable Jute | IN&OUT Indoor & outdoor use 860 LUMRCK070INOUTNW
- Packaging: 37,5 x 37,5 x 43 cm | Gross Weight (Packaged Weight): 3kg

Im REFERENCES

ROCKET 145

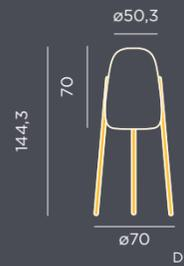

OPTIONS

- Solar & Rechargeable Battery | Indoor & outdoor use 600 LUMRCK145SSNW
 - Cable Jute | IN&OUT Indoor & outdoor use 860 LUMRCK145INOUTNW
- Packaging: 51 x 50,5x 120,5 cm | Gross Weight (Packaged Weight): 8kg

Im REFERENCES

SANTORINI | NATURE COLLECTION

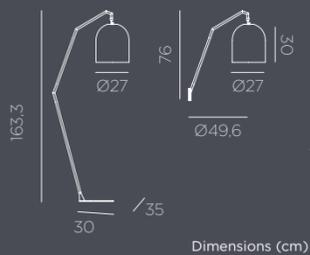

OPTIONS

- Rechargeable Battery | Indoor & outdoor use | White colour 900 LUMSTN165BXWLNW
 - Cherry bulb included
- Packaging: 33,5 x 42,5 x 36 cm | Gross Weight (Packaged Weight): 6,7kg

Im REFERENCES

GLOSSARY This technical catalogue is subject to periodic updates, the measurements or finishes may vary in future revisions.

White light (included) Warm light (included) RGB light (included) Warm light portable rechargeable battery (included) Led tube lighting (included) Led light flame effect Twilight sensor Motion sensor Electric charge (driver not included) Remote control (included) Dimmable Hanging product Floating, not submersible Integrated speakers Touch control Volumen of the plantation area IP Indicates the level of protection of the electrical or electronic equipment against the entry of external agents: dust or water Made of recyclable materials Artificial plants included

DECORATIVE

BALANS

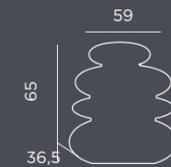

Dimensions (cm)

OPTIONS

- Rechargeable Battery | Indoor & outdoor use 335 LUMBS070TWNW
 - Cable | Indoor & outdoor use 900 LUMBS070OFNW
- Packaging: 60 x 38 x 66,5 cm | Gross Weight (Packaged Weight): 4,5kg

Im REFERENCES

BRUNA 165

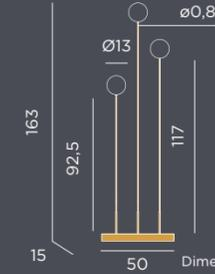

Dimensions (cm)

OPTIONS

- Cable | Indoor & outdoor use | Brass colour 115 LUMBRU165BROCNW
- Packaging: 36 x 56,5 x 168 cm | Gross Weight (Packaged Weight): 4,35kg.

Im REFERENCES

CANDELA



Dimensions (cm)

OPTIONS

- Rechargeable Battery | Indoor & outdoor use 100 LUMCN030WLNW
- Packaging: 20,5 x 20,5 x 29,5 cm | Gross Weight (Packaged Weight): 1,5kg | Vegan leather handle

Im REFERENCES

GOA 40



Dimensions (cm)

OPTIONS

- Rechargeable Battery | Indoor & outdoor use 315 LUMGA040WLNW
 - Cable | Indoor & outdoor use 600 LUMGA040OFNW
- Packaging: 29,5 x 25,7 x 41,6 cm | Gross Weight (Packaged Weight): 1,5kg.

Im REFERENCES

GOA 70



Dimensions (cm)

OPTIONS

- Rechargeable Battery | Indoor & outdoor use 335 LUMGA070WLNW
 - Cable | Indoor & outdoor use 600 LUMGA070OFNW
- Packaging: 51 x 44 x 71 cm | Gross Weight (Packaged Weight): 5,7kg.

Im REFERENCES

GLOSSARY This technical catalogue is subject to periodic updates, the measurements or finishes may vary in future revisions.

White light (included) Warm light (included) RGB light (included) Warm light portable rechargeable battery (included) Led tube lighting (included) Led light flame effect Twilight sensor Motion sensor Electric charge (driver not included) Remote control (included) Dimmable Hanging product Floating, not submersible Integrated speakers Touch control Volumen of the plantation area IP Indicates the level of protection of the electrical or electronic equipment against the entry of external agents: dust or water Made of recyclable materials Artificial plants included

KAKTUS 100

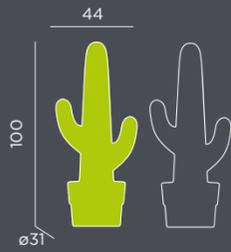

Dimensions (cm)

OPTIONS

- Rechargeable Battery | Indoor & outdoor use 360 LUMKLI00TWNW
- Cable | Indoor & outdoor use 1.400 LUMK1000FNW
- Cable | Indoor & outdoor use | Lime colour 1.400 LUMKLI000FNW

Packaging: 34,2 x 34,2 x 101 cm | Gross Weight (Packaged Weight): 3,7kg | Floor anchorage included.

KURBY 38



Dimensions (cm)

OPTIONS

- Solar & Rechargeable Battery | Indoor & outdoor use 45 LUMKR038SSNW

Packaging: 28 x 28 x 39 cm | Gross Weight (Packaged Weight): 1,8kg | Vegan leather handle

NÓMADA 30



Dimensions (cm)

OPTIONS

- Solar & Rechargeable Battery | Indoor & outdoor use 45 LUMNM032SSNW

Packaging: 20 x 20 x 31 cm | Gross Weight (Packaged Weight): 1,3kg | Metal handle

SAONA 70 | NATURE COLLECTION

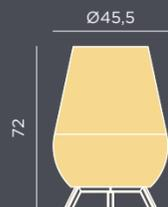

Dimensions (cm)

OPTIONS

- Rechargeable Battery | Indoor & outdoor use* 900 LUMSAO070XXWLNW
- Cable Jute | IN&OUT Indoor & outdoor use 290 LUMSAO070XXIONW

+ *Cherry bulb included

Packaging: 50,4 x 50,4 x 74 cm | Gross Weight (Packaged Weight): 3,5 kg / Cable Jute Gross Weight (Packaged Weight): 4 kg

SIROCO 30

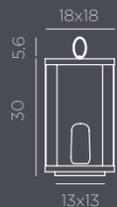

Dimensions (cm)

OPTIONS

- Rechargeable Battery | Indoor & outdoor use | Black colour 200 LUMSRC030BXWLNW

+ Candy lamp included

Packaging: 31,3 x 19 x 19 cm | Gross Weight (Packaged Weight): 1,9kg

SIROCO 50

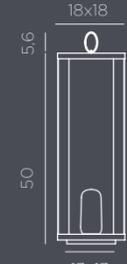

Dimensions (cm)

OPTIONS

- Rechargeable Battery | Indoor & outdoor use 200 LUMSRC050BXWLNW

+ Candy lamp included

Packaging: 51,3 x 19 x 19 cm | Gross Weight (Packaged Weight): 2,5kg

SISINE 70 | NATURE COLLECTION

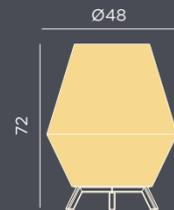

Dimensions (cm)

OPTIONS

- Rechargeable Battery | Indoor & outdoor use* 900 LUMSIS070XXWLNW
- Cable Jute | IN&OUT Indoor & outdoor use 460 LUMSIS070XXIONW

+ *Cherry bulb included

Packaging: 50,4 x 50,4 x 74 cm | Gross Weight (Packaged Weight): 3 kg / Cable Jute Gross Weight (Packaged Weight): 4 kg

GARLANDS

ALBA | NATURE COLLECTION

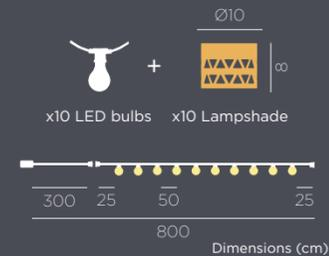

Dimensions (cm)

OPTIONS

- Solar + Rechargeable Battery | Indoor & outdoor use | Jute cable 35° LUMALB800XXSLNW
- Cable | Indoor & outdoor use | Jute cable 35° LUMALB800XXOCNW

Packaging: 30,5 x 21,5 x 19,5cm | Gross Weight (Cable Packaged Weight): 0,8kg | Gross Weight (Solar Packaged Weight): 1,1kg(*) Lumens per bulb

ALLEGRA

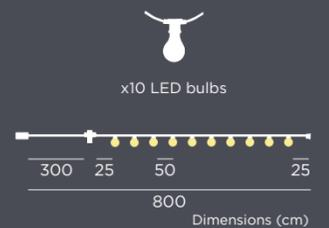

Dimensions (cm)

OPTIONS

- Solar + Rechargeable Battery | Indoor & outdoor use | Jute cable 35° LUMGASXXSLNW
- Solar + Rechargeable Battery | Indoor & outdoor use | White cable 35° LUMGASBXSLNW
- Solar + Rechargeable Battery | Indoor & outdoor use | Black cable 35° LUMGASNXSLNW
- Cable | Indoor & outdoor use | Jute cable 35° LUMGASXXOCNW
- Cable | Indoor & outdoor use | White cable 35° LUMGALLOCBXNW
- Cable | Indoor & outdoor use | Pink cable 35° LUMGALLOCRNW
- Cable | Indoor & outdoor use | Black cable 35° LUMGALLOCNW
- Cable | Indoor & outdoor use | Black cable 20° LUMGALLRGBNW

Packaging Solar + Rechargeable Batt: 21 x 35 x 15 cm | Gross Weight (Packaged Weight): 1,15kg / Packaging Cable: 21 x 35 x 12 cm | Gross Weight (Packaged Weight): 0,8 kg (*) Lumens per bulb

AURORA | NATURE COLLECTION

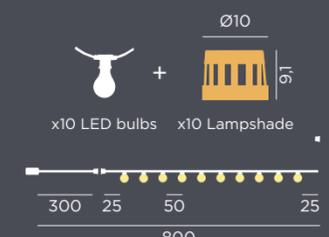

Dimensions (cm)

OPTIONS

- Solar + Rechargeable Battery | Indoor & outdoor use | Jute cable 35° LUMAUR800XXSLNW
- Cable | Indoor & outdoor use | Jute cable 35° LUMAUR800XXOCNW

Packaging Solar + Rechargeable Batt: 28,5 x 15 x 15 cm, Gross Weight (Packaged Weight): 1,5 kg | Packaging Cable: 28,5 x 15 x 13 cm, Gross Weight (Packaged Weight): 0,9 kg (1,2 kg Jute Cable) | Packaging Cable RGB: 28,5 x 15 x 12 cm, Gross Weight (Packaged Weight): 0,9 kg (*) Lumens per bulb

GLOSSARY This technical catalogue is subject to periodic updates, the measurements or finishes may vary in future revisions.

White light (included) Warm light (included) RGB light (included) Warm light portable rechargeable battery (included) Led tube lighting (included) Led light flame effect Twilight sensor Motion sensor Electric charge (driver not included) Remote control (included) Dimmable Hanging product Floating, not submersible Integrated speakers Touch control Volumen of the plantation area IP Indicates the level of protection of the electrical or electronic equipment against the entry of external agents: dust or water Made of recyclable materials Artificial plants included

GLOSSARY This technical catalogue is subject to periodic updates, the measurements or finishes may vary in future revisions.

White light (included) Warm light (included) RGB light (included) Warm light portable rechargeable battery (included) Led tube lighting (included) Led light flame effect Twilight sensor Motion sensor Electric charge (driver not included) Remote control (included) Dimmable Hanging product Floating, not submersible Integrated speakers Touch control Volumen of the plantation area IP Indicates the level of protection of the electrical or electronic equipment against the entry of external agents: dust or water Made of recyclable materials Artificial plants included

BRUNA

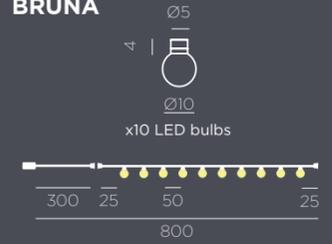

OPTIONS

- Solar + Rechargeable Battery | Indoor & outdoor use | White rope 50°
- Cable | Indoor & outdoor use | White rope 50°
- Cable | Indoor & outdoor use | Turquoise rope 50°

Packaging Solar + Rechargeable Batt: 13 x 28,5 x 15 cm, Gross Weight (Packaged Weight): 2,9 kg Packaging Cable: 13 x 28,5 x 15 cm | Gross Weight (Packaged Weight): 2,75kg (*)Lumens per bulb

Dimensions (cm)

Im REFERENCES

- 50° LUMGBR100BXS LNW
- 50° LUMGBR100BROC NW
- 50° LUMGBR100QXOC NW

CHELSEA

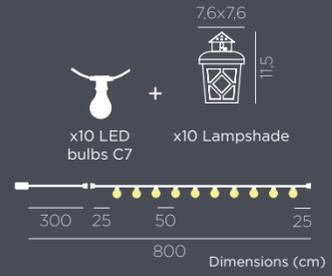

OPTIONS

- Cable | Indoor & outdoor use | Transparent rope 35°

Packaging: 13 x 28,5 x 15 cm | Gross Weight (Packaged Weight): 1,4 kg (*)Lumens per bulb

Dimensions (cm)

Im REFERENCES

- 35° LUMCHE800BXOC NW

LUCEO 3X2

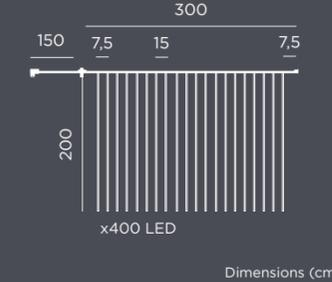

OPTIONS

- Cable | Indoor & outdoor use | Transparent rope NA

Packaging Cable: 18 x 18 x 10 cm | Gross Weight (Packaged Weight): 0,6Kg Link up to two garlands

Dimensions (cm)

Im REFERENCES

- NA LUMLUC320XXOC NW

LUCEO 6X3

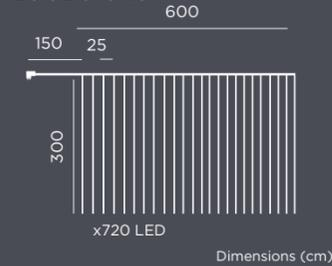

OPTIONS

- Cable | Indoor & outdoor use | Transparent rope NA

Packaging Cable: 18 x 18 x 18 cm | Gross Weight (Packaged Weight): 1,2Kg

Dimensions (cm)

Im REFERENCES

- NA LUMLUC630XXOC NW

STELLA

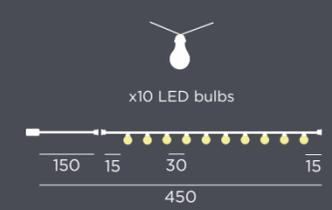

OPTIONS

- Solar + Rechargeable Battery | Indoor & outdoor use | Transparent cable 35
- Cable | Indoor & outdoor use | Transparent rope 35

Packaging Solar + Rechargeable Battery: 13 x 22 x 15 cm | Gross Weight (Packaged Weight): 0,6kg / Packaging Cable: 12 x 20 x 17 cm | Gross Weight (Packaged Weight): 0,4kg

Dimensions (cm)

Im REFERENCES

- 35 LUMGSTLSLNW
- 35 LUMGSTLOCNW

PORTABLE HANG

BENIRRÁS | NATURE COLLECTION



Dimensions (cm)

OPTIONS

- Rechargeable Battery | Indoor & outdoor use 90°

+ Cherry bulb included Packaging: 34,4 x 34,4 x 38,1 cm | Gross Weight (Packaged Weight): 0,9kg | String: 300cm

Im REFERENCES

- 90° LUMBEN035XXHXNW

BITA

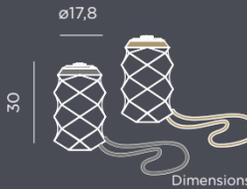

Dimensions (cm)

OPTIONS

- Rechargeable Battery | Indoor & outdoor use | Grey 300
- Rechargeable Battery | Indoor & outdoor use | Beige rope 300

Packaging: 18,5 x 18,5 x 29,5 cm | Gross Weight (Packaged Weight): 0,9kg | String: 150cm

Im REFERENCES

- 300 LUMBITAWLNW
- 300 LUMBITAB030WLNW

BOSSA HANG | NATURE COLLECTION



Dimensions (cm)

OPTIONS

- Rechargeable Battery | Indoor & outdoor use 90°

+ Cherry bulb included Packaging: 38,4 x 38,4 x 19,8 cm | Gross Weight (Packaged Weight): 1,5kg | String: 300cm

Im REFERENCES

- 90° LUMBOHXNW

CALOBRA HANG | NATURE COLLECTION



Dimensions (cm)

OPTIONS

- Rechargeable Battery | Indoor & outdoor use 90°

+ Cherry bulb included Packaging: 38,4 x 38,4 x 19,8 cm | Gross Weight (Packaged Weight): 1,5kg | String: 300cm

Im REFERENCES

- 90° LUMCAHXNW

CHIARA

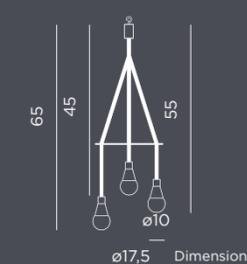

Dimensions (cm)

OPTIONS

- Solar & Rechargeable Battery | Indoor & outdoor use | Black colour 200x3

Packaging: 23,5 x 21,5 x 19 cm | Gross Weight (Packaged Weight): 0,7kg

Im REFERENCES

- 200x3 LUMCHI065BXS WNW

GLOSSARY This technical catalogue is subject to periodic updates, the measurements or finishes may vary in future revisions.

White light (included) Warm light (included) RGB light (included) Warm light portable rechargeable battery (included) Led tube lighting (included) Led light flame effect Twilight sensor Motion sensor Electric charge (driver not included) Remote control (included) Dimmable Hanging product Floating, not submersible Integrated speakers Touch control Volumen of the plantation area IP Indicates the level of protection of the electrical or electronic equipment against the entry of external agents: dust or water Made of recyclable materials Artificial plants included

GLOSSARY This technical catalogue is subject to periodic updates, the measurements or finishes may vary in future revisions.

White light (included) Warm light (included) RGB light (included) Warm light portable rechargeable battery (included) Led tube lighting (included) Led light flame effect Twilight sensor Motion sensor Electric charge (driver not included) Remote control (included) Dimmable Hanging product Floating, not submersible Integrated speakers Touch control Volumen of the plantation area IP Indicates the level of protection of the electrical or electronic equipment against the entry of external agents: dust or water Made of recyclable materials Artificial plants included

EDY A100



OPTIONS

Rechargeable Battery | Indoor & outdoor use | Black Colour

Im REFERENCES

IP54 400 LUMEDY100NXWLNW

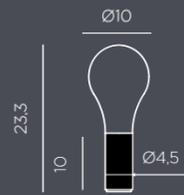

Dimensions (cm)

Packaging: ø10,2 x 27 cm | Gross Weight (Packaged Weight): 0,4 kg | Magnetic surface.

EDY G125



OPTIONS

Rechargeable Battery | Indoor & outdoor use | Black Colour
 Rechargeable Battery | Indoor & outdoor use | White Colour
 Rechargeable Battery | Indoor & outdoor use | Beige Colour

Im REFERENCES

IP54 400 LUMEDY125NXWLNW
 IP54 400 LUMEDY125BXWLNW
 IP54 400 LUMEDY125BEWLNW

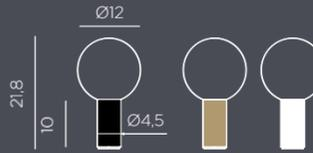

Dimensions (cm)

Packaging: 23 x 13,2 x 13,2 cm | Gross Weight (Packaged Weight): 0,4kg | Magnetic surface.

ELBA 59

OPTIONS

Rechargeable Battery | Indoor & outdoor use

Im REFERENCES

IP54 900 LUMELB059XXHWNW

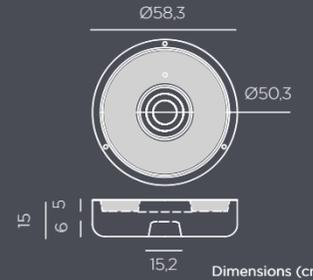

Dimensions (cm)

+ Cherry bulb included

Packaging: 15,5 x 59,5 x 59,5 cm | Gross Weight (Packaged Weight): 4,8kg | Artificial plants included

ELBA 39

OPTIONS

Rechargeable Battery | Indoor & outdoor use

Im REFERENCES

IP54 900 LUMELB039XXHWNW

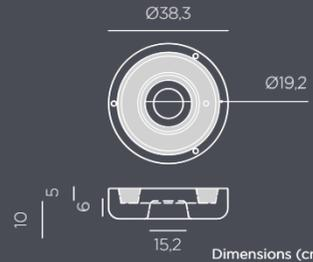

Dimensions (cm)

+ Cherry bulb included

Packaging: 12 x 39,5 x 46,5 cm | Gross Weight (Packaged Weight): 2,8kg | Artificial plants included

ILARIA | NATURE COLLECTION

OPTIONS

Solar & Rechargeable Battery Hang | Indoor & outdoor use

Im REFERENCES

IP54 200x3 LUMILA180XSXWNW

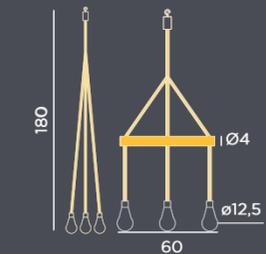

Dimensions (cm)

Packaging: 15 x 61 x 15 cm | Gross Weight (Packaged Weight): 2kg | Jute cable

NORAI

OPTIONS

Rechargeable Battery | Indoor & outdoor use | Grey
 Rechargeable Battery | Indoor & outdoor use | Beige rope

Im REFERENCES

IP65 300 LUMNR025WLNW
 IP65 300 LUMNRB025WLNW



Dimensions (cm)

Packaging: 24,6 x 24,6 x 24,6 cm | Gross Weight (Packaged Weight): 0,9kg | String: 150cm

PIANETA 25

OPTIONS

Rechargeable Battery | Indoor & outdoor use
 Hanging Cable | Indoor & outdoor use

Im REFERENCES

IP65 700 LUMPIA025XXHWNW
 IP44 460 LUMPIA025XXHBNW

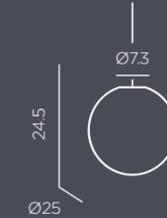

Dimensions (cm)

Packaging: 26 x 26 x 26 cm | Gross Weight (Packaged Weight): 1,2kg | Steel string

PIANETA 35

OPTIONS

Rechargeable Battery | Indoor & outdoor use
 Hanging Cable | Indoor & outdoor use

Im REFERENCES

IP65 700 LUMPIA035XXHWNW
 IP44 460 LUMPIA035XXHBNW



Dimensions (cm)

Packaging: 36 x 36 x 36 cm | Gross Weight (Packaged Weight): 1,7kg | Steel string

PIANETA 45

OPTIONS

Rechargeable Battery | Indoor & outdoor use
 Hanging Cable | Indoor & outdoor use

Im REFERENCES

IP65 700 LUMPIA045XXHWNW
 IP44 460 LUMPIA045XXHBNW



Dimensions (cm)

Packaging: 46 x 46 x 46 cm | Gross Weight (Packaged Weight): 2,9 Kg | Steel string

POSITANO | NATURE COLLECTION

OPTIONS

Rechargeable Battery | Indoor & outdoor use

Im REFERENCES

IP54 900 LUMPOS035XXHWNW

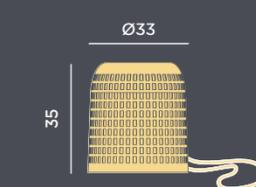

Dimensions (cm)

+ Cherry bulb included

Packaging: 34,4 x 34,4 x 38,1 cm | Gross Weight (Packaged Weight): 0,8kg | String: 300cm

GLOSSARY This technical catalogue is subject to periodic updates, the measurements or finishes may vary in future revisions.

☀️ White light (included) ☀️ Warm light (included) 🌈 RGB light (included) 🔋 Warm light portable rechargeable battery (included) 📡 Led tube lighting (included) 🔥 Led light flame effect 🌙 Twilight sensor 🕒 Motion sensor 🔌 Electric charge (driver not included) 📶 Remote control (included) 📶 Dimmable 🏠 Hanging product 🚤 Floating, not submersible 🗣️ Integrated speakers 🖱️ Touch control 🌊 Volumen of the plantation area **IP** Indicates the level of protection of the electrical or electronic equipment against the entry of external agents: dust or water ♻️ Made of recyclable materials 🌿 Artificial plants included

GLOSSARY This technical catalogue is subject to periodic updates, the measurements or finishes may vary in future revisions.

☀️ White light (included) ☀️ Warm light (included) 🌈 RGB light (included) 🔋 Warm light portable rechargeable battery (included) 📡 Led tube lighting (included) 🔥 Led light flame effect 🌙 Twilight sensor 🕒 Motion sensor 🔌 Electric charge (driver not included) 📶 Remote control (included) 📶 Dimmable 🏠 Hanging product 🚤 Floating, not submersible 🗣️ Integrated speakers 🖱️ Touch control 🌊 Volumen of the plantation area **IP** Indicates the level of protection of the electrical or electronic equipment against the entry of external agents: dust or water ♻️ Made of recyclable materials 🌿 Artificial plants included

REONA | NATURE COLLECTION

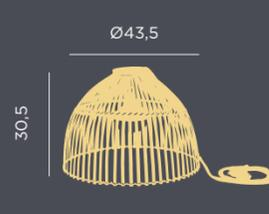

OPTIONS

- Rechargeable Battery | Indoor & outdoor use
- Cherry bulb included

Packaging: 31,65 x 43 x 43 cm | Gross Weight (Packaged Weight): 1,8kg | String: 300cm

Dimensions (cm)

Im REFERENCES

900 LUMREHXNW

SAONA HANG | NATURE COLLECTION



OPTIONS

- Rechargeable Battery | Indoor & outdoor use
- Cherry bulb included

Packaging: 32,8 x 32,8 x 51,5 cm | Gross Weight (Packaged Weight): 1,1kg | String: 300cm

Dimensions (cm)

Im REFERENCES

900 LUMSAO050XXHXNW

SIMONA | NATURE COLLECTION

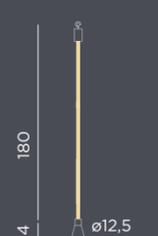

OPTIONS

- Solar & Rechargeable Battery Hang | Indoor & outdoor use

Packaging: 13,5 x 27 x 19,5 cm | Gross Weight (Packaged Weight): 0,6kg | Jute cable

Dimensions (cm)

Im REFERENCES

200 LUMSIM180XXSWNW

SISINE HANG | NATURE COLLECTION

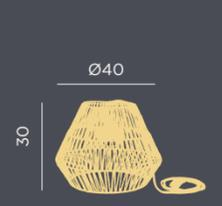

OPTIONS

- Rechargeable Battery | Indoor & outdoor use
- Cherry bulb included

Packaging: 31,65 x 43 x 43 cm | Gross Weight (Packaged Weight): 1,8kg | String: 300cm

Dimensions (cm)

Im REFERENCES

900 LUMSIHXNW

SORA



OPTIONS

- Rechargeable Battery | Indoor & outdoor use | Anthracite
- Rechargeable Battery | Indoor & outdoor use | Beige rope

Packaging: 24,6 x 24,6 x 24,6 cm | Gross Weight (Packaged Weight): 0,9kg | String: 150cm

Dimensions (cm)

Im REFERENCES

300 LUMSORAWLNW
300 LUMSORABWLNW

GLOSSARY This technical catalogue is subject to periodic updates, the measurements or finishes may vary in future revisions.

White light (included) Warm light (included) RGB light (included) Warm light portable rechargeable battery (included) Led tube lighting (included) Led light flame effect Twilight sensor Motion sensor Electric charge (driver not included) Remote control (included) Dimmable Hanging product Floating, not submersible Integrated speakers Touch control Volumen of the plantation area IP Indicates the level of protection of the electrical or electronic equipment against the entry of external agents: dust or water Made of recyclable materials Artificial plants included

TABLE LAMPS

BOSSA 30 | NATURE COLLECTION

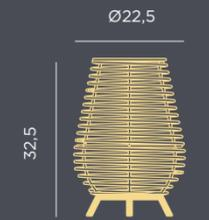

OPTIONS

- Rechargeable Battery | Indoor & outdoor use
- Cherry bulb included

Packaging: 27 x 27 x 40 cm | Gross Weight (Packaged Weight): 1,1kg

Dimensions (cm)

Im REFERENCES

900 LUMBOS030XXWLNW

CANDY BULB BATTERY

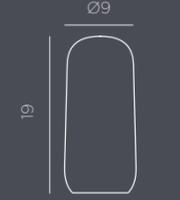

OPTIONS

- Rechargeable Battery | Indoor & outdoor use

Packaging: 20,5 x 9,2 x 9,2 cm | Gross Weight (Packaged Weight): 0,32kg | Magnetic surface.

Dimensions (cm)

Im REFERENCES

200 LUMCND019BXWLNW

CARMEN 45



OPTIONS

- Rechargeable Battery | Indoor & outdoor use
- Cable | Indoor use

Packaging: 30,2 x 30,2 x 46,5 cm | Gross Weight (Packaged Weight): 2,3kg

Dimensions (cm)

Im REFERENCES

315 LUMCR045WLNW
600 LUMCR045ICNW

CHLOE 35



OPTIONS

- Solar & Rechargeable Battery | Indoor & outdoor use
- Cable Jute | IN&OUT Indoor & outdoor use

Packaging: 28,3 x 28,3 x 18 cm | Gross Weight (Packaged Weight): 1,8kg

Dimensions (cm)

Im REFERENCES

45 LUMCHL035SSNW
500 LUMCHL035CCNW

ENOKI



OPTIONS

- Rechargeable Battery | Indoor & outdoor use | White colour
- Rechargeable Battery | Indoor & outdoor use | Black colour

Packaging: 17 x 18,5 x 28 cm | Gross Weight (Packaged Weight): 1,1kg

Dimensions (cm)

Im REFERENCES

170 LUMEN025BWLNW
170 LUMEN025NWLNW

GLOSSARY This technical catalogue is subject to periodic updates, the measurements or finishes may vary in future revisions.

White light (included) Warm light (included) RGB light (included) Warm light portable rechargeable battery (included) Led tube lighting (included) Led light flame effect Twilight sensor Motion sensor Electric charge (driver not included) Remote control (included) Dimmable Hanging product Floating, not submersible Integrated speakers Touch control Volumen of the plantation area IP Indicates the level of protection of the electrical or electronic equipment against the entry of external agents: dust or water Made of recyclable materials Artificial plants included

LOLA 20



Dimensions (cm)

OPTIONS

- Rechargeable Battery | Indoor & outdoor use  IP43 
- *AAA Batteries | Indoor & outdoor use  IP20 

* 3 AAA Batteries no supplies / Only smooth change colour mode

Packaging: 10,6 x 10,6 x 20,6 cm | Gross Weight (Packaged Weight): 0,3kg

Im REFERENCES

- 18 LUMLLO20WLNW
- 8 LUMLL20AAANW

LOLA 20 LUX



Dimensions (cm)

OPTIONS

- Rechargeable Battery | Indoor & outdoor use  IP43 

Packaging: 11,5 x 11,5 x 20,8 cm | Gross Weight (Packaged Weight): 0,3kg

Im REFERENCES

- 90 LUMLOL020XXWLNW

LOLA 30



Dimensions (cm)

OPTIONS

- Rechargeable Battery | Indoor & outdoor use  IP65 

Packaging: 17 x 17 x 31,6 cm | Gross Weight (Packaged Weight): 1,2kg

Im REFERENCES

- 315 LUMLLO30WLNW

LOLA 45



Dimensions (cm)

OPTIONS

- Rechargeable Battery | Indoor & outdoor use  IP65 
- Cable | Indoor & outdoor use  IP65

Packaging: 26 x 26 x 48 cm | Gross Weight (Packaged Weight): 1,7kg

Im REFERENCES

- 360 LUMLLO45WLNW
- 600 LUMLLO45OFNW

LOLA SLIM 30



Dimensions (cm)

OPTIONS

- Rechargeable Battery | Indoor & outdoor use | Anthracite colour  IP44 
- Rechargeable Battery | Indoor & outdoor use | Mint colour  IP44 
- Rechargeable Battery | Indoor & outdoor use | Brass colour  IP44 
- Rechargeable Battery | Indoor & outdoor use | Rose gold colour  IP44 
- Rechargeable Battery | Indoor & outdoor use | Space grey colour  IP44 
- Rechargeable Battery | Indoor & outdoor use | Lime colour  IP44 
- Rechargeable Battery | Indoor & outdoor use | White colour  IP44 

Packaging: 11,5 x 11,5 x 33,5 cm | Gross Weight (Packaged Weight): 0,9kg

Im REFERENCES

- 160 LUMLLS030ANWLNW
- 160 LUMLLS030MNWLNW
- 160 LUMLLS030BRWLNW
- 160 LUMLLS030RGWLNW
- 160 LUMLLS030GEWLNW
- 160 LUMLLS030LIWLNW
- 160 LUMLLS030BXWLNW

NORAI SLIM 35

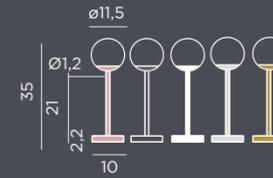

Dimensions (cm)

OPTIONS

- Rechargeable Battery | Indoor & outdoor use | Anthracite colour  IP44 
- Rechargeable Battery | Indoor & outdoor use | Brass colour  IP44 
- Rechargeable Battery | Indoor & outdoor use | Rose gold colour  IP44 
- Rechargeable Battery | Indoor & outdoor use | Space grey colour  IP44 
- Rechargeable Battery | Indoor & outdoor use | White colour  IP44 

Packaging: 35 x 11,5 x 11,5 cm | Gross Weight (Packaged Weight): 0,6kg

Im REFERENCES

- 160 LUMNRS035ANWLNW
- 160 LUMNRS035BRWLNW
- 160 LUMNRS035RGWLNW
- 160 LUMNRS035GEWLNW
- 160 LUMNRS035BXWLNW

PANCHITO

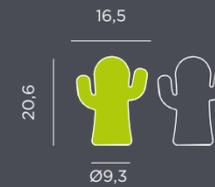

Dimensions (cm)

OPTIONS

- Rechargeable Battery | Indoor & outdoor use  IP43 
- Rechargeable Battery | Indoor & outdoor use | Lime colour  IP43 

Packaging: 15,6 x 10 x 21,5 cm | Gross Weight (Packaged Weight): 0,3kg.

Im REFERENCES

- 11 LUMPCT20WLNW
- 11 LUMPCT20VWLNW

ROCKET 20



Dimensions (cm)

OPTIONS

- Rechargeable Battery | Indoor & outdoor use  IP43 

Packaging: 13,5 x 13,5 x 14,5 cm | Gross Weight (Packaged Weight): 0,35kg.

Im REFERENCES

- 11 LUMRCK20WLNW

SAONA 30 | NATURE COLLECTION

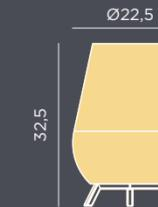

Dimensions (cm)

OPTIONS

- Rechargeable Battery | Indoor & outdoor use  IP54 

+ Cherry bulb included

Packaging: 27 x 27 x 40 cm | Gross Weight (Packaged Weight): 1,8kg

Im REFERENCES

- 900 LUMSAO030XXWLNW

SISINE 30 | NATURE COLLECTION

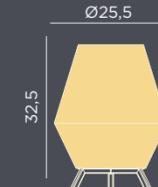

Dimensions (cm)

OPTIONS

- Rechargeable Battery | Indoor & outdoor use  IP54 

+ Cherry bulb included

Packaging: 27 x 27 x 40 cm | Gross Weight (Packaged Weight): 1,3kg

Im REFERENCES

- 900 LUMSIS030XXWLNW

GLOSSARY This technical catalogue is subject to periodic updates, the measurements or finishes may vary in future revisions.

 White light (included)  Warm light (included)  RGB light (included)  Warm light portable rechargeable battery (included)  Led tube lighting (included)  Led light flame effect  Twilight sensor  Motion sensor  Electric charge (driver not included)  Remote control (included)  Dimmable  Hanging product  Floating, not submersible  Integrated speakers  Touch control  Volumen of the plantation area **IP** Indicates the level of protection of the electrical or electronic equipment against the entry of external agents: dust or water  Made of recyclable materials  Artificial plants included

GLOSSARY This technical catalogue is subject to periodic updates, the measurements or finishes may vary in future revisions.

 White light (included)  Warm light (included)  RGB light (included)  Warm light portable rechargeable battery (included)  Led tube lighting (included)  Led light flame effect  Twilight sensor  Motion sensor  Electric charge (driver not included)  Remote control (included)  Dimmable  Hanging product  Floating, not submersible  Integrated speakers  Touch control  Volumen of the plantation area **IP** Indicates the level of protection of the electrical or electronic equipment against the entry of external agents: dust or water  Made of recyclable materials  Artificial plants included

SPEAKERS

CUBY 45 PLAY



OPTIONS

Rechargeable Battery | Play: Light & Music | Indoor & outdoor use | IP43 | 45

Packaging: 43,5 x 43,5 x 45 cm | Gross Weight (Packaged Weight): 5kg | x2 Speakers

Im REFERENCES

LUMCBP45WLNW

KURBY 38 PLAY



Dimensions (cm)

OPTIONS

Rechargeable Battery | Play: Light & Music | Indoor & outdoor use | IP43 | 45

Packaging: 37 x 27,5 x 27,5 cm | Gross Weight (Packaged Weight): 1,8kg | Vegan leather handle | x1 Speaker

Im REFERENCES

LUMKR038PLNW

NÓMADA 30 PLAY

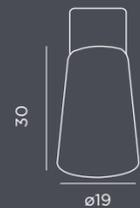

Dimensions (cm)

OPTIONS

Rechargeable Battery | Play: Light & Music | Indoor & outdoor use | IP43 | 45

Packaging: 20 x 20 x 31 cm | Gross Weight (Packaged Weight): 1,3kg | Metal handle | x1 Speaker

Im REFERENCES

LUMNM032PLNW

FUNCTIONAL

BOSSA WALL | NATURE COLLECTION

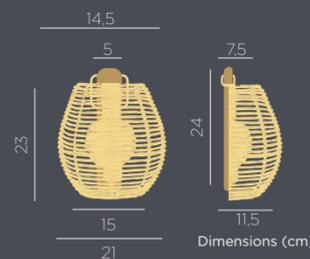

Dimensions (cm)

OPTIONS

Rechargeable Battery | Indoor & outdoor use | IP54 | 900

+ Cherry bulb included

Packaging: 16,3 x 21,2 x 27,2 cm | Gross Weight (Packaged Weight): 1kg

Im REFERENCES

LUMBOS025XXWLNW

BULY 20 WALL

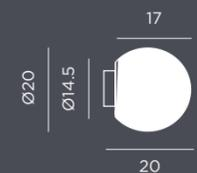

Dimensions (cm)

OPTIONS

Wall Cable | Indoor & outdoor use | IP44

Packaging: 20,6 x 20,6 x 22,3 cm | Gross Weight (Packaged Weight): 1kg | Installation required.

Im REFERENCES

LUMBL020OPNW

BRUNA 80 x1

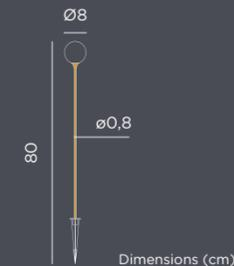

Dimensions (cm)

OPTIONS

Solar & Rechargeable Battery | Indoor & outdoor use | Brass colour | IP65

Packaging: 12,8 x 12,8 x 76 cm | Gross Weight (Packaged Weight): 0,6kg.

Im REFERENCES

38 LUMBRU081BRSWNW

BRUNA 80 x3

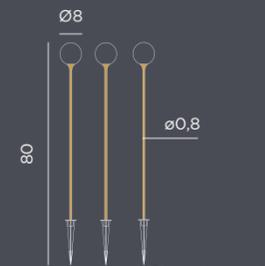

Dimensions (cm)

OPTIONS

Solar & Rechargeable Battery | Indoor & outdoor use | Brass colour | IP65

Packaging: 12,8 x 20,8 x 76 cm | Gross Weight (Packaged Weight): 1kg.

Im REFERENCES

115 LUMBRU080BRSWNW

CHERRY BULB

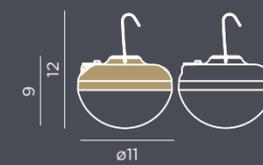

Dimensions (cm)

OPTIONS

Rechargeable Battery | Indoor & outdoor use | White colour. | IP54 | 900
Rechargeable Battery | Indoor & outdoor use | Beige colour. | IP54 | 900

Packaging: 11,5 x 11 x 9 cm | Gross Weight (Packaged Weight): 0,3kg | Magnetic surface.

Im REFERENCES

LUMCHE011BXWLNW
LUMCHE011BEWLNW

SOLAR CHERRY BULB

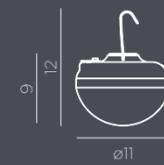

Dimensions (cm)

OPTIONS

Solar + Rechargeable Battery | Indoor & outdoor use | White colour. | IP54 | 900



Packaging: 13,2 x 13,2 x 10 cm | Gross Weight (Packaged Weight): 0,65kg | Magnetic surface.

Im REFERENCES

LUMCHS011BXWLNW

CLAUDY HANG

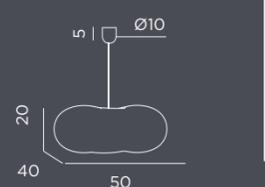

Dimensions (cm)

OPTIONS

Hanging Cable | Indoor & outdoor use | IP44

Packaging: 39,5 x 50,3 x 20 cm | Gross Weight (Packaged Weight): 2,3kg | Cable: 1,5m | Installation required.

Im REFERENCES

LUMCLO50HXNW

GLOSSARY This technical catalogue is subject to periodic updates, the measurements or finishes may vary in future revisions.

☀️ White light (included) 🔦 Warm light (included) 🌈 RGB light (included) 🔋 Warm light portable rechargeable battery (included) 📡 Led tube lighting (included) 🔥 Led light flame effect 🌙 Twilight sensor 📡 Motion sensor 🔌 Electric charge (driver not included) 📡 Remote control (included) 📡 Dimmable 📡 Hanging product 📡 Floating, not submersible 📡 Integrated speakers 📡 Touch control 📡 Volumen of the plantation area IP Indicates the level of protection of the electrical or electronic equipment against the entry of external agents: dust or water ♻️ Made of recyclable materials 🌿 Artificial plants included

GLOSSARY This technical catalogue is subject to periodic updates, the measurements or finishes may vary in future revisions.

☀️ White light (included) 🔦 Warm light (included) 🌈 RGB light (included) 🔋 Warm light portable rechargeable battery (included) 📡 Led tube lighting (included) 🔥 Led light flame effect 🌙 Twilight sensor 📡 Motion sensor 🔌 Electric charge (driver not included) 📡 Remote control (included) 📡 Dimmable 📡 Hanging product 📡 Floating, not submersible 📡 Integrated speakers 📡 Touch control 📡 Volumen of the plantation area IP Indicates the level of protection of the electrical or electronic equipment against the entry of external agents: dust or water ♻️ Made of recyclable materials 🌿 Artificial plants included

GRETA



Dimensions (cm)

OPTIONS

- Solar & Rechargeable Battery | Indoor & outdoor use | ● White colour
- Solar & Rechargeable Battery | Indoor & outdoor use | ○ Black colour

Packaging: 23,5 x 22 x 16,5 cm | Gross Weight (Packaged Weight): 0,7kg | Recycled plastic

Im

REFERENCES

- 100 LUMGRE080BXSWNW
- 100 LUMGRE080NXSWNW

GRETITA



Dimensions (cm)

OPTIONS

- Solar | Outdoor use | ○ Black colour
- Solar | Outdoor use | ● White colour

Packaging: 10 x 37 x 12 cm | Gross Weight (Packaged Weight): 0,6kg

Im

REFERENCES

- 4 LUMGRT039NXSLNW
- 4 LUMGRT039BXSLSNW

HIAMA | NATURE COLLECTION

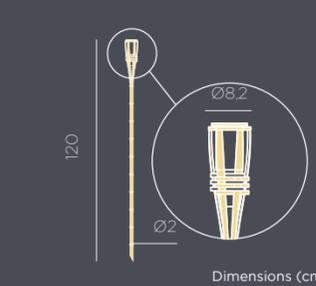

Dimensions (cm)

OPTIONS

- Solar | Outdoor use

Box Packaging: 122 x 52 x 19 cm | Gross Weight (Packaged Weight): 5,25kg (0,19kg = 1ud)

Im

REFERENCES

- 25 LUMHIA120XXSLNW

LOLA 35 WALL



Dimensions (cm)

OPTIONS

- Wall Cable | Indoor & outdoor use

Packaging: 20,3x 36 x 36,5 cm | Gross Weight (Packaged Weight): 1,6kg | Installation required.

Im

REFERENCES

- LUMLL035OPNW

PAQUITA 40



Dimensions (cm)

OPTIONS

- Solar | Outdoor use | ○ Anthracite colour.

Packaging: 15,2 x 40,3 x 32,5 cm | Gross Weight (Packaged Weight): 2,4kg

Im

REFERENCES

- 600 LUMPQTSMNLNW

PAQUITA 215 FAROLA

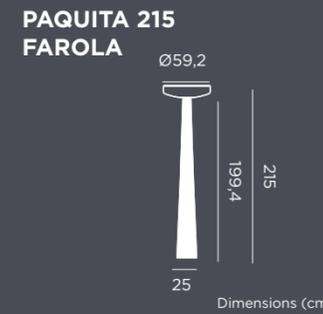

Dimensions (cm)

OPTIONS

- Solar | Outdoor use | ○ Anthracite colour.

Packaging: 42,5 x 59,3 x 105 cm | Gross Weight (Packaged Weight): 12,8kg

Im

REFERENCES

- 1.200 LUMPQTFARSLNW

PAQUITA WALL



Dimensions (cm)

OPTIONS

- Solar | Outdoor use | ○ Anthracite colour.

Packaging: 22,3 x 29,7 x 29,8 cm | Gross Weight (Packaged Weight): 1,8kg

Im

REFERENCES

- 600 LUMPQTAPLSLNW

PEPITA 45

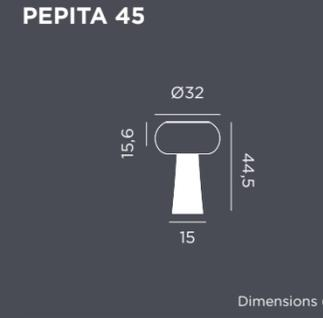

Dimensions (cm)

OPTIONS

- Cable & Solar (Hibryd) | Outdoor use | ○ Anthracite colour.

Packaging: 36 x 54 x 32,5 cm | Gross Weight (Packaged Weight): 2,5kg | Installation required.

Im

REFERENCES

- 750 LUMPEP045ANSHNW

PEPITA 215 FAROLA

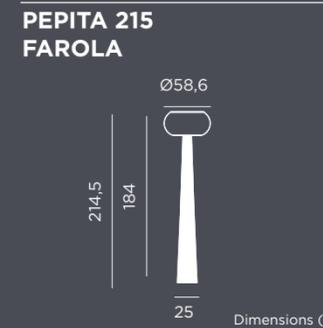

Dimensions (cm)

OPTIONS

- Cable & Solar (Hibryd) | Outdoor use | ○ Anthracite colour.

Packaging: 57 x 59,3 x 105 cm | Gross Weight (Packaged Weight): 13kg | Installation required.

Im

REFERENCES

- 1.500 LUMPEP215ANSHNW

PEPITA WALL

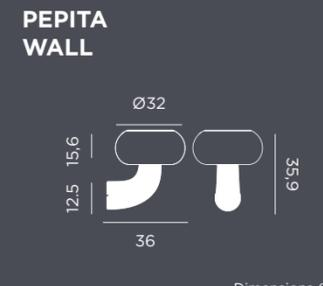

Dimensions (cm)

OPTIONS

- Cable & Solar (Hibryd) | Outdoor use | ○ Anthracite colour.

Packaging: 18,3 x 46,6 x 32,5 cm | Gross Weight (Packaged Weight): 2,5kg | Installation required.

Im

REFERENCES

- 750 LUMPEP036ANOPNW

GLOSSARY This technical catalogue is subject to periodic updates, the measurements or finishes may vary in future revisions.

☀ White light (included) ☀ Warm light (included) ☀ RGB light (included) 🔋 Warm light portable rechargeable battery (included) 📡 Led tube lighting (included) 🔥 Led light flame effect 🌙 Twilight sensor 🏠 Motion sensor 🏠 Electric charge (driver not included) 📡 Remote control (included) 📡 Dimmable 📡 Hanging product 🏠 Floating, not submersible 📡 Integrated speakers 📡 Touch control 📡 Volumen of the plantation area **IP** Indicates the level of protection of the electrical or electronic equipment against the entry of external agents: dust or water ♻ Made of recyclable materials 🌿 Artificial plants included

GLOSSARY This technical catalogue is subject to periodic updates, the measurements or finishes may vary in future revisions.

☀ White light (included) ☀ Warm light (included) ☀ RGB light (included) 🔋 Warm light portable rechargeable battery (included) 📡 Led tube lighting (included) 🔥 Led light flame effect 🌙 Twilight sensor 🏠 Motion sensor 🏠 Electric charge (driver not included) 📡 Remote control (included) 📡 Dimmable 📡 Hanging product 🏠 Floating, not submersible 📡 Integrated speakers 📡 Touch control 📡 Volumen of the plantation area **IP** Indicates the level of protection of the electrical or electronic equipment against the entry of external agents: dust or water ♻ Made of recyclable materials 🌿 Artificial plants included

PETRA 40 HANG

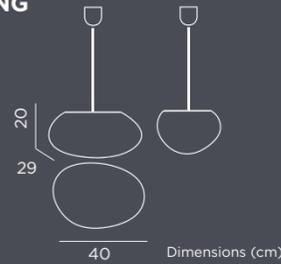

OPTIONS

Hanging Cable | Indoor & outdoor use  -

Packaging: 40,3 x 29,5 x 20,5 cm | Gross Weight (Packaged Weight): 1,5kg | Metal trim | Cable: 1,5m | Installation required.

Im REFERENCES
LUMPT040HXNW

PETRA 60 HANG

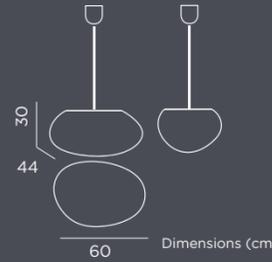

OPTIONS

Hanging Cable | Indoor & outdoor use  -

Packaging: 44,3 x 60,2 x 30,8 cm | Gross Weight (Packaged Weight): 2,5kg | Metal trim | Cable: 1,5m | Installation required.

Im REFERENCES
LUMPT060HXNW

SAONA WALL | NATURE COLLECTION

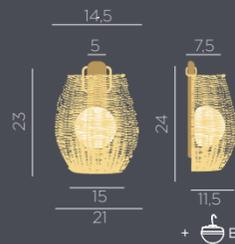

OPTIONS

Rechargeable Battery | Indoor & outdoor use    900

+  Cherry bulb included

Packaging: 16,3 x 21,2 x 27,2 cm | Gross Weight (Packaged Weight): 1kg

+  Beige Cherry

Im REFERENCES
LUMSAO025XXWLNW

SISINE 25 | NATURE COLLECTION WALL

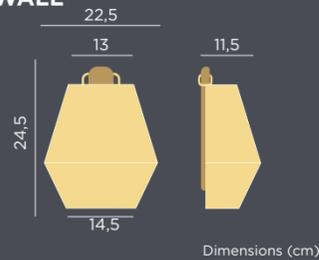

OPTIONS

Rechargeable Battery | Indoor & outdoor use    900

+  Cherry bulb included

Packaging: 27,2 x 21,2 x 16,3 cm | Gross Weight (Packaged Weight): 0,9kg

Im REFERENCES
LUMSIS025XXWLNW

WALLY SQUARE 12x12x12

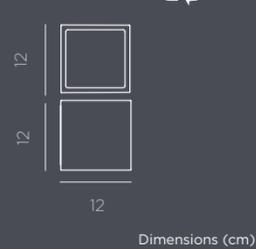

OPTIONS

Solar | Outdoor use |  White colour.     500

Packaging: 13,3 x 13,3 x 13,7 cm | Gross Weight (Packaged Weight): 0,4kg

Im REFERENCES
LUMWLC012XXSPNW

WALLY SQUARE 12x12x12

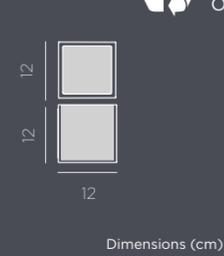

OPTIONS

White Opaque Colour 

Packaging: 13,3 x 13,3 x 13,7 cm | Gross Weight (Packaged Weight): 0,4kg | 1,5 L  Artificial plants included.

REFERENCES
JDNWAP012BXNLNW

WALLY RECTANGLE 12x12x18



OPTIONS

Solar | Outdoor use |  White colour.

Packaging: 13,3 x 13,3 x 19,7cm | Gross Weight (Packaged Weight): 0,6kg

    500 LUMWLP012XXSPNW

Im REFERENCES

WALLY SQUARE 18x18x18

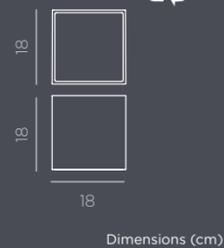

OPTIONS

Solar | Outdoor use |  White colour.

Packaging: 19,3 x 19,3 x 19,7cm | Gross Weight (Packaged Weight): 1kg

    1.000 LUMWLC018XXSPNW

Im REFERENCES

WALLY 27 DISK



OPTIONS

Solar | Outdoor use |  White colour.

Packaging: cm 28 x 28 x 6,5 cm | Gross Weight (Packaged Weight): 0,65 kg

    200 LUMWLD027XXSPNW

Im REFERENCES

WALLY 39 DISK



OPTIONS

Solar | Outdoor use |  White colour.

Packaging: 40 x 40 x 9,5 cm | Gross Weight (Packaged Weight): 1,5kg

    200 LUMWLD039XXSPNW

Im REFERENCES

GLOSSARY This technical catalogue is subject to periodic updates, the measurements or finishes may vary in future revisions.

 White light (included)  Warm light (included)  RGB light (included)  Warm light portable rechargeable battery (included)  Led tube lighting (included)  Led light flame effect  Twilight sensor  Motion sensor  Electric charge (driver not included)  Remote control (included)  Dimmable  Hanging product  Floating, not submersible  Integrated speakers  Touch control  Volumen of the plantation area **IP** Indicates the level of protection of the electrical or electronic equipment against the entry of external agents: dust or water  Made of recyclable materials  Artificial plants included

GLOSSARY This technical catalogue is subject to periodic updates, the measurements or finishes may vary in future revisions.

 White light (included)  Warm light (included)  RGB light (included)  Warm light portable rechargeable battery (included)  Led tube lighting (included)  Led light flame effect  Twilight sensor  Motion sensor  Electric charge (driver not included)  Remote control (included) Dimmable Hanging product Floating, not submersible Integrated speakers Touch control Volumen of the plantation area **IP** Indicates the level of protection of the electrical or electronic equipment against the entry of external agents: dust or water Made of recyclable materials Artificial plants included

ESSENTIALS

BULY 20



Dimensions (cm)

OPTIONS

	Solar & Rechargeable Battery Indoor & outdoor use		45	LUMBL020SSNW
	Solar Outdoor use (Floating)		45	LUMBL020FTNW
	Solar Outdoor use		16	LUMBL020SANW
	Cable Indoor & outdoor use		250	LUMBL020OFNW

Packaging: 19,5 x 20,3 x 20,3 cm | Gross Weight (Packaged Weight): 0,8kg.

BULY 80



Dimensions (cm)

OPTIONS

	Solar & Rechargeable Battery Indoor & outdoor use		600	LUMBL080SSNW
	Cable Indoor & outdoor use		600	LUMBL080OFNW

Packaging: 70,3 x 79,5 x 79,5 cm | Gross Weight (Packaged Weight): 9,5kg.

BULY 30



Dimensions (cm)

OPTIONS

	Solar & Rechargeable Battery Indoor & outdoor use		45	LUMBL030SSNW
	Solar Outdoor use (Floating)		45	LUMBL030FTNW
	Cable Indoor & outdoor use		600	LUMBL030OFNW

Packaging: 31,5 x 31,5 x 29 cm | Gross Weight (Packaged Weight): 1,2kg.

CUBY 20

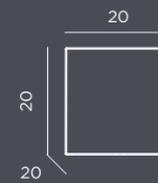

Dimensions (cm)

OPTIONS

	Solar & Rechargeable Battery Indoor & outdoor use		45	LUMCB020SSNW
	Cable Indoor & outdoor use		250	LUMCB020OFNW

Packaging: 26,5 x 30,3 x 30,3 cm | Gross Weight (Packaged Weight): 1,1kg.

BULY 40



Dimensions (cm)

OPTIONS

	Solar & Rechargeable Battery Indoor & outdoor use		45	LUMBL040SSNW
	Solar Outdoor use (Floating)		45	LUMBL040FTNW
	Cable Indoor & outdoor use		600	LUMBL040OFNW

Packaging: 36,6 x 40,3 x 40,3 cm | Gross Weight (Packaged Weight): 1,9kg.

CUBY 32

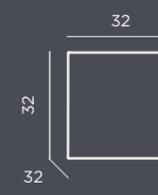

Dimensions (cm)

OPTIONS

	Solar & Rechargeable Battery Indoor & outdoor use		45	LUMCB032SSNW
	Cable Indoor & outdoor use		600	LUMCB032OFNW

Packaging: 34,8 x 32,5 x 32,5 cm | Gross Weight (Packaged Weight): 2,7kg.

BULY 50



Dimensions (cm)

OPTIONS

	Solar & Rechargeable Battery Indoor & outdoor use		45	LUMBL050SSNW
	Cable Indoor & outdoor use		600	LUMBL050OFNW

Packaging: 44,5 x 50,5 x 50,5 cm | Gross Weight (Packaged Weight): 3,2kg.

CUBY 40

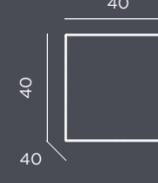

Dimensions (cm)

OPTIONS

	Solar & Rechargeable Battery Indoor & outdoor use		45	LUMCB040SSNW
	Cable Indoor & outdoor use		600	LUMCB040OFNW

Packaging: 46,6 x 46,6 x 42 cm | Gross Weight (Packaged Weight): 4kg.

BULY 60



Dimensions (cm)

OPTIONS

	Solar & Rechargeable Battery Indoor & outdoor use		45	LUMBL060SSNW
	Cable Indoor & outdoor use		600	LUMBL060OFNW

Packaging: 56 x 59,5 x 59,5 cm | Gross Weight (Packaged Weight): 4,5kg.

CUBY 45

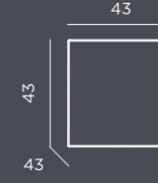

Dimensions (cm)

OPTIONS

	Solar & Rechargeable Battery Indoor & outdoor use		45	LUMCB045SSNW
	Cable Indoor & outdoor use		600	LUMCB045OFNW

Packaging: 45 x 43,5 x 43,5 cm | Gross Weight (Packaged Weight): 5kg.

GLOSSARY This technical catalogue is subject to periodic updates, the measurements or finishes may vary in future revisions.

White light (included) Warm light (included) RGB light (included) Warm light portable rechargeable battery (included) Led tube lighting (included) Led light flame effect Twilight sensor Motion sensor Electric charge (driver not included) Remote control (included) Dimmable Hanging product Floating, not submersible Integrated speakers Touch control Volumen of the plantation area **IP** Indicates the level of protection of the electrical or electronic equipment against the entry of external agents: dust or water Made of recyclable materials Artificial plants included

GLOSSARY This technical catalogue is subject to periodic updates, the measurements or finishes may vary in future revisions.

White light (included) Warm light (included) RGB light (included) Warm light portable rechargeable battery (included) Led tube lighting (included) Led light flame effect Twilight sensor Motion sensor Electric charge (driver not included) Remote control (included) Dimmable Hanging product Floating, not submersible Integrated speakers Touch control Volumen of the plantation area **IP** Indicates the level of protection of the electrical or electronic equipment against the entry of external agents: dust or water Made of recyclable materials Artificial plants included

CUBY 53



Dimensions (cm)

OPTIONS

- Solar & Rechargeable Battery | Indoor & outdoor use
- Cable | Indoor & outdoor use

Packaging: 43,6x 43,6 x 55 cm | Gross Weight (Packaged Weight): 5,5kg.

Im	REFERENCES
45	LUMCB053SSNW
600	LUMCB053OFNW

PETRA 40

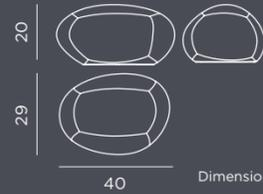

Dimensions (cm)

OPTIONS

- Solar & Rechargeable Battery | Indoor & outdoor use
- Solar | Outdoor use
- Cable | Indoor & outdoor use

Packaging: 20,5 x 40,3 x 29,5 cm | Gross Weight (Packaged Weight): 1,3kg.

Im	REFERENCES
45	LUMPT040SSNW
16	LUMPT040SANW
250	LUMPT040OFNW

PETRA 60

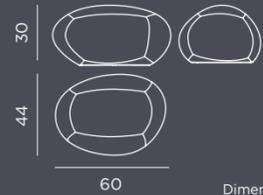

Dimensions (cm)

OPTIONS

- Solar & Rechargeable Battery | Indoor & outdoor use
- Cable | Indoor & outdoor use

Packaging: 44,3 x 60,2 x 30,8 cm | Gross Weight (Packaged Weight): 2,5kg.

Im	REFERENCES
45	LUMPT060SSNW
600	LUMPT060OFNW

TABLES P 222

SEATS P 225

BAR P 226

TABLES

BORA

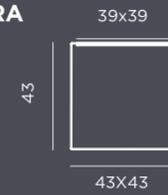

Dimensions (cm)

OPTIONS

- Cable Jute | IN&OUT Indoor & outdoor use | Marble
- Cable Jute | IN&OUT Indoor & outdoor use | Wood
- White Opaque Colour | Marble
- White Opaque Colour | Wood

Packaging: 44 x 44 x 45,5 cm | Gross Weight (Packaged Weight) Wood: 5,7 kg | Gross Weight (Packaged Weight) Marble: 8,2 kg

Im	REFERENCES
860	LUMBORAMBXINOUTNW
860	LUMBORAWBXINOUTNW
	LUMBORAMBXNW
	LUMBORAWBXNW

CUBY 45

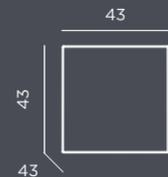

Dimensions (cm)

OPTIONS

- Solar & Rechargeable Battery | Indoor & outdoor use
- Cable | Indoor & outdoor use
- Rechargeable Battery | Play: Light & Music | Indoor & outdoor use

Packaging: 45 x 43,5 x 43,5 cm | Gross Weight (Packaged Weight): 5kg.

Im	REFERENCES
45	LUMCB045SSNW
600	LUMCB045OFNW
45	LUMCBP45WLNW

CUBY 53



Dimensions (cm)

OPTIONS

- Solar & Rechargeable Battery | Indoor & outdoor use
- Cable | Indoor & outdoor use

Packaging: 43,6x 43,6 x 55 cm | Gross Weight (Packaged Weight): 5,5kg.

Im	REFERENCES
45	LUMCB053SSNW
600	LUMCB053OFNW

CAPRI 40



Dimensions (cm)

OPTIONS

- Solar & Rechargeable Battery | Indoor & outdoor use
- White Opaque Colour

Packaging: 60 x 60 x 42 cm | Gross Weight (Packaged Weight): 4,5 kg | Methacrylate cover included.

Im	REFERENCES
45	MOBCP040SSNW
	MOBCP040BXNW

CAPRI 75



Dimensions (cm)

OPTIONS

- Solar & Rechargeable Battery | Indoor & outdoor use
- Cable | Indoor & outdoor use
- White Opaque Colour

Packaging: 74,4 x 100,6 x 101 cm | Gross Weight (Packaged Weight): 18 kg | Methacrylate cover included.

Im	REFERENCES
45	MOBCP075SSNW
600	MOBCP075OFNW
	MOBCP075BXNW

CAPRI 110



Dimensions (cm)

OPTIONS

- Rechargeable Battery | Indoor & outdoor use
- White Opaque Colour

Packaging: 60 x 60 x 113 cm | Gross Weight (Packaged Weight): 10 kg | Methacrylate cover included.

Im	REFERENCES
360	MOBCP110TWLNW
	MOBCP110BXNW

ITACA 60

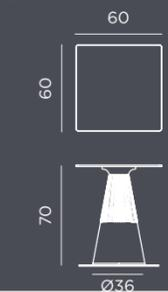

Dimensions (cm)

OPTIONS

- Solar & Rechargeable Battery | Indoor & outdoor use

Packaging: 35,5 x 35,5 x 70 cm | Gross Weight (Packaged Weight): 12,6kg | White phenolic cover included: unassembled; individual package (plastic bag). Weight stability included.

Im	REFERENCES
45	MOBITC60SSNW

GLOSSARY This technical catalogue is subject to periodic updates, the measurements or finishes may vary in future revisions.

White light (included) Warm light (included) RGB light (included) Warm light portable rechargeable battery (included) Led tube lighting (included) Led light flame effect Twilight sensor Motion sensor Electric charge (driver not included) Remote control (included) Dimmable Hanging product Floating, not submersible Integrated speakers Touch control Volumen of the plantation area IP Indicates the level of protection of the electrical or electronic equipment against the entry of external agents: dust or water Made of recyclable materials Artificial plants included

GLOSSARY This technical catalogue is subject to periodic updates, the measurements or finishes may vary in future revisions.

White light (included) Warm light (included) RGB light (included) Warm light portable rechargeable battery (included) Led tube lighting (included) Led light flame effect Twilight sensor Motion sensor Electric charge (driver not included) Remote control (included) Dimmable Hanging product Floating, not submersible Integrated speakers Touch control Volumen of the plantation area IP Indicates the level of protection of the electrical or electronic equipment against the entry of external agents: dust or water Made of recyclable materials Artificial plants included

MARTINICA



OPTIONS

- Solar & Rechargeable Battery | Indoor & outdoor use
- White Opaque Colour

Packaging: 82,5 x 101 x 36 cm | Gross Weight (Packaged Weight): 10kg

Im REFERENCES

- 45 MOBMESSASSNW
- MOBMESSABXNW

TARIDA TAB

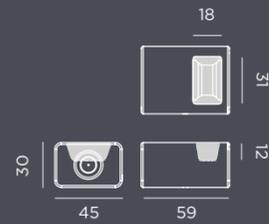

OPTIONS

- Solar & Rechargeable Battery | Indoor & outdoor use
- Rechargeable Battery | Play: Light & Music | Indoor & outdoor use
- White Opaque Colour

Dimensions (cm) Packaging: 45,6 x 59,6 x 31,5 cm | Gross Weight (Packaged Weight): 5kg | Methacrylate cover included. 3,5 L | Play Light & Music finished x2 Speakers.

Im REFERENCES

- 45 MOBTDT30SSNW
- 45 MOBTDT30PLNW
- MOBTDT30BXNW

SEATS

ARUBA

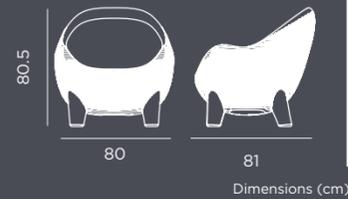

OPTIONS

- Solar & Rechargeable Battery | Indoor & outdoor use
- White Opaque Colour

Packaging: plastic bag | Gross Weight (Packaged Weight): 12kg

Im REFERENCES

- 45 MOBSILARSSNW
- MOBSILARBXNW

CORFU 40



OPTIONS

- Solar & Rechargeable Battery | Indoor & outdoor use
- White Opaque Colour

Packaging: 40,5 x 40,5 x 38 | Gross Weight (Packaged Weight): 3,5kg

Im REFERENCES

- 45 MOBFCF040SSNW
- MOBFCF040BXNW

CORFU 74



OPTIONS

- Solar & Rechargeable Battery | Indoor & outdoor use
- White Opaque Colour

Packaging: 40 x 40 x 74,8 cm | Gross Weight (Packaged Weight): 5,5kg

Im REFERENCES

- 45 MOBFCF074SSNW
- MOBFCF074BXNW

FORMENTERA

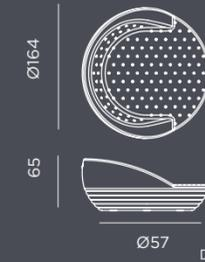

OPTIONS

- Solar & Rechargeable Battery | Indoor & outdoor use
- Cable | Indoor & outdoor use
- White Opaque Colour
- White Formentera mattress 140 x 112 x 8 cm
- White Formentera pillow 50 x 50 cm
- White Formentera pillow 60 x 40 cm

Packaging: Plastic bag | Gross Weight (Packaged Weight): 41kg (*)Lumens per bulb

Im REFERENCES

- *45x4 MOBFR160SSNW
- 600 MOBFR160OFNW
- MOBFR160BXNW
- MOBCNF140BXNLNW
- MOBCNC050BXNLNW
- MOBCNR060BXNLNW

JAMAICA

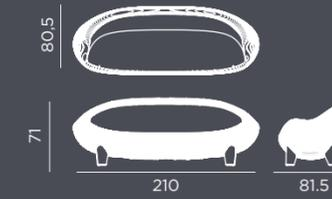

OPTIONS

- Solar & Rechargeable Battery | Indoor & outdoor use
- Cable | Indoor & outdoor use
- White Opaque Colour

Packaging: Plastic bag | Gross Weight (Packaged Weight): 30,5kg (*)Lumens per bulb

Im REFERENCES

- 45x2 MOBSOFJASSNW
- 600 MOBSOFJAOFNW
- MOBSOFJABXNW

MALLORCA

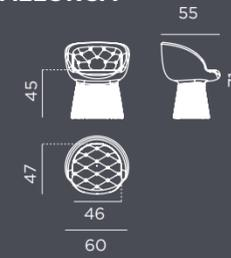

OPTIONS

- Solar & Rechargeable Battery | Indoor & outdoor use
- White Opaque Colour

Packaging: 60 x 60 x 73 cm | Gross Weight (Packaged Weight): 7,5kg

Im REFERENCES

- 45 MOBMA060SSNW
- MOBMA060BXNW

PUFY 45

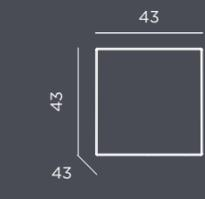

OPTIONS

- White Opaque Colour

Packaging: 45 x 43,5 x 43,5 cm | Gross Weight (Packaged Weight): 5kg.

REFERENCES

- MOBPF045BXNW

RASA

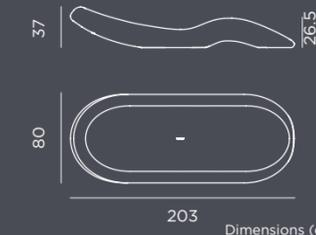

OPTIONS

- White Opaque Colour

Packaging: 35,5 x 204 x 80,5 cm | Gross Weight (Packaged Weight): 15kg

REFERENCES

- MOBRASABXNW

GLOSSARY This technical catalogue is subject to periodic updates, the measurements or finishes may vary in future revisions.

White light (included) Warm light (included) RGB light (included) Warm light portable rechargeable battery (included) Led tube lighting (included) Led light flame effect Twilight sensor Motion sensor Electric charge (driver not included) Remote control (included) Dimmable Hanging product Floating, not submersible Integrated speakers Touch control Volumen of the plantation area IP Indicates the level of protection of the electrical or electronic equipment against the entry of external agents: dust or water Made of recyclable materials Artificial plants included

GLOSSARY This technical catalogue is subject to periodic updates, the measurements or finishes may vary in future revisions.

White light (included) Warm light (included) RGB light (included) Warm light portable rechargeable battery (included) Led tube lighting (included) Led light flame effect Twilight sensor Motion sensor Electric charge (driver not included) Remote control (included) Dimmable Hanging product Floating, not submersible Integrated speakers Touch control Volumen of the plantation area IP Indicates the level of protection of the electrical or electronic equipment against the entry of external agents: dust or water Made of recyclable materials Artificial plants included

TAFY 38

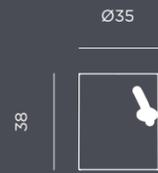

Dimensions (cm)

OPTIONS

- White Opaque Colour ●
- Black Opaque Colour ○

Packaging: 41,5 x 41,5 x 41 cm | Gross Weight (Packaged Weight): 2,8kg.

REFERENCES

- MOBTF038BXNW
- MOBTF038NXNW

TARIDA SIT

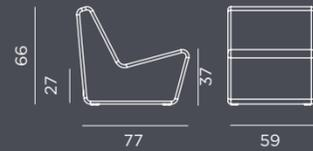

Dimensions (cm)

OPTIONS

- Solar & Rechargeable Battery | Indoor & outdoor use
- IP65
- Dimmable
- Twilight sensor

Packaging: 69 x 77 x 66,5 cm | Gross Weight (Packaged Weight): 8,5kg | Pillow included.

Im REFERENCES

- 600 MOBTD66SSNW

TARIDA SIT ARMS

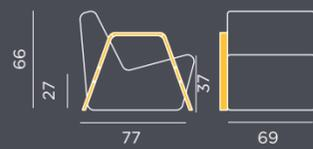

Dimensions (cm)

OPTIONS

- Solar & Rechargeable Battery | Indoor & outdoor use
- IP65
- Dimmable
- Twilight sensor

- White Opaque Colour ●

Packaging: 69 x 77 x 66,5 cm | Gross Weight (Packaged Weight): 14kg | Wood arms. | Pillow included.

Im REFERENCES

- 600 MOBTD66ARMSSNW
- MOBTD66ARMBXNW

BAR

COOLER

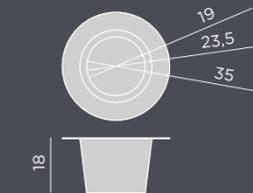

OPTIONS

- Bambu cooler | Indoor & outdoor use
- Palma cooler | Indoor & outdoor use

Packaging: 20,6x 20,6 x 22,3 cm | Gross Weight (Packaged Weight): 1kg | Made of aluminium.

REFERENCES

- LUMCLB035XXNLNW
- LUMCLP035XXNLNW

CRETA 120



Dimensions (cm)

OPTIONS

- Solar & Rechargeable Battery | Indoor & outdoor use
- IP65
- Dimmable
- Twilight sensor

- Cable | Indoor & outdoor use
- Shelf accessory 21 x 101 x 1cm

Packaging: 120 x 66 x 111,5 cm | Gross Weight (Packaged Weight): 27kg | Methacrylate cover included.

Im REFERENCES

- 45 MOBCR120SSNW
- 600 MOBCR120OFNW
- MOBCRE101BXNLNW

IBIZA 120



Dimensions (cm)

OPTIONS

- Solar & Rechargeable Battery | Indoor & outdoor use
- Cable | Indoor & outdoor use

Packaging: 120 x 66 x 111,5 cm | Gross Weight (Packaged Weight): 23,8kg | Methacrylate cover included.

Im REFERENCES

- 45 MOBBZ120SSNW
- 600 MOBBZ120OFNW

MILOS 160 | NATURE COLLECTION

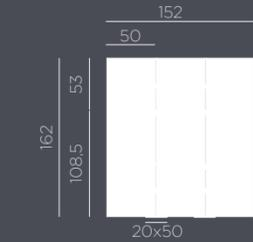

Dimensions (cm)

OPTIONS

- Indoor & outdoor use

Packaging: 109 x 50,5 x 6 cm | Gross Weight (Packaged Weight): 15kg

REFERENCES

- MOBMIL160XXNLNW

PALMA BOTTLE RACK



Dimensions (cm)

OPTIONS

- Solar & Rechargeable Battery | Indoor & outdoor use
- Palma cooler | Indoor & outdoor use

Packaging: 35,5 x 35,5 x 70 cm | Gross Weight (Packaged Weight): 5kg

Im REFERENCES

- 45 LUMPMB70SSNW
- LUMCLP035XXNLNW

SICILIA 75

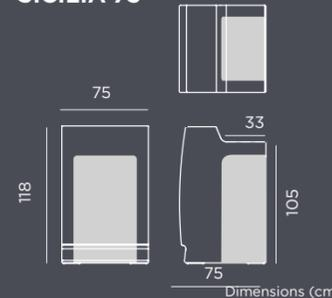

Dimensions (cm)

OPTIONS

- Solar & Rechargeable Battery | Indoor & outdoor use

Packaging: 75 x 76,5 x 118,5 cm | Gross Weight (Packaged Weight): 33kg | Methacrylate cover included.

Im REFERENCES

- 45 MOBSC075SSNW

SICILIA 120

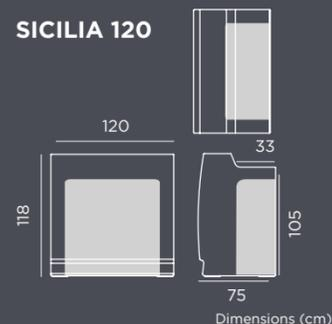

Dimensions (cm)

OPTIONS

- Solar & Rechargeable Battery | Indoor & outdoor use
- Cable | Indoor & outdoor use

- White Opaque Colour ●

Packaging: 120 x 76,5 x 118,5 cm | Gross Weight (Packaged Weight): 40kg | Methacrylate cover included.

Im REFERENCES

- 45 MOBSC120SSNW
- 2.800 MOBSC120OFNW
- MOBSC120BXNW

GLOSSARY This technical catalogue is subject to periodic updates, the measurements or finishes may vary in future revisions.

White light (included)
 Warm light (included)
 RGB light (included)
 Warm light portable rechargeable battery (included)
 Led tube lighting (included)
 Led light flame effect
 Twilight sensor
 Motion sensor
 Electric charge (driver not included)
 Remote control (included)
 Dimmable
 Hanging product
 Floating, not submersible
 Integrated speakers
 Touch control
 Volumen of the plantation area
 IP Indicates the level of protection of the electrical or electronic equipment against the entry of external agents: dust or water
 Made of recyclable materials
 Artificial plants included

GLOSSARY This technical catalogue is subject to periodic updates, the measurements or finishes may vary in future revisions.

White light (included)
 Warm light (included)
 RGB light (included)
 Warm light portable rechargeable battery (included)
 Led tube lighting (included)
 Led light flame effect
 Twilight sensor
 Motion sensor
 Electric charge (driver not included)
 Remote control (included)
 Dimmable
 Hanging product
 Floating, not submersible
 Integrated speakers
 Touch control
 Volumen of the plantation area
 IP Indicates the level of protection of the electrical or electronic equipment against the entry of external agents: dust or water
 Made of recyclable materials
 Artificial plants included

WOODY

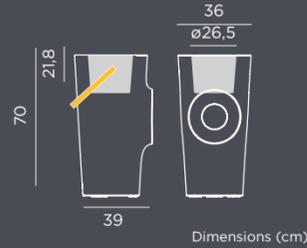

OPTIONS

- Solar & Rechargeable Battery | Indoor & outdoor use
- Rechargeable Battery | Play: Light & Music | Indoor & outdoor use

Packaging: 40,5 x 40,5 x 70 cm | Gross Weight (Packaged Weight): 5,2 kg | Vegan leather handle | Cooler accessory included. | Play Light & Music finished x1 Speaker.

Im	REFERENCES
45	LUMWD070SSNW
45	LUMWD070PLNW

AZALEA 50

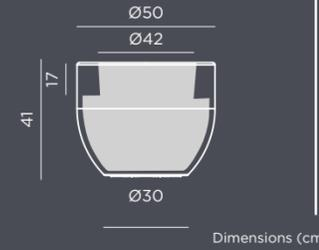

OPTIONS

- White Opaque Colour ●
- Black Opaque Colour ○
- Bronze Opaque Colour ○
- Terracota Opaque Colour ●
- Anthracite Opaque Colour ○

Packaging: Plastic bag | Gross Weight (Packaged Weight): 3,5kg | 37,8 L | Product with water reserve.

REFERENCES

JDNAZA050BXNLNW
JDNAZA050NXNLNW
JDNAZA050ZXNLNW
JDNAZA050TXNLNW
JDNAZA050ANLNW

FLOWERPOTS

In the section of pots you will find pots with double bottoms and pots without double bottoms.

Flowerpots with false bottom are recommended for the use of artificial plants.

Pots with double bottoms

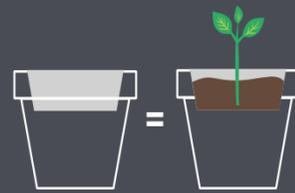

Pots without double bottoms



AZALEA 30

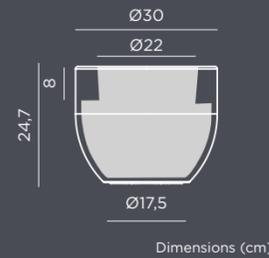

OPTIONS

- White Opaque Colour ●
- Black Opaque Colour ○
- Bronze Opaque Colour ○
- Terracota Opaque Colour ●
- Anthracite Opaque Colour ○

Packaging: Plastic bag | Gross Weight (Packaged Weight): 1kg | 9,4L | Product with water reserve.

REFERENCES

JDNAZA030BXNLNW
JDNAZA030NXNLNW
JDNAZA030ZXNLNW
JDNAZA030TXNLNW
JDNAZA030ANLNW

AZALEA 40

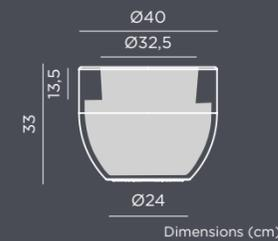

OPTIONS

- White Opaque Colour ●
- Black Opaque Colour ○
- Bronze Opaque Colour ○
- Terracota Opaque Colour ●
- Anthracite Opaque Colour ○

Packaging: Plastic bag | Gross Weight (Packaged Weight): 2kg | 19,7L | Product with water reserve.

REFERENCES

JDNAZA040BXNLNW
JDNAZA040NXNLNW
JDNAZA040ZXNLNW
JDNAZA040TXNLNW
JDNAZA040ANLNW

BAMBU 70

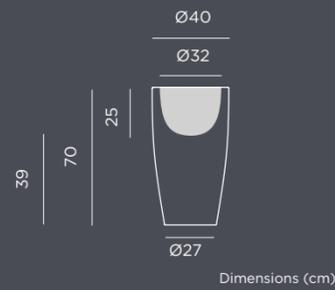

OPTIONS

WITH LIGHT

- Rechargeable Battery | Indoor & outdoor use
- Cable | Indoor & outdoor use

Packaging: 40 x 40 x 70 cm | Gross Weight (Packaged Weight): 4,5kg | 15,8 L | Finished double wall.

OPAQUE COLOUR (WITHOUT LIGHT)

- White Opaque Colour ●
- Black Opaque Colour ○
- Bronze Opaque Colour ○
- Terracota Opaque Colour ●
- Anthracite Opaque Colour ○

Packaging: 40 x 40 x 70 cm | Gross Weight (Packaged Weight): 4kg | 15,8 L | Finished double wall.

REFERENCES

315	LUMB070WLNW
600	LUMB070OFNW

BAMBU 90

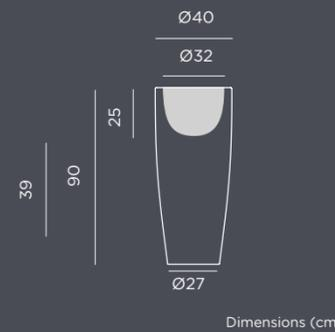

OPTIONS

WITH LIGHT

- Rechargeable Battery | Indoor & outdoor use
- Cable | Indoor & outdoor use

Packaging: 40,5 x 40,5 x 89,5 cm | Gross Weight (Packaged Weight): 6,5kg | 15,8 L | Finished double wall.

OPAQUE COLOUR (WITHOUT LIGHT)

- White Opaque Colour ●
- Black Opaque Colour ○
- Bronze Opaque Colour ○
- Terracota Opaque Colour ●
- Anthracite Opaque Colour ○

Packaging: 40,5 x 40,5 x 89,5 cm | Gross Weight (Packaged Weight): 6kg | 15,8 L | Finished double wall.

REFERENCES

335	LUMB090TWNW
900	LUMB090OFNW

CAMELIA 40

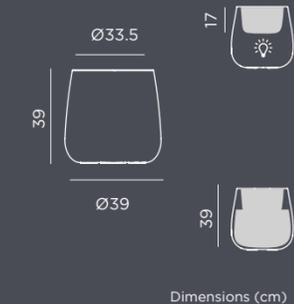

OPTIONS

WITH LIGHT

- Solar & Rechargeable Battery | Indoor & outdoor use
- Cable | Indoor & outdoor use

Packaging: 40,5 x 40,5 x 39,5 cm | Gross Weight (Packaged Weight): 3,2kg | 5,5 L | Finished double wall.

OPAQUE COLOUR (WITHOUT LIGHT)

- White Opaque Colour ●
- Black Opaque Colour ○
- Bronze Opaque Colour ○
- Anthracite Opaque Colour ○

Packaging: Plastic bag | Gross Weight (Packaged Weight): 2,2kg | 32,45 L | Finished double wall.

REFERENCES

45	LUMCA040SSNW
600	LUMCA040OFNW

GLOSSARY This technical catalogue is subject to periodic updates, the measurements or finishes may vary in future revisions.

White light (included) Warm light (included) RGB light (included) Warm light portable rechargeable battery (included) Led tube lighting (included) Led light flame effect Twilight sensor Motion sensor Electric charge (driver not included) Remote control (included) Dimmable Hanging product Floating, not submersible Integrated speakers Touch control Volumen of the plantation area IP Indicates the level of protection of the electrical or electronic equipment against the entry of external agents: dust or water Made of recyclable materials Artificial plants included

GLOSSARY This technical catalogue is subject to periodic updates, the measurements or finishes may vary in future revisions.

White light (included) Warm light (included) RGB light (included) Warm light portable rechargeable battery (included) Led tube lighting (included) Led light flame effect Twilight sensor Motion sensor Electric charge (driver not included) Remote control (included) Dimmable Hanging product Floating, not submersible Integrated speakers Touch control Volumen of the plantation area IP Indicates the level of protection of the electrical or electronic equipment against the entry of external agents: dust or water Made of recyclable materials Artificial plants included

CAMELIA 60

OPTIONS Im REFERENCES

WITH LIGHT

Solar & Rechargeable Battery | Indoor & outdoor use 45
 Cable | Indoor & outdoor use 600

RGB light (included) Warm light (included) RGB light (included) Warm light portable rechargeable battery (included) Led tube lighting (included) Led light flame effect Twilight sensor

Packaging: 60,5 x 60,5 x 42,7 cm | Gross Weight (Packaged Weight): 5kg | 29,4 L | Finished double wall.

OPAQUE COLOUR (WITHOUT LIGHT)

White Opaque Colour ● JDNCA060BXNW
 Black Opaque Colour ● JDNCA060NXNW
 Bronze Opaque Colour ● JDNCA060ZXNW
 Anthracite Opaque Colour ○ JDNCA060ANNW

Packaging: Plastic bag | Gross Weight (Packaged Weight): 4,5kg | 74 L | Finished double wall.

Dimensions (cm)

CAMELIA 80

OPTIONS Im REFERENCES

WITH LIGHT

Solar & Rechargeable Battery | Indoor & outdoor use 45
 Cable | Indoor & outdoor use 600

RGB light (included) Warm light (included) RGB light (included) Warm light portable rechargeable battery (included) Led tube lighting (included) Led light flame effect Twilight sensor

Packaging: Plastic bag | Gross Weight (Packaged Weight): 10,5kg | 74,8 L

OPAQUE COLOUR (WITHOUT LIGHT)

White Opaque Colour ● JDNCA080BXNW
 Black Opaque Colour ● JDNCA080NXNW
 Bronze Opaque Colour ● JDNCA080ZXNW
 Anthracite Opaque Colour ○ JDNCA080ANNW

Packaging: Plastic bag | Gross Weight (Packaged Weight): 10,5kg | 178,4 L | Finished double wall.

Dimensions (cm)

CAMELIA HIGH

OPTIONS Im REFERENCES

WITH LIGHT

Solar & Rechargeable Battery | Indoor & outdoor use 45
 Cable | Indoor & outdoor use 600

RGB light (included) Warm light (included) RGB light (included) Warm light portable rechargeable battery (included) Led tube lighting (included) Led light flame effect Twilight sensor

Packaging: 40,5 x 40,5 x 69,5 cm | Gross Weight (Packaged Weight): 4kg | 13,9 L | Finished double wall.

OPAQUE COLOUR (WITHOUT LIGHT)

White Opaque Colour ● JDNCAHIGBXNW
 Black Opaque Colour ● JDNCAHIGNXNW
 Bronze Opaque Colour ● JDNCAHIGZXNW
 Anthracite Opaque Colour ○ JDNCAHIGANNW

Packaging: Plastic bag | Gross Weight (Packaged Weight): 3,5kg | 53,7 L | Finished double wall.

Dimensions (cm)

CAMELIA LARGE

OPTIONS Im REFERENCES

WITH LIGHT

Solar & Rechargeable Battery | Indoor & outdoor use 45
 Cable | Indoor & outdoor use 250

RGB light (included) Warm light (included) RGB light (included) Warm light portable rechargeable battery (included) Led tube lighting (included) Led light flame effect Twilight sensor

Packaging: 50 x 50 x 111 cm | Gross Weight (Packaged Weight): 7,5kg | 43,4 L | Finished double wall.

OPAQUE COLOUR (WITHOUT LIGHT)

White Opaque Colour ● JDNCALARBXNW
 Black Opaque Colour ● JDNCALARXNW
 Bronze Opaque Colour ● JDNCALARZXNW
 Anthracite Opaque Colour ○ JDNCALARANNW

Packaging: Plastic bag | Gross Weight (Packaged Weight): 6kg | 101,58 L | Finished double wall.

Dimensions (cm)

GLOSSARY This technical catalogue is subject to periodic updates, the measurements or finishes may vary in future revisions.

White light (included) Warm light (included) RGB light (included) Warm light portable rechargeable battery (included) Led tube lighting (included) Led light flame effect Twilight sensor
 Motion sensor Electric charge (driver not included) Remote control (included) Dimmable Hanging product Floating, not submersible Integrated speakers Touch control Volumen of the plantation area IP Indicates the level of protection of the electrical or electronic equipment against the entry of external agents: dust or water Made of recyclable materials Artificial plants included

FICUS 60

OPTIONS Im REFERENCES

WITH LIGHT

Solar & Rechargeable Battery | Indoor & outdoor use 45
 Cable | Indoor & outdoor use 600

RGB light (included) Warm light (included) RGB light (included) Warm light portable rechargeable battery (included) Led tube lighting (included) Led light flame effect Twilight sensor

Packaging: 29,6 x 29,6 x 59,9 | Gross Weight (Packaged Weight): 2,6kg | 9 L

OPAQUE COLOUR (WITHOUT LIGHT)

White Opaque Colour ● JDNFC060BXNW
 Black Opaque Colour ● JDNFC060NXNW
 Bronze Opaque Colour ● JDNFC060ZXNW
 Anthracite Opaque Colour ○ JDNFC060ANNW

Packaging: Plastic bag | Gross Weight (Packaged Weight): 2,1kg | 16,1 L

Dimensions (cm)

FICUS 80

OPTIONS Im REFERENCES

WITH LIGHT

Solar & Rechargeable Battery | Indoor & outdoor use 45
 Cable | Indoor & outdoor use 600

RGB light (included) Warm light (included) RGB light (included) Warm light portable rechargeable battery (included) Led tube lighting (included) Led light flame effect Twilight sensor

Packaging: 29,5 x 29,5 x 59,9 | Gross Weight (Packaged Weight): 3,2kg | 9,5 L

OPAQUE COLOUR (WITHOUT LIGHT)

White Opaque Colour ● JDNFC080BXNW
 Black Opaque Colour ● JDNFC080NXNW
 Bronze Opaque Colour ● JDNFC080ZXNW
 Anthracite Opaque Colour ○ JDNFC080ANNW

Packaging: Plastic bag | Gross Weight (Packaged Weight): 2,7kg | 22,5 L

Dimensions (cm)

GERBERA 33

OPTIONS REFERENCES

White Opaque Colour ● JDNGB033BXNW
 Black Opaque Colour ● JDNGB033NXNW
 Bronze Opaque Colour ● JDNGB033ZXNW
 Topo Opaque Colour ● JDNGB033KXNW
 Terracota Opaque Colour ● JDNGB033TXNW
 Anthracite Opaque Colour ○ JDNGB033ANNW

Packaging: Plastic bag | Gross Weight (Packaged Weight): 1kg | 19,6L | Product with water reserve.

Dimensions (cm)

GERBERA 45

OPTIONS REFERENCES

White Opaque Colour ● JDNGB045BXNW
 Black Opaque Colour ● JDNGB045NXNW
 Bronze Opaque Colour ● JDNGB045ZXNW
 Topo Opaque Colour ● JDNGB045KXNW
 Terracota Opaque Colour ● JDNGB045TXNW
 Anthracite Opaque Colour ○ JDNGB045ANNW

Packaging: Plastic bag | Gross Weight (Packaged Weight): 2,2kg | 54,8L | Product with water reserve.

Dimensions (cm)

GLOSSARY This technical catalogue is subject to periodic updates, the measurements or finishes may vary in future revisions.

White light (included) Warm light (included) RGB light (included) Warm light portable rechargeable battery (included) Led tube lighting (included) Led light flame effect Twilight sensor
 Motion sensor Electric charge (driver not included) Remote control (included) Dimmable Hanging product Floating, not submersible Integrated speakers Touch control Volumen of the plantation area IP Indicates the level of protection of the electrical or electronic equipment against the entry of external agents: dust or water Made of recyclable materials Artificial plants included

GERBERA 50

OPTIONS



Dimensions (cm)

- White Opaque Colour ● _____ JDNGB050BXNW
- Black Opaque Colour ● _____ JDNGB050NXNW
- Bronze Opaque Colour ● _____ JDNGB050ZXNW
- Terracota Opaque Colour ● _____ JDNGB050TXNW
- Anthracite Opaque Colour ○ _____ JDNGB050ANNW

RUSTIC TEXTURE

Packaging: Plastic bag | Gross Weight (Packaged Weight): 4kg | 472,8L | Product with water reserve.

REFERENCES

HORTENSIA 40

OPTIONS

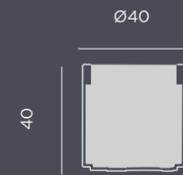

Dimensions (cm)

- White Opaque Colour ● _____ JDNHOR040BXNW
- Black Opaque Colour ● _____ JDNHOR040NXNW
- Bronze Opaque Colour ● _____ JDNHOR040ZXNW
- Topo Opaque Colour ● _____ JDNHOR040KXNW
- Terracota Opaque Colour ● _____ JDNHOR040TXNW
- Anthracite Opaque Colour ○ _____ JDNHOR040ANNW

Packaging: Plastic bag | Gross Weight (Packaged Weight): 2,5kg | 440L | Product with water reserve.

REFERENCES

LIFT SUPPORT ACCESSORIES

Accessories available only for Hortensia 30

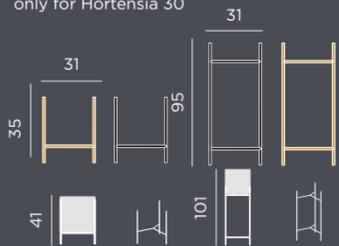

OPTIONS

- Support accessory 41cm black color ● _____ JDNLIFT30041NXNW
- Support accessory 41cm brass color ● _____ JDNLIFT30041BRNW
- Support accessory 101cm black color ● _____ JDNLIFT30110NXNW
- Support accessory 101cm brass color ● _____ JDNLIFT30110BRNW

Packaging (Support Accessory 41 cm): 29,2 x 36,9 x 2 cm | Gross Weight (Packaged Weight): 0,6kg

Packaging (Support Accessory 101 cm): 29,2 x 97 x 2 cm | Gross Weight (Packaged Weight): 1,6kg

REFERENCES

HORTENSIA 50

OPTIONS

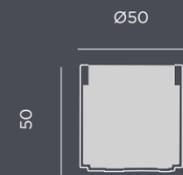

Dimensions (cm)

- White Opaque Colour ● _____ JDNHOR050BXNW
- Black Opaque Colour ● _____ JDNHOR050NXNW
- Bronze Opaque Colour ● _____ JDNHOR050ZXNW
- Topo Opaque Colour ● _____ JDNHOR050KXNW
- Terracota Opaque Colour ● _____ JDNHOR050TXNW
- Anthracite Opaque Colour ○ _____ JDNHOR050ANNW

Packaging: Plastic bag | Gross Weight (Packaged Weight): 4kg | 481,1L | Product with water reserve.

REFERENCES

HORTENSIA 30

OPTIONS

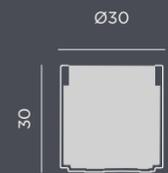

Dimensions (cm)

- White Opaque Colour ● _____ JDNHOR030BXNW
- Black Opaque Colour ● _____ JDNHOR030NXNW
- Bronze Opaque Colour ● _____ JDNHOR030ZXNW
- Topo Opaque Colour ● _____ JDNHOR030KXNW
- Terracota Opaque Colour ● _____ JDNHOR030TXNW
- Anthracite Opaque Colour ○ _____ JDNHOR030ANNW

Packaging: Plastic bag | Gross Weight (Packaged Weight): 1kg | 417,8L | Product with water reserve.

REFERENCES

HORTENSIA 80

OPTIONS

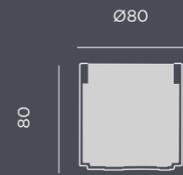

Big size

Dimensions (cm)

- White Opaque Colour ● _____ JDNHOR080BXNW
- Black Opaque Colour ● _____ JDNHOR080NXNW
- Bronze Opaque Colour ● _____ JDNHOR080ZXNW
- Terracota Opaque Colour ● _____ JDNHOR080TXNW
- Anthracite Opaque Colour ○ _____ JDNHOR080ANNW

Packaging: Plastic bag | Gross Weight (Packaged Weight): 12kg | 4343 L | Product with water reserve.

REFERENCES

HORTENSIA 40 HIGH

OPTIONS



Dimensions (cm)

- White Opaque Colour ● _____ JDNHOH040BXNXLNW
- Black Opaque Colour ● _____ JDNHOH040NXNXLNW
- Bronze Opaque Colour ● _____ JDNHOH040ZXNXLNW
- Terracota Opaque Colour ● _____ JDNHOH040TXNXLNW
- Anthracite Opaque Colour ○ _____ JDNHOH040ANNLNW
- Topo Opaque Colour ● _____ JDNHOH040KXNXLNW

Packaging: Plastic bag | Gross Weight (Packaged Weight): kg | 483,4 L | Product with water reserve.

REFERENCES

JARA 100X35

OPTIONS

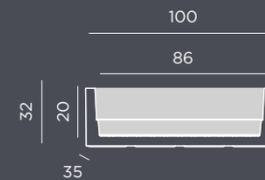

Dimensions (cm)

- White Opaque Colour ● _____ JDNJR100BXNW
- Black Opaque Colour ● _____ JDNJR100NXNW
- Bronze Opaque Colour ● _____ JDNJR100ZXNW
- Topo Opaque Colour ● _____ JDNJR100KXNW
- Terracota Opaque Colour ● _____ JDNJR100TXNW
- Anthracite Opaque Colour ○ _____ JDNJR100ANNW

Packaging: Plastic bag | Gross Weight (Packaged Weight): 7kg | 451,7L | Finished double wall. Product with water reserve.

REFERENCES

GLOSSARY This technical catalogue is subject to periodic updates, the measurements or finishes may vary in future revisions.

💡 White light (included) 🌞 Warm light (included) 🌈 RGB light (included) 🔋 Warm light portable rechargeable battery (included) 📡 Led tube lighting (included) 🔥 Led light flame effect 🌙 Twilight sensor 📡 Motion sensor 📡 Electric charge (driver not included) 📡 Remote control (included) 📡 Dimmable 📡 Hanging product 📡 Floating, not submersible 📡 Integrated speakers 📡 Touch control 📡 Volumen of the plantation area **IP** Indicates the level of protection of the electrical or electronic equipment against the entry of external agents: dust or water ♻️ Made of recyclable materials 🌿 Artificial plants included

GLOSSARY This technical catalogue is subject to periodic updates, the measurements or finishes may vary in future revisions.

💡 White light (included) 🌞 Warm light (included) 🌈 RGB light (included) 🔋 Warm light portable rechargeable battery (included) 📡 Led tube lighting (included) 🔥 Led light flame effect 🌙 Twilight sensor 📡 Motion sensor 📡 Electric charge (driver not included) 📡 Remote control (included) 📡 Dimmable 📡 Hanging product 📡 Floating, not submersible 📡 Integrated speakers 📡 Touch control 📡 Volumen of the plantation area **IP** Indicates the level of protection of the electrical or electronic equipment against the entry of external agents: dust or water ♻️ Made of recyclable materials 🌿 Artificial plants included

JARA 100X40

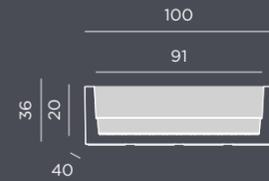

Dimensions (cm)

OPTIONS

White Opaque Colour ●	JDNJR140BXNW
Black Opaque Colour ●	JDNJR140NXNW
Bronze Opaque Colour ●	JDNJR140ZXNW
Topo Opaque Colour ●	JDNJR140KXNW
Terracota Opaque Colour ●	JDNJR140TXNW
Anthracite Opaque Colour ○	JDNJR140ANNW

Packaging: Plastic bag | Gross Weight (Packaged Weight): 8kg | 60,7L | Finished double wall. Product with water reserve.

REFERENCES

JUNCO 80



Dimensions (cm)

OPTIONS

WITH LIGHT

	Solar & Rechargeable Battery Indoor & outdoor use	45	LUMJN080SSNW
	Cable Indoor & outdoor use	600	LUMJN080OFNW

Packaging: 82 x 34 x 83 | Gross Weight (Packaged Weight): 12kg | 38,8 L | Finished double wall.

OPAQUE COLOUR (WITHOUT LIGHT)

White Opaque Colour ●	JDNJN080BXNW
Black Opaque Colour ●	JDNJN080NXNW
Bronze Opaque Colour ●	JDNJN080ZXNW
Topo Opaque Colour ●	JDNJN080KXNW
Anthracite Opaque Colour ○	JDNJN080ANNW

Packaging: Plastic bag | Gross Weight (Packaged Weight): 10kg | 38,8 L | Finished double wall.

REFERENCES

MAGNOLIA 60



Dimensions (cm)

OPTIONS

WITH LIGHT

	Solar & Rechargeable Battery Indoor & outdoor use	45	LUMMG060SSNW
	Cable Indoor & outdoor use	600	LUMMG060OFNW

Packaging: 59 x 59 x 59 cm | Gross Weight (Packaged Weight): 7kg | 36,7 L | Finished double wall.

OPAQUE COLOUR (WITHOUT LIGHT)

White Opaque Colour ●	JDNMG060BXNW
Black Opaque Colour ●	JDNMG060NXNW
Bronze Opaque Colour ●	JDNMG060ZXNW
Anthracite Opaque Colour ○	JDNMG060ANNW

Packaging: Plastic bag | Gross Weight (Packaged Weight): 5kg | 82,3 L | Product with water reserve.

REFERENCES

MAGNOLIA 30



Dimensions (cm)

OPTIONS

WITH LIGHT

	Solar & Rechargeable Battery Indoor & outdoor use	45	LUMMG030SSNW
--	---	----	--------------

Packaging: 32,5 x 32,5 x 33 cm | Gross Weight (Packaged Weight): 1,7kg | 3,7 L | Finished double wall.

OPAQUE COLOUR (WITHOUT LIGHT)

White Opaque Colour ●	JDNMG030BXNW
Black Opaque Colour ●	JDNMG030NXNW
Bronze Opaque Colour ●	JDNMG030ZXNW
Anthracite Opaque Colour ○	JDNMG030ANNW

Packaging: Plastic bag | Gross Weight (Packaged Weight): 0,9kg | 7,9 L

REFERENCES

MAGNOLIA 120



Dimensions (cm)

OPTIONS

WITH LIGHT

	Solar & Rechargeable Battery Indoor & outdoor use	600	JDNMGN120XXSSNW
	Cable Indoor & outdoor use	600	JDNMGN120XXOFNW

Packaging: Plastic bag | Gross Weight (Packaged Weight): 36kg | 282,2 L | Finished double wall.

OPAQUE COLOUR (WITHOUT LIGHT)

White Opaque Colour ●	JDNMGN120BXNLNW
Black Opaque Colour ●	JDNMGN120NXNLNW
Bronze Opaque Colour ●	JDNMGN120ZXNLNW
Anthracite Opaque Colour ○	JDNMGN120ANNLNW

Packaging: Plastic bag | Gross Weight (Packaged Weight): 35kg | 752,6 L

REFERENCES

MAGNOLIA 45



Dimensions (cm)

OPTIONS

WITH LIGHT

	Solar & Rechargeable Battery Indoor & outdoor use	45	LUMMG045SSNW
	Cable Indoor & outdoor use	600	LUMMG045OFNW

Packaging: 46 x 46 x 46,5 cm | Gross Weight (Packaged Weight): 4 kg | 19,4 L | Finished double wall.

OPAQUE COLOUR (WITHOUT LIGHT)

White Opaque Colour ●	JDNMG045BXNW
Black Opaque Colour ●	JDNMG045NXNW
Bronze Opaque Colour ●	JDNMG045ZXNW
Anthracite Opaque Colour ○	JDNMG045ANNW

Packaging: Plastic bag | Gross Weight (Packaged Weight): 2kg | 33,4 L

REFERENCES

MAGNOLIA 160

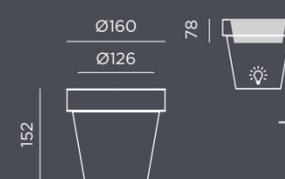

Dimensions (cm)

OPTIONS

WITH LIGHT

	Solar & Rechargeable Battery Indoor & outdoor use	600	JDNMGN160XXSSNW
	Cable Indoor & outdoor use	600	JDNMGN160XXOFNW

Packaging: Plastic bag | Gross Weight (Packaged Weight): 36kg | 282,2 L | Finished double wall.

OPAQUE COLOUR (WITHOUT LIGHT)

White Opaque Colour ●	JDNMGN160BXNLNW
Black Opaque Colour ●	JDNMGN160NXNLNW
Bronze Opaque Colour ●	JDNMGN160ZXNLNW
Anthracite Opaque Colour ○	JDNMGN160ANNLNW

Packaging: Plastic bag | Gross Weight (Packaged Weight): 35kg | 752,6 L

REFERENCES

GLOSSARY This technical catalogue is subject to periodic updates, the measurements or finishes may vary in future revisions.

White light (included) Warm light (included) RGB light (included) Warm light portable rechargeable battery (included) Led tube lighting (included) Led light flame effect Twilight sensor Motion sensor Electric charge (driver not included) Remote control (included) Dimmable Hanging product Floating, not submersible Integrated speakers Touch control Volumen of the plantation area **IP** Indicates the level of protection of the electrical or electronic equipment against the entry of external agents: dust or water Made of recyclable materials Artificial plants included

GLOSSARY This technical catalogue is subject to periodic updates, the measurements or finishes may vary in future revisions.

White light (included) Warm light (included) RGB light (included) Warm light portable rechargeable battery (included) Led tube lighting (included) Led light flame effect Twilight sensor Motion sensor Electric charge (driver not included) Remote control (included) Dimmable Hanging product Floating, not submersible Integrated speakers Touch control Volumen of the plantation area **IP** Indicates the level of protection of the electrical or electronic equipment against the entry of external agents: dust or water Made of recyclable materials Artificial plants included

MELISA 30

OPTIONS

Im REFERENCES

WITH LIGHT

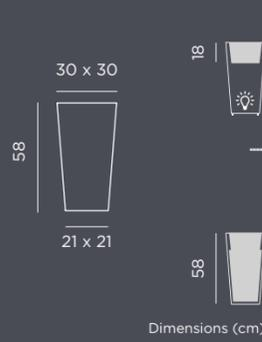

Solar & Rechargeable Battery | Indoor & outdoor use
Cable | Indoor & outdoor use

45 LUMML030SSNW
600 LUMML030OFNW

Packaging: 31 x 31 x 62,3 cm | Gross Weight (Packaged Weight): 4kg | 6,7 L | Finished double wall.

OPAQUE COLOUR (WITHOUT LIGHT)

White Opaque Colour ● JDNML030BXNW
Black Opaque Colour ● JDNML030NXNW
Bronze Opaque Colour ● JDNML030ZXNW
Topo Opaque Colour ● JDNML030KXNW

Terracota Opaque Colour ● JDNML030TXNW
Anthracite Opaque Colour ○ JDNML030ANNW

Dimensions (cm) | Packaging: Plastic bag | Gross Weight (Packaged Weight): 2,5kg | 11 L

MELISA 40

OPTIONS

Im REFERENCES

WITH LIGHT

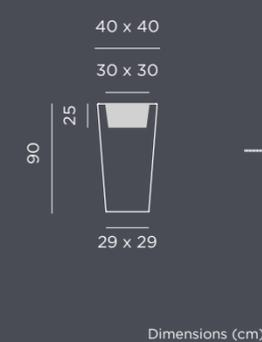

Solar & Rechargeable Battery | Indoor & outdoor use
Cable | Indoor & outdoor use

45 LUMML040SSNW
600 LUMML040OFNW

Packaging: 40,5 x 40,5 x 89,5 cm | Gross Weight (Packaged Weight): 7kg | 11,9 L | Finished double wall.

OPAQUE COLOUR (WITHOUT LIGHT)

White Opaque Colour ● JDNML040BXNW
Black Opaque Colour ● JDNML040NXNW
Bronze Opaque Colour ● JDNML040ZXNW
Anthracite Opaque Colour ○ JDNML040ANNW

Dimensions (cm) | Packaging: Plastic bag | Gross Weight (Packaged Weight): 6kg | 11,9 L | Finished double wall.

MELISA 50

OPTIONS

Im REFERENCES

WITH LIGHT

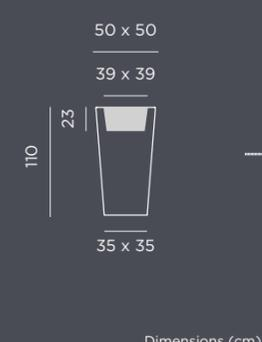

Solar & Rechargeable Battery | Indoor & outdoor use
Cable | Indoor & outdoor use

45 LUMML050SSNW
600 LUMML050OFNW

Packaging: 50 x 50 x 111 cm | Gross Weight (Packaged Weight): 11kg | 13,9 L | Finished double wall.

OPAQUE COLOUR (WITHOUT LIGHT)

White Opaque Colour ● JDNML050BXNW
Black Opaque Colour ● JDNML050NXNW
Bronze Opaque Colour ● JDNML050ZXNW
Anthracite Opaque Colour ○ JDNML050ANNW

Dimensions (cm) | Packaging: Plastic bag | Gross Weight (Packaged Weight): 10kg | 13,9 L | Finished double wall.

NARCISO 35

OPTIONS

REFERENCES

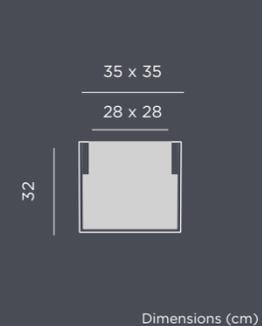

White Opaque Colour ● JDNNC035BXNW
Black Opaque Colour ● JDNNC035NXNW
Bronze Opaque Colour ● JDNNC035ZXNW
Terracota Opaque Colour ● JDNNC035TXNW
Anthracite Opaque Colour ○ JDNNC035ANNW

Dimensions (cm) | Packaging: Plastic bag | Gross Weight (Packaged Weight): 2kg | 17,4L

NARCISO 40

OPTIONS

Im REFERENCES

WITH LIGHT

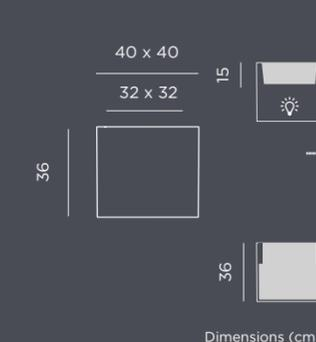

Solar & Rechargeable Battery | Indoor & outdoor use

45 LUMNCO40SSNW

Packaging: 40,5 x 40,5 x 38 cm | Gross Weight (Packaged Weight): 3,5kg | 8,6 L | Finished double wall.

OPAQUE COLOUR (WITHOUT LIGHT)

White Opaque Colour ● JDNNC040BXNW
Black Opaque Colour ● JDNNC040NXNW
Bronze Opaque Colour ● JDNNC040ZXNW

Terracota Opaque Colour ● JDNNC040TXNW
Anthracite Opaque Colour ○ JDNNC040ANNW

Dimensions (cm) | Packaging: Plastic bag | Gross Weight (Packaged Weight): 2,5kg | 27,8 L | Product with water reserve.

NARCISO 50

OPTIONS

Im REFERENCES

WITH LIGHT

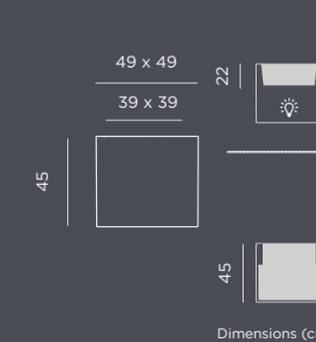

Solar & Rechargeable Battery | Indoor & outdoor use

45 LUMNCO50SSNW

Packaging: 59 x 59 x 59 cm | Gross Weight (Packaged Weight): 6,5kg | 19 L | Finished double wall.

OPAQUE COLOUR (WITHOUT LIGHT)

White Opaque Colour ● JDNNC050BXNW
Black Opaque Colour ● JDNNC050NXNW
Bronze Opaque Colour ● JDNNC050ZXNW

Terracota Opaque Colour ● JDNNC050TXNW
Anthracite Opaque Colour ○ JDNNC050ANNW

Dimensions (cm) | Packaging: Plastic bag | Gross Weight (Packaged Weight): 5kg | 53,8 L | Product with water reserve.

NARCISO 60

OPTIONS

REFERENCES

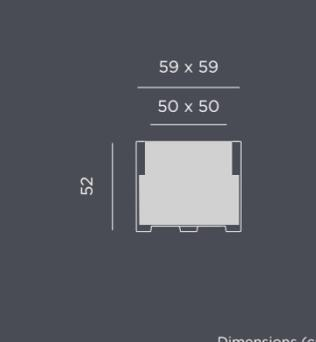

White Opaque Colour ● JDNNC060BXNW
Black Opaque Colour ● JDNNC060NXNW
Bronze Opaque Colour ● JDNNC060ZXNW
Anthracite Opaque Colour ○ JDNNC060ANNW

Dimensions (cm) | Packaging: Plastic bag | Gross Weight (Packaged Weight): 7kg | 84,8L

OLIVO 50

OPTIONS

REFERENCES

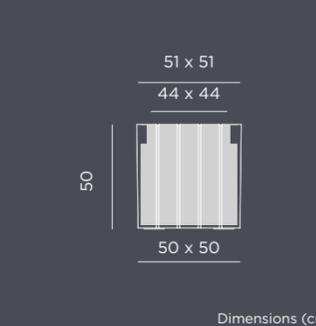

White Opaque Colour ● JDNOLI050BXNLNW
Black Opaque Colour ● JDNOLI050NXNLNW
Bronze Opaque Colour ● JDNOLI050ZXNLNW
Terracota Opaque Colour ● JDNOLI050TXNLNW
Anthracite Opaque Colour ○ JDNOLI050ANNLNW

Dimensions (cm) | Packaging: Plastic bag | Gross Weight (Packaged Weight): 4,5kg | 105L | Product with water reserve.

GLOSSARY This technical catalogue is subject to periodic updates, the measurements or finishes may vary in future revisions.

☀️ White light (included) ☀️ Warm light (included) 🌈 RGB light (included) 🔋 Warm light portable rechargeable battery (included) 📡 Led tube lighting (included) 🔥 Led light flame effect 🌙 Twilight sensor 📡 Motion sensor 🔌 Electric charge (driver not included) 📡 Remote control (included) 📊 Dimmable 📡 Hanging product 📡 Floating, not submersible 📡 Integrated speakers 📡 Touch control 📡 Volumen of the plantation area **IP** Indicates the level of protection of the electrical or electronic equipment against the entry of external agents: dust or water ♻️ Made of recyclable materials 🌿 Artificial plants included

GLOSSARY This technical catalogue is subject to periodic updates, the measurements or finishes may vary in future revisions.

☀️ White light (included) ☀️ Warm light (included) 🌈 RGB light (included) 🔋 Warm light portable rechargeable battery (included) 📡 Led tube lighting (included) 🔥 Led light flame effect 🌙 Twilight sensor 📡 Motion sensor 🔌 Electric charge (driver not included) 📡 Remote control (included) 📊 Dimmable 📡 Hanging product 📡 Floating, not submersible 📡 Integrated speakers 📡 Touch control 📡 Volumen of the plantation area **IP** Indicates the level of protection of the electrical or electronic equipment against the entry of external agents: dust or water ♻️ Made of recyclable materials 🌿 Artificial plants included

OLIVO HIGH

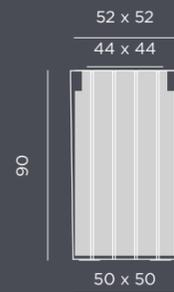

Dimensions (cm)

OPTIONS

- White Opaque Colour ● — JDNOLI090BXNLNW
- Black Opaque Colour ○ — JDNOLI090NXNLNW
- Bronze Opaque Colour ○ — JDNOLI090ZXNLNW
- Terracota Opaque Colour ● — JDNOLI090TXNLNW
- Anthracite Opaque Colour ○ — JDNOLI090ANLNLNW

Packaging: Plastic bag | Gross Weight (Packaged Weight): 8kg | 205L | Product with water reserve.

REFERENCES

OLIVO LARGE

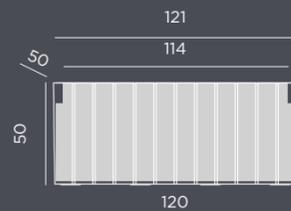

Dimensions (cm)

OPTIONS

- White Opaque Colour ● — JDNOLI120BXNLNW
- Black Opaque Colour ○ — JDNOLI120NXNLNW
- Bronze Opaque Colour ○ — JDNOLI120ZXNLNW
- Terracota Opaque Colour ● — JDNOLI120TXNLNW
- Anthracite Opaque Colour ○ — JDNOLI120ANLNLNW

Packaging: Plastic bag | Gross Weight (Packaged Weight): 7kg | 252L | Product with water reserve.

REFERENCES

PALMA 70



Dimensions (cm)

OPTIONS

WITH LIGHT

- ☀️ + 🔋 Solar & Rechargeable Battery | Indoor & outdoor use — 45 LUMPM070SSNW
- 🔌 Cable | Indoor & outdoor use — 600 LUMPM070OFNW

Packaging: 35,5 x 35,5 x 70 cm | Gross Weight (Packaged Weight): 4,5kg | 9,1 L | Finished double wall.

REFERENCES

VIOLETA 30

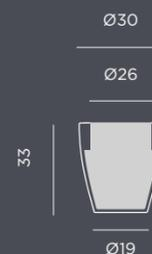

Dimensions (cm)

OPTIONS

- White Opaque Colour ● — JDNVL030BXNW
- Black Opaque Colour ○ — JDNVL030NXNW
- Bronze Opaque Colour ○ — JDNVL030ZXNW
- Topo Opaque Colour ○ — JDNVL030KXNW
- Terracota Opaque Colour ● — JDNVL030TXNW
- Anthracite Opaque Colour ○ — JDNVL030ANNW

Packaging: Plastic bag | Gross Weight (Packaged Weight): 1kg | 12,5L | Product with water reserve.

REFERENCES

VIOLETA 40

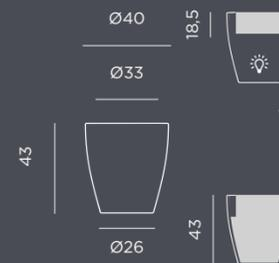

Dimensions (cm)

OPTIONS

WITH LIGHT

- ☀️ + 🔋 Solar & Rechargeable Battery | Indoor & outdoor use — 45 LUMVL040SSNW

Packaging: 46 x 46 x 46,5 cm | Gross Weight (Packaged Weight): 3kg | 14,5 L | Finished double wall.

OPAQUE COLOUR (WITHOUT LIGHT)

- White Opaque Colour ● — JDNVL040BXNW
- Black Opaque Colour ○ — JDNVL040NXNW
- Bronze Opaque Colour ○ — JDNVL040ZXNW
- Topo Opaque Colour ○ — JDNVL040KXNW
- Terracota Opaque Colour ● — JDNVL040TXNW
- Anthracite Opaque Colour ○ — JDNVL040ANNW

Packaging: Plastic bag | Gross Weight (Packaged Weight): 2,5kg | 30,6 L | Product with water reserve.

REFERENCES

VIOLETA 55



Dimensions (cm)

OPTIONS

WITH LIGHT

- ☀️ + 🔋 Solar & Rechargeable Battery | Indoor & outdoor use — 45 LUMVL055SSNW

Packaging: 59 x 59 x 59 cm | Gross Weight (Packaged Weight): 5,5kg | 34,7L | Finished double wall.

OPAQUE COLOUR (WITHOUT LIGHT)

- White Opaque Colour ● — JDNVL055BXNW
- Black Opaque Colour ○ — JDNVL055NXNW
- Bronze Opaque Colour ○ — JDNVL055ZXNW
- Terracota Opaque Colour ● — JDNVL055TXNW
- Anthracite Opaque Colour ○ — JDNVL055ANNW

Packaging: Plastic bag | Gross Weight (Packaged Weight): 5kg | 68,2 L | Product with water reserve.

REFERENCES

GLOSSARY This technical catalogue is subject to periodic updates, the measurements or finishes may vary in future revisions.

💡 White light (included) 🌞 Warm light (included) 🌈 RGB light (included) 🔋 Warm light portable rechargeable battery (included) 🏠 Led tube lighting (included) 🔥 Led light flame effect 🌙 Twilight sensor 🏠 Motion sensor 🔌 Electric charge (driver not included) 📶 Remote control (included) 📶 Dimmable 🏠 Hanging product 🏠 Floating, not submersible 🗣️ Integrated speakers 🖱️ Touch control 🌊 Volumen of the plantation area IP Indicates the level of protection of the electrical or electronic equipment against the entry of external agents: dust or water ♻️ Made of recyclable materials 🌿 Artificial plants included

GLOSSARY This technical catalogue is subject to periodic updates, the measurements or finishes may vary in future revisions.

💡 White light (included) 🌞 Warm light (included) 🌈 RGB light (included) 🔋 Warm light portable rechargeable battery (included) 🏠 Led tube lighting (included) 🔥 Led light flame effect 🌙 Twilight sensor 🏠 Motion sensor 🔌 Electric charge (driver not included) 📶 Remote control (included) 📶 Dimmable 🏠 Hanging product 🏠 Floating, not submersible 🗣️ Integrated speakers 🖱️ Touch control 🌊 Volumen of the plantation area IP Indicates the level of protection of the electrical or electronic equipment against the entry of external agents: dust or water ♻️ Made of recyclable materials 🌿 Artificial plants included



The possible differences between the original color, illumination and color captured are due to the printing technique.

NEWGARDEN reserves the right over photographs and designs made, so it is forbidden the manufacture, distribution and / or marketing of the products shown on any medium or support.

NEWGARDEN reserves the right to modify, in whole or in part, without prior notice, any information or technical specification of this publication.

All the information that appears in this catalog in terms of dimensions and capacity are approximate and are susceptible to variations due to improvements in the production process.

#BeHappy

@ Copyright. 2022. Newgarden Spain.

Todos los derechos reservados

**Avenida de Francia, 5-15 30840
Alhama de Murcia. Murcia (Spain)
info@newgarden.es
T. +34 968978806**

*new
garden*

be happy

