

STAKE FOLD

24-Jan.-2018

1.0

LED 8W | 220-240VAC | 50-60Hz | PCB 3-step | incl. PS | phase-cut dim

CE IP54 10.3m 0-90°

3000K | >80CRI | 480lm

dark grey texture

727274D4

OPTIONAL

groundspike

90013107

snoot

90019004

base plate

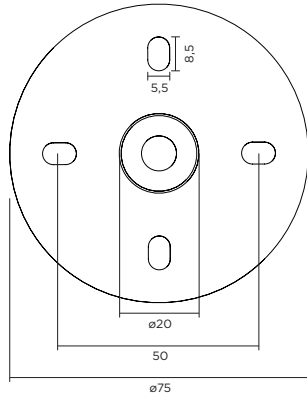

OPTIONAL, (ORDER SEPARATELY)
snoot dimensions

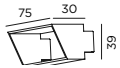

OPTIONAL, (ORDER SEPARATELY)
groundspike dimensions

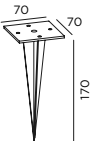

DIMENSIONS

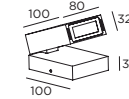

MOUNTING INSTRUCTION

- 1 Fix the base plate on the ground by using screws. In case of use with an optional groundspike or on a base*, remove the base plate with the side screws and fix directly on the previewed place on the groundspike.

POWER CONNECTION

- 2 Connect the wires with the waterproof connections

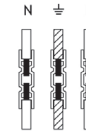

- 3 Attach the STAKE to the base plate with the side screws
- 4 OPTIONAL : mount the SNOOT on the STAKE and lock it with two allen screws.

3

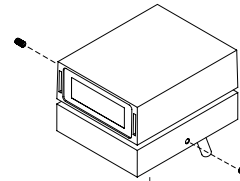

* DO NOT COVER BASE (moss, bark, ...).
Permanent moisture & possible chemical
processes from eg. fertilization might lead in
some combinations to a corrosive reaction.

1

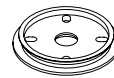

4 Mounting the SNOOT

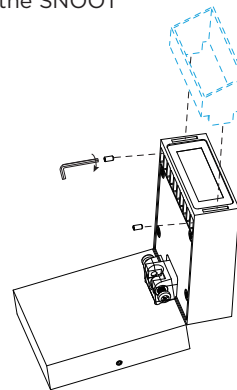

WEVER & DUCRÉ
LIGHTING

www.weverducre.com

Wever & Ducre bvba Kwadestraat 153 bus 2.1 8800 Roeselare

INSTALLATION
INSTRUCTIONS