

**9624210**

31,5W+ 8W LED / 35W Total  
 Incl. LED Board: L9002030 + L9002031  
 230V ~ 50Hz

**(DE) Bestimmungsgemäße Verwendung**

**(EN) Intended use | (FR) Utilisation conforme | (NL) Beoogd gebruik | (PL) Stosowanie zgodnie z przeznaczeniem | (NO) Riktig bruk | (DK) Korrekt brug  
 (SE) Avsedd användning | (FI) Määräystenmukainen käyttö | (IT) Impiego appropriato | (ES) Uso prescrito | (CZ) Použití v souladu s určením  
 (PT) Utilização correta | (GR) Ενδεδειγμένη χρήση | (SK) Predpokladané použitie | (EE) Eeldatav kasutus | (LV) Paredzamais lietojums  
 (LT) Numatomas naudojimas | (RO) Utilizare intenționată | (SI) Predvidena uporaba | (HR) Namjenska upotreba | (HU) Tervezett felhasználás  
 (BG) предназначена употреба | (AL) Përdorimi i parashikuar | (MK) Предвидена употреба | (TR) Amaçlı kullanım | (UK) Призначене використання  
 (BA,ME,RS) Namjenska upotreba**

<b>(DE)</b> Ortsfeste Verwendung als Deckenleuchte im Innenbereich	<b>(GB)</b> Provided for stationary indoor use on ceilings
<b>(FR)</b> Installation fixe en tant que plafonnier à l'intérieur	<b>(NL)</b> Vast gebruik als plafondlamp binnenshuis
<b>(PL)</b> Do montażu stacjonarnego jako lampa sufitowa do wnętrz	<b>(NO)</b> Til stasjonært bruk som taklampe innendørs
<b>(DK)</b> Til stationær brug som loftlampe indendørs	<b>(SE)</b> Används som fast taklampe inomhus
<b>(FI)</b> Kiinteä käyttö sisätilojen kattovalaisimena	<b>(IT)</b> Impiego fisso come plafoniera in ambienti interni
<b>(ES)</b> Empleo fijo como lámpara de techo en interiores	<b>(CZ)</b> Stacionární použití jako stropní svítidlo v interiéru
<b>(PT)</b> Aplicação fixa como luminária de teto em interiores	<b>(GR)</b> Σταθερή χρήση ως φωτιστικό οροφής σε εσωτερικό χώρο
<b>(SK)</b> Pevné použitie ako stropné svietidlo v interiéri	<b>(BG)</b> Постоянна употреба като таванно осветително тяло във вътрешни помещения
<b>(EE)</b> Laepaigaldatava sisevalgusti statsionaarne kasutamise	<b>(LV)</b> Pastāvīga izmantošana kā griestu gaismeklis iekštelpās
<b>(LT)</b> Stacionarus naudojimas kaip lubų šviestuvus viduje	<b>(RO)</b> Utilizare fixă ca plafonieră în interior
<b>(SI)</b> Stalna uporaba kot stropna svetilka v notranjosti	<b>(HR)</b> Stalna upotreba kao stropna svjetiljka u unutrašnjosti
<b>(HU)</b> Állandó használat mint mennyezetre szerelhető belső világítótest	<b>(AL)</b> I ofruar për përdorim të brendshëm të stacionar në tavan
<b>(MK)</b> Обезбедено за стационарна употреба на тавани внатре	<b>(TR)</b> Tavanlarda sabit iç mekan kullanımı için sağlanmıştır
<b>(UK)</b> Забезпечено для стаціонарного внутрішнього використання на стелях	<b>(BA)</b> Osigurano za stacionarnu unutarnju upotrebu na plafonima
	<b>(ME)</b>
	<b>(RS)</b>

(DE) Lieferumfang (EN) Package contents   (FR) Contenu de la livraison   (NL) Bij de levering inbegrepen   (PL) Zakres dostawy   (NO) Levering   (DK) Leveringsomfang (SE) Leveransomfattning   (FI) Toimitussisältö   (IT) Fornitura   (ES) Volumen de suministro   (CZ) Rozsah dodávky   (PT) Material fornecido (GR) Παραδοτέος εξοπλισμός   (SK) Obsah balenia   (EE) Pakendi sisu   (LV) Pakas saturs   (LT) Pakuotės turinys (RO) Conținutul pachetului   (SI) Vsebina paketa   (HR) Sadržaj paketa   (HU) A csomag tartalma   (BG) обхват на доставката (AL) Përmbajtja e dorëzimit   (MK) Содржина на испорака   (TR) Teslimat içeriği   (UK) Зміст доставки   (BA,ME,RS) Sadržaj isporuke		
(DE) 1 Deckenleuchte Montagematerial Montageanleitung	(GB) 1 Ceiling lamp Installation hardware Mounting instructions	(FR) 1 Plafonnier Matériel de montage Instructions de montage
(NL) 1 Plafondlamp Monteringsmateriale Montagehandleiding	(PL) 1 Lampa sufitowa Elementy montażowe Instrukcja montażu	(NO) 1 Taklampe Monteringsmateriale Brukerveiledning
(DK) 1 Loftlampe Monteringsmateriale Brugervejledning	(SE) 1 Taklampa Monteringsmaterial Monteringsanvisning	(FI) 1 Kattovalaisin Asennus materiaali Asennusohjeet
(IT) 1 Plafoniera Materiale di montaggio Istruzioni di montaggio	(ES) 1 Lámpara de techo Material de montaje Instrucciones de montaje	(CZ) 1 Stropní svítidlo Materiál pro montáž Návod k montáži
(PT) 1 Luminária de teto Material de montagem Instruções de montagem	(GR) 1 Φωτιστικό οροφής Υλικό συναρμολόγησης Οδηγίες συναρμολόγησης	(SK) 1 stropné svietidlo Inštalčný hardvér Inštalčná príručka
(BG) 1 таванно осветително тяло материали за монтаж инструкции за монтаж	(EE) 1 laevalgusti Paigaldustarvikud Paigaldusjuhend	(LV) 1 griestu gaismeklis Instalācijas aparatūra Uzstādīšanas instrukcija
(LT) 1 lubų šviestuvai Montavimo aparatinė įranga Montavimo instrukcija	(RO) 1 plafonieră Hardware de instalare Instrucțiuni de montare	(SI) 1 stropna svetilka Namestitvena strojna oprema Navodila za montažo
(HR) 1 stropna svjetiljka Instalacijski hardver Upute za montažu	(HU) 1 mennyezeti világítótest Telepítési hardver Szerelési útmutató	(AL) 1 Lampa tavan Materiali i montimit Udhëzuesi i montimit
(MK) 1 Плафонска лампа Монтажен материјал Упатство за монтажа	(TR) 1 Tavan lambası Montaj malzemesi Montaj kılavuzu	(UK) 1 Світильник на стелі Монтажний матеріал Інструкція з монтажу
(BA) 1 Plafonska lampa (ME) Montažni materijal (RS) Uputstvo za montažu		

# ARCCHIO

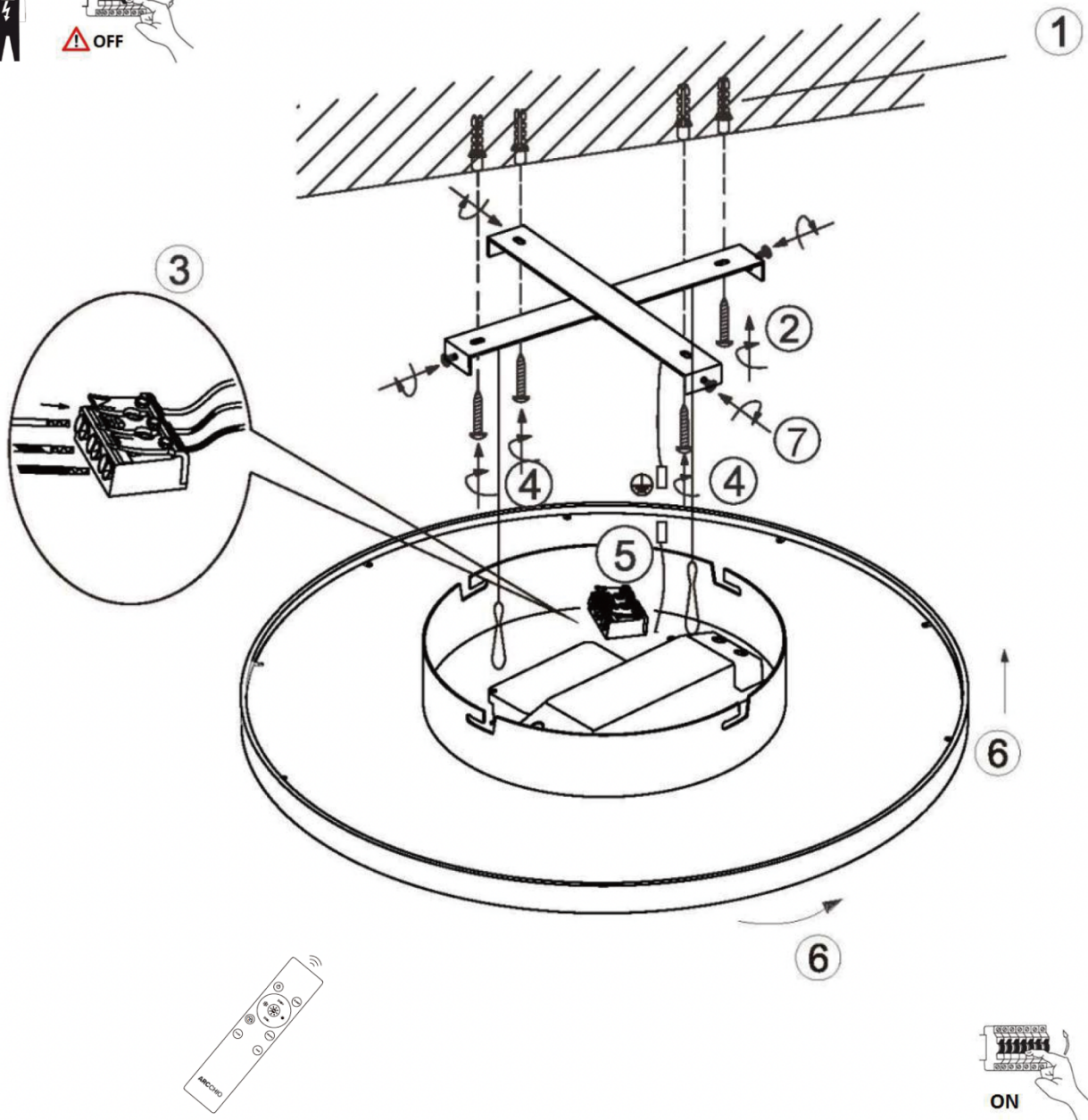
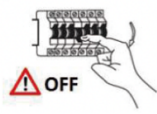

	(DE)	(EN)	(FR)	(NL)	(PL)	(NO)
<b>L</b>	Stromführender Leiter	Live conductor	Conducteur	Spanningvoerende draad	Przewód prądowy	Strømførende leder
	Schutzleiter	Earth conductor	Conducteur de protection (terre)	Aardkabel	Przewód uziemiający	Jordledningen
<b>N</b>	Neutralleiter	Neutral conductor	Conducteur neutre	Nulleider	Przewód zerowy	Nøytralleider

	(DK)	(SE)	(FI)	(IT)	(ES)	(CZ)
<b>L</b>	Strømførende leder	Strömförande ledare	Virtajohdin	Conduttore sotto tensione	Conductor de corriente	Vodič pod napětím
	Jordledningen	Skyddsledare	Suojajohdin	Conduttore di terra	Conductor de protección	Ochranný vodič
<b>N</b>	Neutralleider	Neutralledare	Nollajohdin	Conduttore neutro	Conductor neutro	Neutrální vodič

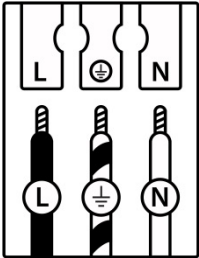

	(PT)	(GR)	(SK)	(EE)	(LV)	(LT)
<b>L</b>	Condutor vivo	Ρευματοφόρος αγωγός	Živý vodič	Faasisjuht	Dzīvais vadītājs	Gyvas dirigentas
	Condutor de terra	Αγωγός γείωσης	Zemný vodič	Maandusjuht	Zemes vadītājs	Žemės dirigentas
<b>N</b>	Condutor neutro	Ουδέτερος αγωγός	Neutrálný vodič	Neutraaljuht	Neitrālais vadītājs	Neutrinis dirigentas

	(RO)	(SI)	(HR)	(HU)	(BG)	(AL)
<b>L</b>	Conductor viu	Živi dirigent	Živi dirigent	Élő vezető	проводник под напряжение	Konduktor i gjallë
	Conductor de împământare	Zemeljski dirigent	Uzemljeni dirigent	Földvezető	защитен проводник	Dirigjent i tokës
<b>N</b>	Conductor neutru	Nevtralni dirigent	Neutralni dirigent	Semleges vezető	нулев проводник	Konduktor neutral

	(MK)	(TR)	(UK)	(BA)(ME)(RS)
<b>L</b>	Жив кондуктор	Canlı yönetici	Живий диригент	Živi dirigent
	Земјен проводник	Toprak iletkeni	Земельний провідник	Zemaljski provodnik
<b>N</b>	Неутрален проводник	Nötr iletken	Нейтральный провідник	Neutralni provodnik

## (DE) Verwendete Symbole





(EN) Safety Precautions | (FR) Symboles utilisés | (NL) Gebruikte symbolen | (PL) Stosowane symbole | (NO) Brukte symboler | (DK) Brugte symboler  
 (SE) Använda symboler | (FI) Käytetyt symbolit | (IT) Simboli usati | (ES) Símbolos empleados | (CZ) Použité symboly | (PT) Símbolos utilizados  
 (GR) Χρησιμοποιούμενα σύμβολα | (SK) Bezpečnostné opatrenia | (EE) Ohutusabinõud | (LV) Drošības pasākumi  
 (LT) Saugos priemonės | (RO) Măsuri de precauție | (SI) Varnostni ukrepi | (HR) Mjere opreza | (HU) Használt szimbólumok | (BG) Мерки за безопасност  
 (AL) Simbolet e përdorura | (MK) Користени симболи | (TR) Kullanılan semboller | (UK) Використовувані символи | (BA,ME,RS) Korišteni simboli

IP 20





# ARCCHIO

## Funktionsweise der Fernbedienung / operation with the remote control / Fonction de la télécommande

	(D)	(GB)	(F)
	AN/ AUS	ON/ OFF	MARCHE/ ARRÊT
	Dimmen (10%-100%) Beleuchtungsmodus (3000K-6000K)	Dimmable (10%-100%) Lighting mode (3000K- 6000K)	Gradation (10% -100%) Mode d'éclairage (3000K-6000K)
	100% Helligkeit	Switch on LED to 100%	Luminosité à 100%
	Schlafmodus: Licht dimmt auf 10% & 3000K	Sleep Mode: switch on LED at 10% & 3000K	Mode veille : La lumière diminue à 10% et 3000K
	CCT/ W / CCT&W	CCT/ W / CCT&W	CCT/ Blanc / CCT&Blanc

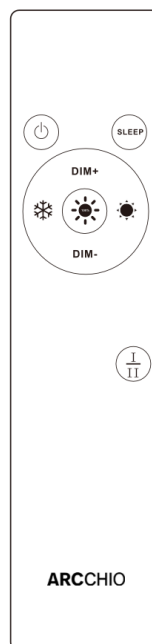
 <5m



	QR	EAN
<p>(DE) Dieses Produkt enthält eine Lichtquelle der Energieeffizienzklasse F            (EN) This product contains a light source of energy efficiency class F            (FR) Ce produit comprend une source de lumière de classe d'efficacité énergétique F            (NL) Dit product bevat een lichtbron van energie-efficiëntieklasse F            (PL) Produkt ten zawiera źródło światła o klasie efektywności energetycznej F            (NO) Dette produktet inneholder en lyskilde i energieeffektivitetsklasse F            (DK) Dette produkt indeholder en lyskilde af energieeffektklasse F            (SE) Denna produkt innehåller en ljuskälla i energieffektivitetsklass F            (FI) Tämä tuote sisältää energiatehokkuusluokan F valonlähteen            (IT) Questo prodotto contiene una sorgente luminosa della classe di efficienza energetica F            (ES) Este producto contiene una fuente de luz de la clase de eficiencia energética F            (CZ) Tento výrobek obsahuje světelný zdroj třídy energetické účinnosti F            (PT) Este produto contém uma fonte de luz da classe de eficiência energética F            (GR) Αυτό το προϊόν περιέχει μια φωτεινή πηγή ενεργειακής απόδοσης κλάσης F            (SK) Tento výrobok obsahuje zdroj svetla triedy energetickej efektivity F            (EE) See toode sisaldab energiatõhususklassi F valgusallikat            (LV) Šis produkts satur enerģijas efektivitātes klases F gaismas avotu            (LT) Šis gaminys turi energijos efektyvumo klasės F šviesos šaltinį            (RO) Acest produs conține o sursă de lumină de clasă de eficiență energetică F            (SI) Ta izdelek vsebuje svetlobni vir energijskega razreda F            (HR) Ovaj proizvod sadrži izvor svjetlosti energetske učinkovitosti klase F            (HU) Ez a termék egy F energiahatékonysági osztályú fényforrást tartalmaz            (BG) Този продукт съдържа източник на светлина с клас на енергийна ефективност: F            (AL) Ky produkt përmban një burim drite të klasës së efikasitetit të energjisë F            (MK) Овој производ содржи извор на светлина од класа на енергетска ефикасност F            (TR) Bu ürün, enerji verimliliği sınıfı F olan bir ışık kaynağı içerir            (UK) Цей продукт містить джерело світла класу енергоефективності F            (BA)(ME)(RS) Ovaj proizvod sadrži izvor svjetlosti energetske klase F</p>		<p>4251911738957</p>

	QR	EAN
<p>(DE) Dieses Produkt enthält eine Lichtquelle der Energieeffizienzklasse F            (EN) This product contains a light source of energy efficiency class F            (FR) Ce produit comprend une source de lumière de classe d'efficacité énergétique F            (NL) Dit product bevat een lichtbron van energie-efficiëntieklasse F            (PL) Produkt ten zawiera źródło światła o klasie efektywności energetycznej F            (NO) Dette produktet inneholder en lyskilde i energieeffektivitetsklasse F            (DK) Dette produkt indeholder en lyskilde af energieeffektklasse F            (SE) Denna produkt innehåller en ljuskälla i energieffektivitetsklass F            (FI) Tämä tuote sisältää energiatehokkuusluokan F valonlähteen            (IT) Questo prodotto contiene una sorgente luminosa della classe di efficienza energetica F            (ES) Este producto contiene una fuente de luz de la clase de eficiencia energética F            (CZ) Tento výrobek obsahuje světelný zdroj třídy energetické účinnosti F            (PT) Este produto contém uma fonte de luz da classe de eficiência energética F            (GR) Αυτό το προϊόν περιέχει μια φωτεινή πηγή ενεργειακής απόδοσης κλάσης F            (SK) Tento výrobok obsahuje zdroj svetla triedy energetickej efektivity F            (EE) See toode sisaldab energiatõhususklassi F valgusallikat            (LV) Šis produkts satur enerģijas efektivitātes klases F gaismas avotu            (LT) Šis gaminys turi energijos efektyvumo klasės F šviesos šaltinį            (RO) Acest produs conține o sursă de lumină de clasă de eficiență energetică F            (SI) Ta izdelek vsebuje svetlobni vir energijskega razreda F            (HR) Ovaj proizvod sadrži izvor svjetlosti energetske učinkovitosti klase F            (HU) Ez a termék egy F energiahatékonysági osztályú fényforrást tartalmaz            (BG) Този продукт съдържа източник на светлина с клас на енергийна ефективност: F            (AL) Ky produkt përmban një burim drite të klasës së efikasitetit të energjisë F            (MK) Овој производ содржи извор на светлина од класа на енергетска ефикасност F            (TR) Bu ürün, enerji verimliliği sınıfı F olan bir ışık kaynağı içerir            (UK) Цей продукт містить джерело світла класу енергоефективності F            (BA)(ME)(RS) Ovaj proizvod sadrži izvor svjetlosti energetske klase F</p>		<p>4251911738964</p>

	<p>(DE) Durch einen Fachmann austauschbare Lichtquelle (nur LED).          (EN) Replaceable (LED only) light source by a professional.          (FR) Source de lumière remplaçable (LED uniquement) par un professionnel.          (NL) Lichtbron (alleen led) te vervangen door een professional.          (PL) Wymienne (tylko LED) źródło światła wykonane przez profesjonalistę.          (NO) Utskiftbar (kun LED) lyskilde av en profesjonell.          (DK) Udskiftelig lyskilde (kun LED), udskiftes af en elektriker.          (SE) Ljuskälla (endast LED) utbytbar genom fackman.          (FI) Ammattilainen voi vaihtaa vaihdettavan (vain LED) valonlähteen.          (IT) Sorgente luminosa (solo LED) sostituibile da un professionista.          (ES) Fuente de luz (solo LED) sustituible por un profesional.          (CZ) Vyměnitelný (pouze LED) světelný zdroj odborníkem.          (PT) Luz LED (apenas LED) substituível por um profissional.          (GR) Η πηγή φωτός (μόνο LED) να αντικαθίσταται από επαγγελματία.          (SK) Zdroj svetla (iba LED) vymeniteľný prostredníctvom odborníka.          (EE) Spetsialisti poolt vahetata valgusallikas (ainult LED).          (LV) Speciālista maināms gaismas avots (tikai LED).          (LT) Specialisto keičiamas šviesos šaltinis (tik LED).          (RO) Sursă de lumină schimbabilă de către un specialist (doar LED).          (SI) Svetlobni vir, ki ga lahko zamenja strokovnjak (samo LED).          (HR) Izvor svjetlosti koji može zamijeniti stručnjak (samo LED).          (HU) Szakember által cserélhető (csak LED) fényforrás.          (BG) Светлинен източник, който може да се смени от специалист (само LED).          (AL) Burim drite i zëvendësueshëm (LED vetëm) nga një profesionist.          (MK) Изворот на светлина (само LED) се заменува од професионалец.          (TR) Değiştirilebilir (yalnızca LED) ışık kaynağı bir profesyonel tarafından değiştirilir.          (UK) Замінний (тільки LED) джерело світла замінюється фахівцем.          (BA)(ME)(RS) Zamjenjiv (samo LED) izvor svjetlosti zamjenjuje profesionalac.</p>
--	---

	<p>(DE) Durch einen Fachmann austauschbares Betriebsgerät.          (EN) Replaceable control gear by a professional.          (FR) Contrôleur remplaçable par un professionnel.          (NL) Voorschakelapparatuur te vervangen door een professional.          (PL) Wymienny układ sterujący przez profesjonalistę.          (NO) Utskiftbar kontrollutstyr av en profesjonell.          (DK) Udskiftelig igangsætter, udskiftes af en elektriker.          (SE) Styrdon utbytbar genom fackman.          (FI) Ammattilainen voi vaihtaa vaihdettavat ohjauslaitteet.          (IT) Dispositivo di controllo sostituibile da un professionista.          (ES) Dispositivo de control sustituible por un profesional.          (CZ) Vyměnitelný předřadník odborníkem.          (PT) Dispositivo de controlo substituível por um profissional.          (GR) Ο εξοπλισμός ελέγχου να αντικαθίσταται από επαγγελματία.          (SK) Predradník vymeniteľný prostredníctvom odborníka.          (EE) Spetsialisti poolt vahetata juhtseade.          (LV) Speciālista maināma vadības iekārta.          (LT) Specialisto keičiamas valdymo įrenginys.          (RO) Aparat de comandă schimbabil de către un specialist.          (SI) Nadomestna krmilna naprava, ki jo lahko zamenja strokovnjak.          (HR) Zamjenjivi upravljački sklop koji može zamijeniti stručnjak.          (HU) Szakember által cserélhető vezérlőszerkezet.          (BG) Уред, който може да се смени от специалист.          (AL) Pajisje kontrolli e zëvendësueshme nga një profesionist.          (MK) Заменлива контролна опрема од страна на професионалец.          (TR) Profesyonel tarafından değiştirilebilir kontrol donanımı.          (UK) Замінний контрольний пристрій фахівцем.          (BA)(ME)(RS) Zamjenjiva kontrolna oprema od strane profesionalca.</p>
--	--