

OMLED One f2, f3, f5, f3l

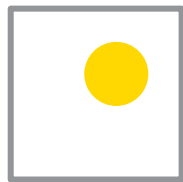

OMLED

DEUTSCH

Garantie:

Sie haben ein hochwertiges Produkt erworben, welches mit Sorgfalt produziert und verpackt worden ist. Sollten Sie dennoch einmal Grund zur Beanstandung haben, wenden Sie sich bitte an den Kundenservice von OMLED. Ihre Reklamation wird dort umgehend bearbeitet.

Bitte haben Sie Verständnis, dass eine Garantie unsererseits nur bei sachgemäßer Montage übernommen werden.

Bitte bewahren Sie die Versandverpackung sorgfältig auf.

OMLED One f2, f3, f5, f3l

Reinigung:

Bitte die Leuchte ausschließlich mit einem trockenen Tuch reinigen. Bei hartnäckigen Verunreinigungen bitte ausschließlich handelsübliche Glasreiniger verwenden. Wir empfehlen Microfasertücher für empfindliche Oberflächen. Bitte vor der Reinigung der Leuchte den Netzstecker ziehen.



OMLED One f2

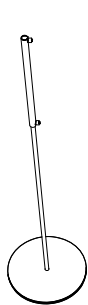

OMLED One f3

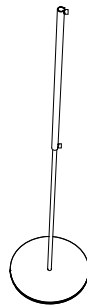

OMLED One f5

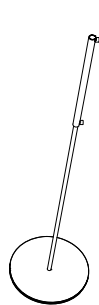

OMLED One f3l



Lösen der Befestigungsmutter.

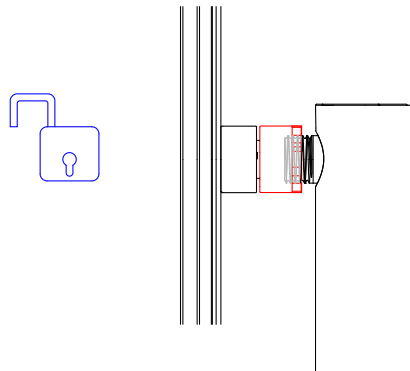
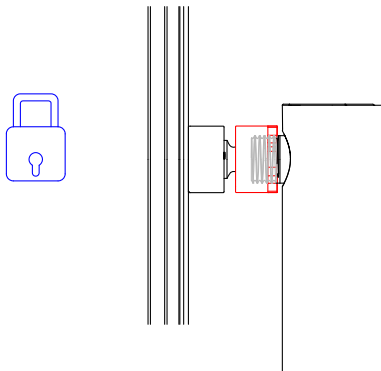

Befestigung des Glaspanels
am Stativ. Kontaktstifte rasten
hörbar ein.

Um eine falsche Kontaktierung
auszuschließen, bitte beachten,
dass das OMLED-Logo sich am
unteren Kontaktstift befindet.

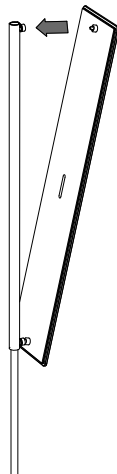
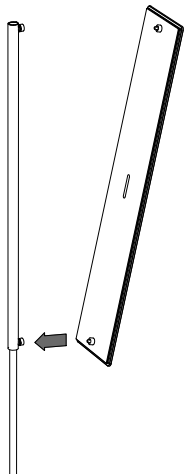

Festziehen der Feststellmutter mithilfe des beiliegenden OMLED-Montageschlüssels.

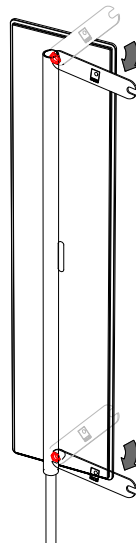

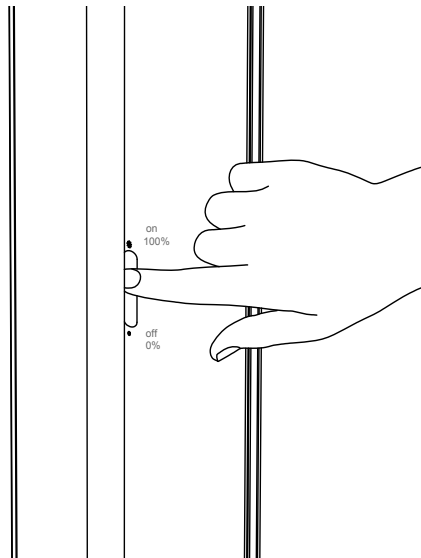

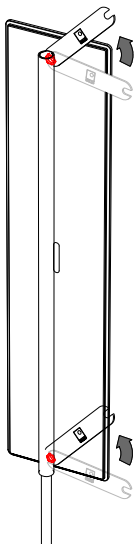

Lösen der Feststellmutter mithilfe des beiliegenden OMLED-Montageschlüssels bis sich der Kontaktstift frei in der Kontaktzange bewegen lässt.

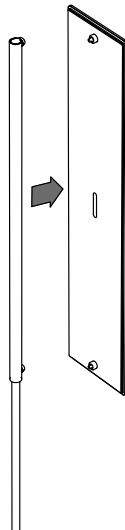
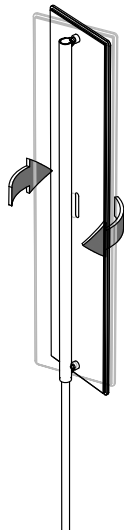
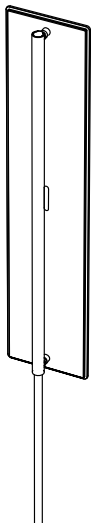

Durch vorsichtiges Verdrehen des Glaspanels lösen sich die Kontaktzangen und das Glaspanel kann vom Stativ entnommen werden.

ENGLISH

Warranty:

You have acquired a high-quality product, which has been manufactured and packaged with care. Should you nevertheless have grounds for complaint, please contact the customer service of OMLED. They will deal with your complaint immediately.

This warranty applies only to products that have been fitted appropriately.

Please store the package in a safe place for later use.

OMLED One f2, f3, f5, f3l

Cleaning:

Please clean the lamp with a dry cloth. We recommend microfibre cloths for sensitive surfaces.

Please remove the power plug before cleaning the lamp.



OMLED One f2



OMLED One f3

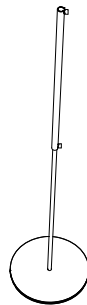

OMLED One f5

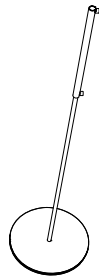

OMLED One f3l



Loosening of the mounting nut.

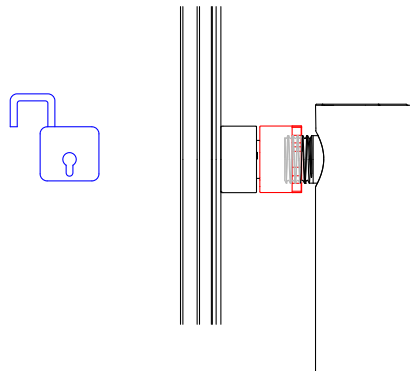
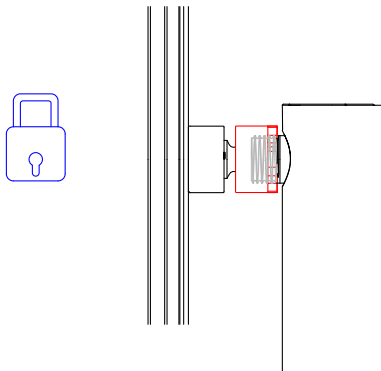

Fixation of the glass panel onto the tripod. Contact pin clicks hearable into place.

To avoid false contacting please be aware that for the fixation the OMLED-Logo needs to be next to the bottom contact pin.

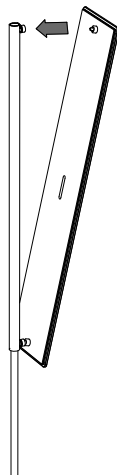
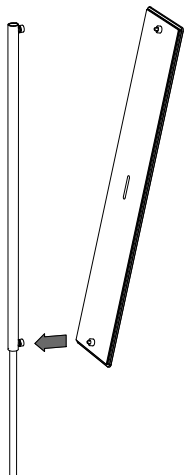

Tighten the fixing nut with the aid of the enclosed OMLED installation wrench.

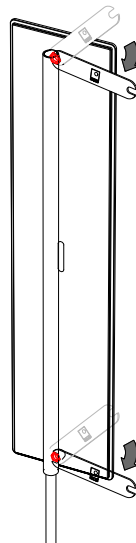

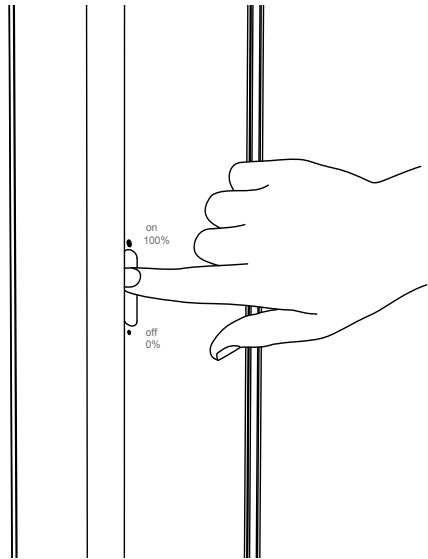

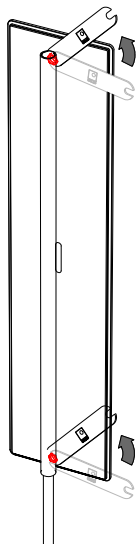

Loosen the fixing nuts with the aid of the enclosed OMLED installation wrench until the contact pin is freely moveable inside of the contact plier.

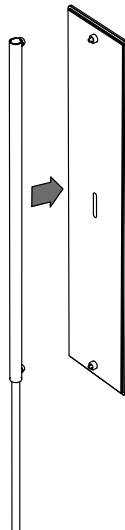
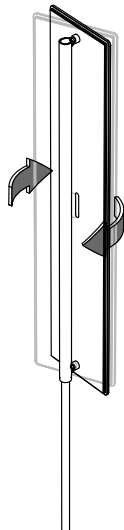
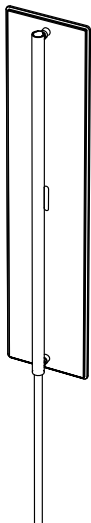

Through careful twisting of the glass panel the contact pliers can be loosened and the glass panel can be removed.



OMLED ist eine Marke
der EMDE development
of light GmbH
Friedberger Landstr. 645
60389 Frankfurt am Main

t + 49 69 47 88 15 - 0
f + 49 69 47 88 15 - 77

info@omled.com
www.omled.com