

9621652

21W LED / 27,5W Total@3000K

Incl. LED Board: L9002208

230V ~ 50Hz

**(DE) Bestimmungsgemäße Verwendung**

(GB) Intended use / (FR) Utilisation conforme / (NL) Beoogd gebruik / (PL) Stosowanie zgodnie z przeznaczeniem / (NO) Riktig bruk / (DK) Korrekt brug / (SE) Avsedd användning / (FI) Määräystenmukainen käyttö

(IT) Impiego appropriato / (ES) Uso prescrito / (CZ) Použití v souladu s určením / (PT) Utilização correta / (GR) Ενδεδειγμένη χρήση

(DE)	Ortsfeste Verwendung als Deckenleuchte im Innenbereich	(GB)	Provided for stationary indoor use on ceilings
(FR)	Installation fixe en tant qu'plafonnier, à l'intérieur	(NL)	Vast gebruik als plafondlamp binnenshuis
(PL)	Do montażu stacjonarnego jako lampa sufitowa do wnętrza	(NO)	Til stasjonært bruk som taklampe innendørs
(DK)	Til stationær brug som loftlampe indendørs	(SE)	Används som fast taklampe inomhus
(FI)	Kiinteä käyttö sisätilojen kattovalaisimena	(IT)	Impiego fisso come plafoniera in ambienti interni
(ES)	Empleo fijo en tanto lámpara de techo en interiores	(CZ)	Stacionární použití jako stropní svítidlo v interiéru
(PT)	Aplicação fixa como luminária de teto em interiores	(GR)	Σταθερή χρήση ως φωτιστικό οροφής σε εσωτερικό χώρο

(DE) Verwendete Symbole

(GB) Safety Precautions / (FR) Symboles utilisés / (NL) Gebruikte symbolen / (PL) Stosowane symbole / (NO) Brukte symboler / (DK) Brugte symboler / (SE) Använda symboler / (FI) Käytetyt symbolit / (IT) Simboli usati / (ES) Símbolos empleados / (CZ) Použité symboly / (PT) Símbolos utilizados / (GR) Χρησιμοποιούμενα σύμβολα

IP 20

**(DE) Lieferumfang**

(GB) Package contents / (FR) Contenu de la livraison / (NL) Bij de levering inbegrepen / (PL) Zakres dostawy / (NO) Leveringsomfang / (DK) Leveringsomfang / (SE) Leveransomfattning / (FI) Toimitussisältö / (IT) Fornitura / (ES) Volumen de suministro / (CZ) Rozsah dodávky / (PT) Material fornecido / (GR) Παραδοτέος εξοπλισμός

(DE)	1 Deckenleuchte Montagematerial Montageanleitung	(GB)	1 Ceiling lamp Installation hardware Mounting instructions	(FR)	1 Plafonnier Matériel de montage Instructions de montage
(NL)	1 Plafondlamp Monteringsmateriale Montagehandleiding	(PL)	1 Lampa sufitowa Elementy montażowe Instrukcja montażu	(NO)	1 Taklampe Monteringsmateriale Brukerveiledning
(DK)	1 Loftlampe Monteringsmateriale Brugervejledning	(SE)	1 Taklampe Monteringsmaterial Monteringsanvisning	(FI)	1 Kattovalaisin Asennus materiaali Asennusohjeet
(IT)	1 Plafoniera Materiale di montaggio Istruzioni di montaggio	(ES)	1 Lámpara de techo Material de montaje Instrucciones de montaje	(CZ)	1 Stropní svítidlo Materiál pro montáž Návod k montáži
(PT)	1 Luminária de teto Material de montagem Instruções de montagem	(GR)	1 Φωτιστικό οροφής Υλικό συναρμολόγησης Οδηγίες συναρμολόγησης		

ARCCHIO

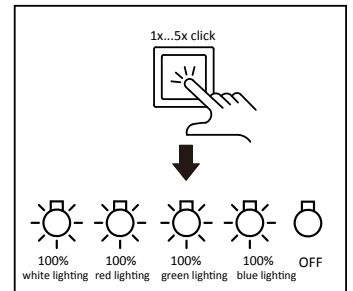
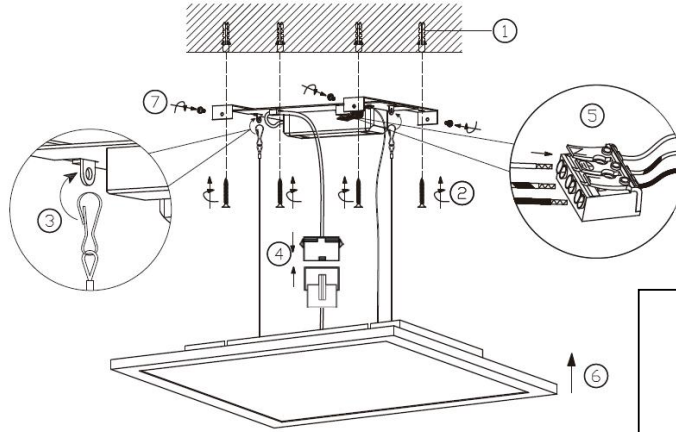
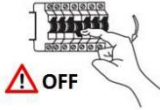

ARCCHIO

AUS/ OFF/ ARRÊT
 Nachtmodus (5% Helligkeit)
 Night mode (5% brightness)
 Veilleuse (luminosité de 5%)

STROBE: Schnelles Umschalten der Farben
 STROBE: fast color change
 STROBE : changement de couleur rapide

Helligkeit ↓ / brightness ↓ / la luminosité ↓

AN/ ON/ MARCHÉ
 Mehrfach drücken für die Farben rot, grün, blau, rot/grün, rot/blau, blau/grün, rot/grün/blau
 Press multiple times for the colors red, green, blue, red/green, red/blue, blue/green, red/green/blue
 Appuyez plusieurs fois pour les couleurs rouge, vert, bleu, rouge / vert, rouge / bleu, bleu / vert, rouge / vert / bleu

SMOOTH: langsames Überblenden der Farben
 SMOOTH: slow color change
 SMOOTH : changement de couleur lent

Helligkeit ↑ / brightness ↑ / la luminosité ↑

Kodierung der Fernbedienung/ coding of the remote control/ codage de la télécommande :
 Schalten Sie die Leuchte über den Wandschalter ein und drücken Sie innerhalb von 5 Sekunden die AUS-Taste schnell 2x hintereinander. Wenn das Licht erlischt, war die Kodierung erfolgreich. Sollte die Kodierung fehlschlagen, schalten Sie das Licht über den Wandschalter aus und warten Sie mindestens 5 Sekunden, ehe Sie es erneut versuchen.

Turn on the lamp by wall switch. Within 5 seconds, quickly press the OFF-button 2 times. If the light turns off, the match code is successful. If coding not success, please turn off the light and wait more than 5 seconds to try again.

Allumez la lumière sur l'interrupteur mural. Appuyez deux fois rapidement sur le bouton ARRÊT dans les 5 secondes. Lorsque la lumière s'éteint, cela signifie que la programmation a été réalisée avec succès. Si le codage a échoué, éteignez la lumière à l'aide de l'interrupteur mural. Attendez au moins 5 secondes avant d'essayer à nouveau.

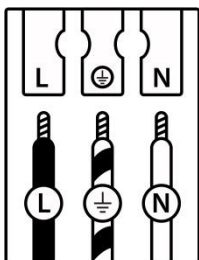
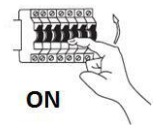

	(DE)	(GB)	(FR)	(NL)	(PL)	(NO)	(DK)
L	Stromführender Leiter	Live conductor	Conducteur	Spanning-voerende draad	Przewód prądowy	Strømførende leder	Strømførende leder
	Schutzleiter	Earth conductor	Conducteur de protection (terre)	Aardkabel	Przewód uziemiający	Jordledningen	Jordledningen
N	Neutralleiter	Neutral conductor	Conducteur neutre	Nulleider	Przewód zerowy	Nøytralleider	Neutralleider

	(SE)	(FI)	(IT)	(ES)	(CZ)	(PT)	(GR)
L	Strömförande ledare	Virtajohdin	Conduttore sotto tensione	Líneas conductoras de corriente	Vodič pod napětím	Condutor vivo	Ρευματοφόρος αγωγός
	Skyddsledare	Suojajohdin	Conduttore di terra	Conductor de protección	Ochranný vodič	Condutor de terra	Αγωγός γείωσης
N	Neutralledare	Nollajohdin	Conduttore neutro	Conductor neutro	Neutrální vodič	Condutor neutro	Ουδέτερος αγωγός

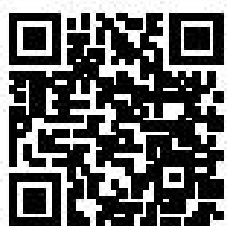
<p>(DE) Dieses Produkt enthält eine Lichtquelle der Energieeffizienzklasse F (EN) This product contains a light source of energy efficiency class F (FR) Ce produit comprend une source de lumière de classe d'efficacité énergétique F (NL) Dit product bevat een lichtbron van energie-efficiëntieklasse F (PL) Produkt ten zawiera źródło światła o klasie efektywności energetycznej F (NO) Dette produktet inneholder en lyskilde i energieeffektivitetsklasse F (DK) Dette produkt indeholder en lyskilde af energieeffektklasse F (SE) Denna produkt innehåller en ljuskälla i energieffektivitetsklass F (FI) Tämä tuote sisältää energiatehokkuusluokan F valonlähteen (IT) Questo prodotto contiene una sorgente luminosa della classe di efficienza energetica F (ES) Este producto contiene una fuente de luz de la clase de eficiencia energética F (CZ) Tento výrobek obsahuje světelný zdroj třídy energetické účinnosti F (PT) Este produto contém uma fonte de luz da classe de eficiência energética F (GR) Αυτό το προϊόν περιέχει μια φωτεινή πηγή ενεργειακής απόδοσης κλάσης F (SK) Tento výrobok obsahuje zdroj svetla triedy energetickej efektivity F</p>	<p>QR</p> 	<p>EAN</p> <p>4251911743067</p>
---	---	--

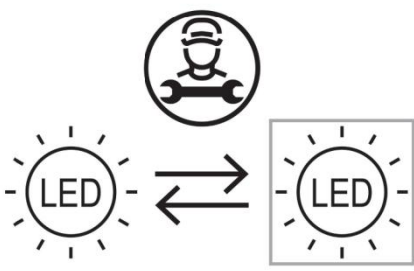
	<p>(DE) Durch einen Fachmann austauschbare Lichtquelle (nur LED) (EN) Replaceable (LED only) light source by a professional. (FR) Source de lumière remplaçable (LED uniquement) par un professionnel. (NL) Lichtbron (alleen led) te vervangen door een professional. (PL) Wymienne (tylko LED) źródło światła wykonane przez profesjonalistę. (NO) Utskiftbar (kun LED) lyskilde av en profesjonell. (DK) Udskiftelig lyskilde (kun LED), udskiftes af en elektriker. (SE) Ljuskälla (endast LED) utbytbar genom fackman. (FI) Ammatilainen voi vaihtaa vaihdettavan (vain LED) valonlähteen. (IT) Sorgente luminosa (solo LED) sostituibile da un professionista. (ES) Fuente de luz (solo LED) sustituible por un profesional. (CZ) Výměnitelný (pouze LED) světelný zdroj odborníkem. (PT) Luz LED (apenas LED) substituível por um profissional. (GR) Η πηγή φωτός (μόνο LED) να αντικαθίσταται από επαγγελματία. (SK) Zdroj svetla (iba LED) vymeniteľný prostredníctvom odborníka.</p>
--	---

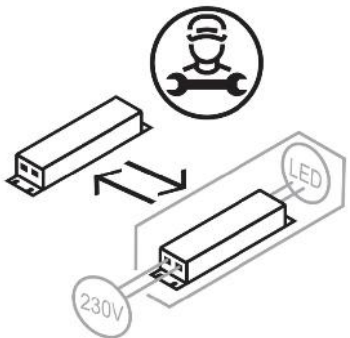
	<p>(DE) Durch einen Fachmann austauschbares Betriebsgerät. (EN) Replaceable control gear by a professional. (FR) Contrôleur remplaçable par un professionnel. (NL) Voorschakelapparatuur te vervangen door een professional. (PL) Wymienny układ sterujący przez profesjonalistę. (NO) Utskiftbar kontrollutstyr av en profesjonell. (DK) Udskiftelig igangsætter, udskiftes af en elektriker. (SE) Styrdon utbytbar genom fackman. (FI) Ammatilainen voi vaihtaa vaihdettavat ohjauslaitteet. (IT) Dispositivo di controllo sostituibile da un professionista. (ES) Dispositivo de control sustituible por un profesional. (CZ) Výměnitelný předřadník odborníkem. (PT) Dispositivo de controlo substituível por um profissional. (GR) Ο εξοπλισμός ελέγχου να αντικαθίσταται από επαγγελματία. (SK) Predradník vymeniteľný prostredníctvom odborníka.</p>
---	--