

10000878

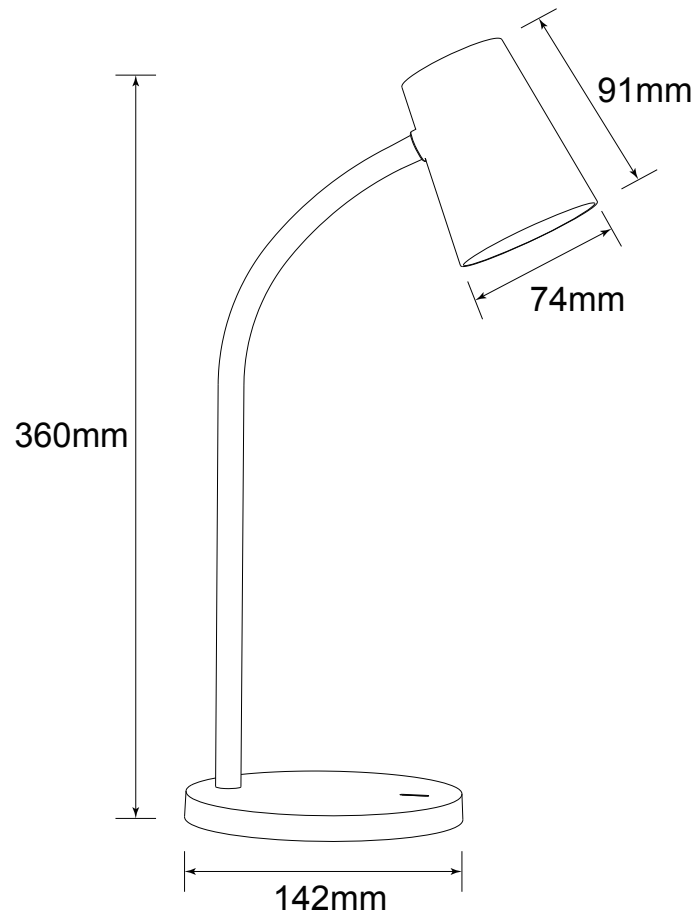



5W LED / 6,5W Total
incl. LED Board: L9002552
220-240V ~ 50/60Hz



(DE) Bestimmungsgemäße Verwendung

(EN) Intended use | (FR) Utilisation conforme | (NL) Beoogd gebruik | (PL) Stosowanie zgodnie z przeznaczeniem | (NO) Riktig bruk | (DK) Korrekt brug
(SE) Avsedd användning | (FI) Määräystenmukainen käyttö | (IT) Impiego appropriato | (ES) Uso prescrito | (CZ) Použití v souladu s určením
(PT) Utilização correta | (GR) Ενδεδειγμένη χρήση | (SK) Predpokladané použitie | (EE) Eeldatav kasutus | (LV) Paredzamais lietojums
(LT) Numatomas naudojimas | (RO) Utilizare intenționată | (SI) Predvidena uporaba | (HR) Namjenska upotreba | (HU) Tervezett felhasználás
(BG) предназначена употреба | (AL) Përdorimi i parashikuar | (MK) Предвидена употреба | (TR) Amaçlı kullanım | (UK) Призначене використання
(BA,ME,RS) Namjenska upotreba

(DE)	Als Tischleuchte im Innenbereich	(GB)	For use indoors as a table lamp
(FR)	En tant que lampe à poser, à l'intérieur	(NL)	Als tafellamp binnenshuis
(PL)	Jako lampa stołowa do wewnątrz	(NO)	Som bordlampe innendørs
(DK)	Som bordlampe indendørs	(SE)	Används som bordslampa inomhus
(FI)	Käyttö sisätilojen pöytävalaisimena	(IT)	Impiego come lampada da tavolo in ambienti interni
(ES)	Empleo en tanto lámpara de mesa en interiores	(CZ)	Použití jako stolní lampa v interiéru
(PT)	Aplicação como candeeiro de mesa em interiores	(GR)	Χρήση ως επιτραπέζιο φωτιστικό σε εσωτερικό χώρο
(SK)	Na použitie v interiéri ako stolová lampa	(BG)	За използване на закрито като настолна лампа
(EE)	kasutamiseks siseruumides lauualambina	(LV)	Izmantošanai iekštelpās kā galda lampu
(LT)	Naudoti patalpoje kaip stalinį šviestuvą	(RO)	Pentru utilizare în interior ca lampă de masă
(SI)	Za notranjo uporabo kot namizna svetilka	(HR)	Za upotrebu u zatvorenom prostoru kao stolna lampa
(HU)	Beltéri használatra asztali lámpaként	(AL)	Për përdorim brenda si llambë tavoline
(MK)	За употреба внатре како масна ламба	(TR)	Masa lambası olarak iç mekanda kullanım için
(UK)	Для використання всередині як настільна лампа	(BA)	Za upotrebu unutar kao stolna lampa
		(ME)	
		(RS)	

(DE) Lieferumfang		
(EN) Package contents (FR) Contenu de la livraison (NL) Bij de levering inbegrepen (PL) Zakres dostawy (NO) Levering (DK) Leveringsomfang (SE) Leveransomfattning (FI) Toimitussisältö (IT) Fornitura (ES) Volumen de suministro (CZ) Rozsah dodávky (PT) Material fornecido (GR) Παραδοτέος εξοπλισμός (SK) Obsah balenia (EE) Pakendi sisu (LV) Pakas saturs (LT) Pakuotės turinys (RO) Conținutul pachetului (SI) Vsebina paketa (HR) Sadržaj paketa (HU) A csomag tartalma (BG) обхват на доставката (AL) Përmbajtja e dorëzimit (MK) Содржина на испорака (TR) Teslimat içeriği (UK) Зміст доставки (BA,ME,RS) Sadržaj isporuke		
(DE) 1 Tischleuchte Montagematerial Montageanleitung	(GB) 1 Table lamp Installation hardware Mounting instructions	(FR) 1 Lampe à poser Matériel de montage Instructions de montage
(NL) 1 Tafellamp Monteringsmateriale Montagehandleiding	(PL) 1 Lampa stołowa Elementy montażowe Instrukcja montażu	(NO) 1 Bordlampe Monteringsmateriale Brukerveiledning
(DK) 1 Bordlampe Monteringsmateriale Brugervejledning	(SE) 1 Bordslampa Monteringsmaterial Monteringsanvisning	(FI) 1 Pöytävalaisin Asennusmateriaali Asennusohjeet
(IT) 1 Lampada da tavolo Materiale di montaggio Istruzioni di montaggio	(ES) 1 Lámpara de mesa Material de montaje Instrucciones de montaje	(CZ) 1 Stolní lampa Materiál pro montáž Návod k montáži
(PT) 1 Candeeiro de mesa Material de montagem Instruções de montagem	(GR) 1 Επιτραπέζιο φωτιστικό Υλικό συναρμολόγησης Οδηγίες συναρμολόγησης	(SK) 1 stolové svietidlo Inštalacný hardvér Inštalčná príručka
(BG) 1 настолна лампа материали за монтаж инструкции за монтаж	(EE) 1 laualamp Paigaldustarvikud Paigaldusjuhend	(LV) 1 galda lampa Instalācijas aparatūra Uzstādīšanas instrukcija
(LT) 1 stalinis šviestuvus Montavimo aparatinė įranga Montavimo instrukcija	(RO) 1 Lampă de masă Hardware de instalare Instrucțiuni de montare	(SI) 1 namizna svetilka Namestitvena strojna oprema Navodila za montažo
(HR) 1 Stolna lampa Instalacijski hardver Upute za montažu	(HU) 1 asztali lámpa Telepítési hardver Szerezési útmutató	(AL) 1 llambë tavoline Materiali i montimit Udhëzuesi i montimit
(MK) 1 ламба за маса Монтажен материјал Упатство за монтажа	(TR) 1 masa lambası Montaj malzemesi Montaj kılavuzu	(UK) 1 настільна лампа Монтажний матеріал Інструкція з монтажу
(BA) 1 stolna lampa (ME) Montažni materijal (RS) Uputstvo za montažu		

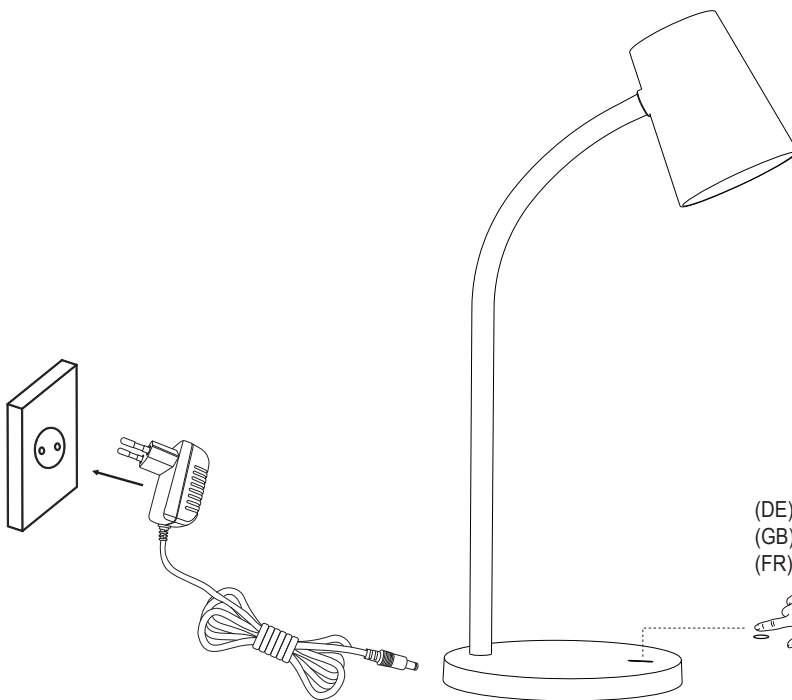
(DE) Verwendete Symbole	
(EN) Safety Precautions (FR) Symboles utilisés (NL) Gebruikte symbolen (PL) Stosowane symbole (NO) Brukte symboler (DK) Brugte symboler (SE) Använda symboler (FI) Käytetyt symbolit (IT) Simboli usati (ES) Símbolos empleados (CZ) Použité symboly (PT) Símbolos utilizados (GR) Χρησιμοποιούμενα σύμβολα (SK) Bezpečnostné opatrenia (EE) Ohutusabinõud (LV) Drošības pasākumi (LT) Saugos priemonės (RO) Măsuri de precauție (SI) Varnostni ukrepi (HR) Mjere opreza (HU) Használt szimbólumok (BG) Мерки за безопасност (AL) Simbolet e përdorura (MK) Користени симболи (TR) Kullanılan semboller (UK) Використовувані символи (BA,ME,RS) Korišteni simboli	
IP 20	   



(DE) Berührungsempfindlicher & dimmbarer Schalter, 10%—50%—100%
 (GB) Touch & Dimmable switch, 10%—50%—100%
 (FR) Interrupteur tactile et à gradation, 10%—50%—100%

<p>(DE) Dieses Produkt enthält eine Lichtquelle der Energieeffizienzklasse F (EN) This product contains a light source of energy efficiency class F (FR) Ce produit comprend une source de lumière de classe d'efficacité énergétique F (NL) Dit product bevat een lichtbron van energie-efficiëntieklasse F (PL) Produkt ten zawiera źródło światła o klasie efektywności energetycznej F (NO) Dette produktet inneholder en lyskilde i energieeffektivitetsklasse F (DK) Dette produkt indeholder en lyskilde af energieeffektklasse F (SE) Denna produkt innehåller en ljuskälla i energieeffektivitetsklass F (FI) Tämä tuote sisältää energiatehokkuusluokan F valonlähteen (IT) Questo prodotto contiene una sorgente luminosa della classe di efficienza energetica F (ES) Este producto contiene una fuente de luz de la clase de eficiencia energética F (CZ) Tento výrobek obsahuje světelný zdroj třídy energetické účinnosti F (PT) Este produto contém uma fonte de luz da classe de eficiência energética F (GR) Αυτό το προϊόν περιέχει μια φωτεινή πηγή ενεργειακής απόδοσης κλάσης F (SK) Tento výrobok obsahuje zdroj svetla triedy energetickej efektivity F (EE) See toode sisaldab energiatõhususklassi F valgusallikat (LV) Šis produkts satur enerģijas efektivitātes klases F gaismas avotu (LT) Šis gaminys turi energijos efektyvumo klasės F šviesos šaltinį (RO) Acest produs conține o sursă de lumină de clasă de eficiență energetică F (SI) Ta izdelek vsebuje svetlobni vir energijskega razreda F (HR) Ovaj proizvod sadrži izvor svjetlosti energetske učinkovitosti klase F (HU) Ez a termék egy F energiahatékonysági osztályú fényforrást tartalmaz (BG) Този продукт съдържа източник на светлина с клас на енергийна ефективност: F (AL) Ky produkt përmban një burim drite të klasës së efikasitetit të energjisë F (MK) Овој производ содржи извор на светлина од класа на енергетска ефикасност F (TR) Bu ürün, enerji verimliliği sınıfı F olan bir ışık kaynağı içerir (UK) Цей продукт містить джерело світла класу енергоефективності F (BA)(ME)(RS) Ovaj proizvod sadrži izvor svjetlosti energetske klase F</p>	<p>QR</p> 	<p>EAN</p> <p>4251911758948</p>
---	---	---------------------------------

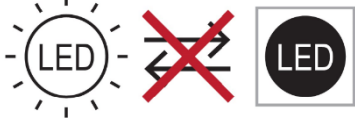
	<p>(DE) Die Lichtquelle dieser Leuchte ist nicht ersetzbar. (EN) The light source is not replaceable. (FR) La source lumineuse de cette lampe n'est pas remplaçable. (NL) De lichtbron van deze lamp is niet vervangbaar. (PL) Źródło światła w tej lampie jest niewymienne. (NO) Lyskilden i denne lampen er ikke mulig å bytte ut. (DK) Lyskilden til denne lampe kan ikke udskiftes. (SE) Ljuskällan i denna lampa är inbyggd och är inte utbytbar. (FI) Tämän valaisimen valonlähde ei voi vaihtaa. (IT) La sorgente luminosa di questa lampada non è sostituibile. (ES) La fuente de luz de esta lámpara no es reemplazable. (CZ) Světelný zdroj nelze vyměnit. (PT) A fonte de luz deste candeeiro não permite a substituição. (GR) Η πηγή φωτισμού αυτού του φωτιστικού δεν μπορεί να αντικατασταθεί. (SK) Svetelný zdroj tohto svetidla nie je vymeniteľný. (EE) Valgusallikat ei saa asendada. (LV) Gaismas avots nav aizstājams. (LT) Šviesos šaltinis nekeičiamas. (RO) Sursa de lumină nu poate fi înlocuită. (SI) Vir svetlobe ni zamenljiv. (HR) Izvor svjetla nije zamjenjiv. (HU) A fényforrás nem cserélhető ki. (BG) Източникът на светлина не може да се замени. (AL) Burimi i dritës nuk mund të zëvendësohet. (MK) Изворот на светлина не е заменлив. (TR) Işık kaynağı değiştirilemez. (UK) Джерело світла не можна замінити. (BA)(ME)(RS) Izvor svjetlosti nije zamjenjiv.</p>
---	--

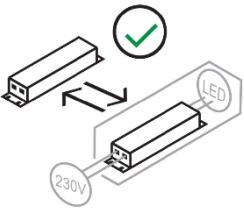
	<p>(DE) Durch einen Endverbraucher austauschbares Betriebsgerät. (EN) Replaceable control gear by an end-user. (FR) Contrôleur remplaçable (LED uniquement) par le consommateur. (NL) Voorschakelapparatuur te vervangen door consument. (PL) Wymienny osprzęt sterujący przez użytkownika końcowego. (NO) Utskiftbar kontrollutstyr av en sluttbruker. (DK) Udskiftelig igangsætter, kan udskiftes af slutbrugeren. (SE) Styrdon utbytbar genom slutkonsument. (FI) Loppukäyttäjän vaihdettavat ohjauslaitteet. (IT) Dispositivo di controllo sostituibile da un utente finale. (ES) Dispositivo de control sustituible por un usuario final. (CZ) Vyměnitelný předřadník koncovým uživatelem. (PT) Dispositivo de controlo substituível por um utilizador final. (GR) Ο εξοπλισμός ελέγχου να αντικαθίσταται από τον τελικό χρήστη. (SK) Predradník vymeniteľný prostredníctvom koncového používateľa. (EE) Asendatav juhtseade lõppkasutaja poolt. (LV) Aizstājams vadības aprīkojums lietotāja puse. (LT) Keičiamas valdymo įrenginys naudotojo. (RO) Echipament de comandă înlocuibil de către utilizatorul final. (SI) Zamenljiva krmilna oprema s strani končnega uporabnika. (HR) Zamjenjiva upravljačka oprema od strane krajnjeg korisnika. (HU) Cserélhető vezérlőberendezés a végfelhasználó által. (BG) Заменяемо управляващо оборудване от крайния потребител. (AL) Pajisje kontrolli e zëvendësueshme nga përdoruesi përfundimtar. (MK) Zamenлива kontrolna oprema od korisnikot. (TR) Son kullanıcı tarafından değiştirilebilir kontrol donanımları. (UK) Замінний керуючий пристрій від кінцевого користувача. (BA)(ME)(RS) Zamjenjiva kontrolna oprema od strane krajnjeg korisnika.</p>
---	---