

p

Pujol
iluminación

Pujol Iluminación S.L.
Indústria 13, 08980 Sant Feliu de Llobregat - Barcelona (Spain)
Tel. 34 93 685 7880 - Fax 34 93 685 1765
export@pujoliluminacion.com - comercial@pujoliluminacion.com
www.pujoliluminacion.com



A-914/120

LED Wandleuchte

Familie: ARCOS

Anwendungstyp: Wandleuchten

Diffusor: Methacrylat

Gehäuse: Aluminium

Farben:



B - Weiß



C - Chrome



Cu - Bronze



N - Schwarz



Nm - Matt Nickel



OX - Oxydbraun



PL - Silber

Lampentyp: LED 65W 9920lm 3000K

Dimmbar: JA, PHASSENABSCHNITSDIMMER

Schalter: NEIN

p

Pujol
iluminación

Pujol Iluminación S.L.
Indústria 13, 08980 Sant Feliu de Llobregat - Barcelona (Spain)
Tel. 34 93 685 7880 - Fax 34 93 685 1765
export@pujoliluminacion.com - comercial@pujoliluminacion.com
www.pujoliluminacion.com

Spezifikationen

IP20

RF 850°



Installation auf brennbaren Oberflächen



Klasse I

Optionen:

Klasse II, IP44, LED 4000K, LED 2700K

Abmessungen:

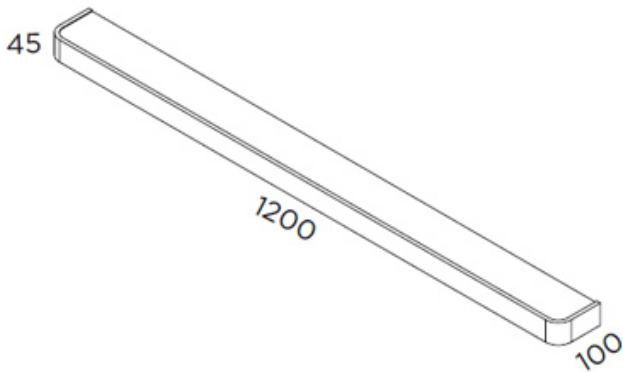

Effizienz label:

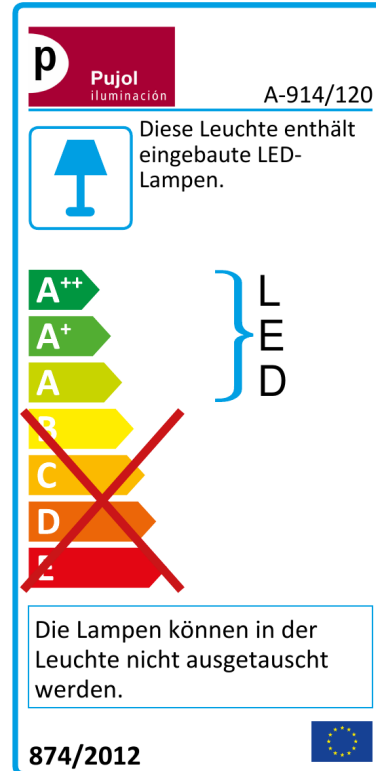

p

Pujol
iluminación

Pujol Iluminación S.L.
Indústria 13, 08980 Sant Feliu de Llobregat - Barcelona (Spain)
Tel. 34 93 685 7880 - Fax 34 93 685 1765
export@pujoliluminacion.com - comercial@pujoliluminacion.com
www.pujoliluminacion.com

Mehr Bilder:

