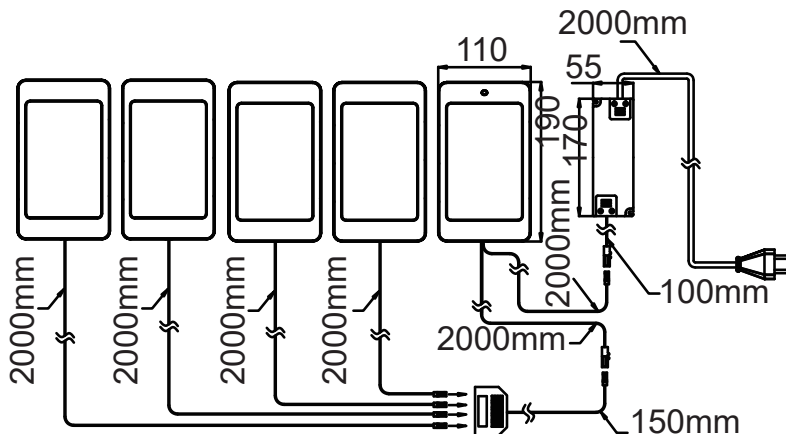

9934127

5x 4,8W LED / 25W Total
incl. 5x LED Board: L9002399
220-240V ~ 50Hz

**(DE) Bestimmungsgemäße Verwendung**

(GB) Intended use / (FR) Utilisation conforme / (NL) Beoogd gebruik / (PL) Stosowanie zgodnie z przeznaczeniem /
(NO) Riktig bruk / (DK) Korrekt brug / (SE) Avsedd användning / (FI) Määräystenmukainen käyttö

(IT) Impiego appropriato / (ES) Uso prescrito / (CZ) Použití v souladu s určením / (PT) Utilização correta / (GR) Ενδειγμένη χρήση

(DE)	Ortsfeste Verwendung als Unterbauleuchte im Innenbereich	(GB)	Provided for stationary use as under-cabinet light, indoors
(FR)	Installation fixe en tant que lampe sous meuble à l'intérieur	(NL)	Vast gebruik als meubelverlichting binnenshuis
(PL)	Do montażu stacjonarnego jako oprawa podszafkowa do wnętrza	(NO)	Til stasjonært bruk som påbygningslampe til møbler innendørs
(DK)	Til stationær brug som påbygningslampe til møbler indendørs	(SE)	Används som fast möbelpåbyggnadslampa inomhus
(FI)	Kiinteä käyttö sisätilojen pinta-asennettavana kalustevalaisimena	(IT)	Impiego fisso come lampada da mobile in ambienti interni
(ES)	Empleo fijo en tanto lámpara bajo mueble en interiores	(CZ)	Stacionární použití jako nábytkové osvětlení v interiéru
(PT)	Aplicação fixa como luminária de móveis de montagem à superfície em interiores	(GR)	Σταθερή χρήση ως ενσωματωμένο φωτιστικό επίπλων σε εσωτερικό χώρο

(DE) Verwendete Symbole

(GB) Safety Precautions / (FR) Symboles utilisés / (NL) Gebruikte symbolen / (PL) Stosowane symbole / (NO) Brukte symboler /
(DK) Brugte symboler / (SE) Använda symboler / (FI) Käytetyt symbolit / (IT) Simboli usati / (ES) Símbolos empleados /
(CZ) Použité symboly / (PT) Símbolos utilizados / (GR) Χρησιμοποιούμενα σύμβολα

IP 20

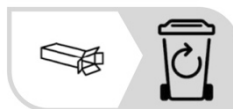
**(DE) Lieferumfang**

(GB) Package contents / (FR) Contenu de la livraison / (NL) Bij de levering inbegrepen / (PL) Zakres dostawy / (NO) Levering /
(DK) Leveringsomfang / (SE) Leveransomfattning / (FI) Toimitussisältö / (IT) Fornitura / (ES) Volumen de suministro /
(CZ) Rozsah dodávky / (PT) Material fornecido / (GR) Παραδοτέος εξοπλισμός

(DE)	1 Unterbauleuchte Montagematerial Montageanleitung	(GB)	1 under-cabinet light Installation hardware Mounting instructions	(FR)	1 lampe sous meuble Matériel de montage Instructions de montage
(NL)	1 meubelverlichting Monteringsmateriale Montagehandleiding	(PL)	1 oprawa podszafkowa Elementy montażowe Instrukcja montażu	(NO)	1 Påbygningslampe til møbler Monteringsmateriale Brukerveiledning
(DK)	1 Påbygningslampe til møbler Monteringsmateriale Brugervejledning	(SE)	1 Möbelpåbyggnadslampa Monteringsmateriale Monteringsanvisning	(FI)	1 Pinta-asennettava kalustevalaisin Asennusmateriaali Asennusohjeet
(IT)	1 Lampada da mobile Materiale di montaggio Istruzioni di montaggio	(ES)	1 Lámpara bajo mueble Material de montaje Instrucciones de montaje	(CZ)	1 Nábytkové svítidlo Materiál pro montáž Návod k montáži
(PT)	1 Luminária de móveis de montagem à superfície Material de montagem Instruções de montagem	(GR)	1 Ενσωματωμένο φωτιστικό επίπλων Υλικό συναρμολόγησης Οδηγίες συναρμολόγησης		

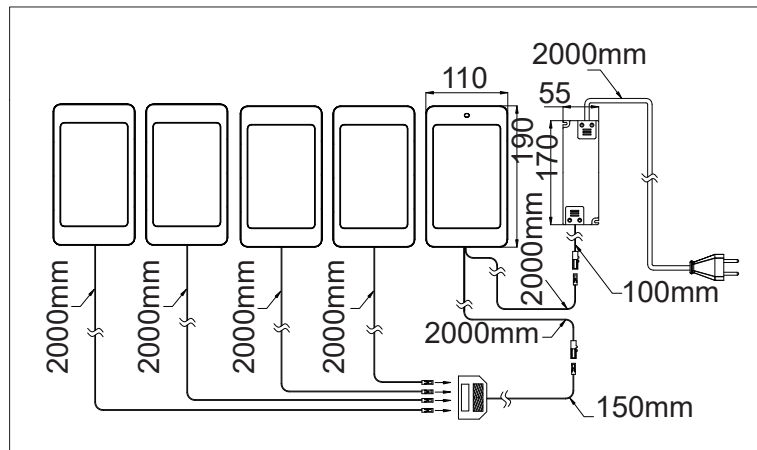
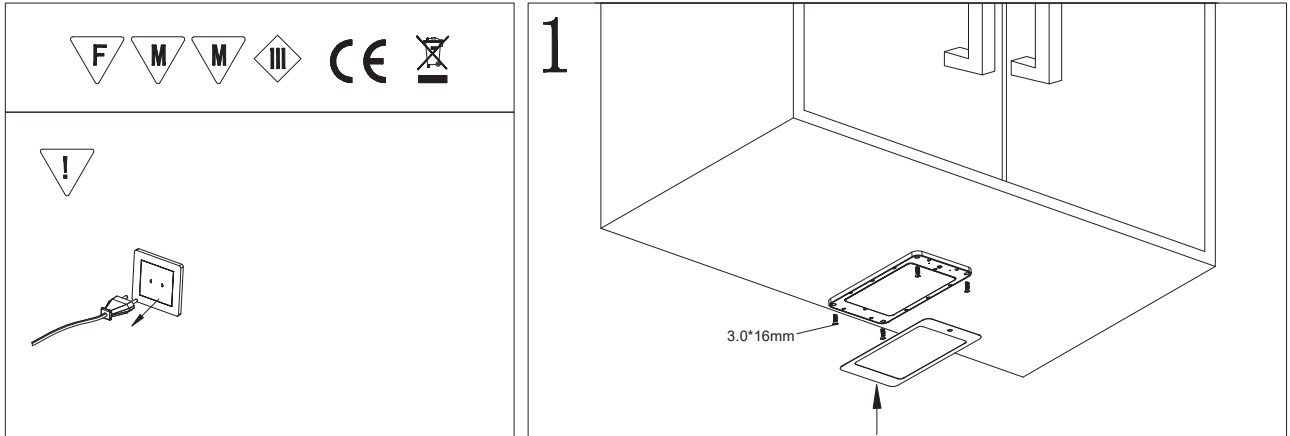

(DE)

Handwinkelsensor

Halten Sie Ihre Hände kurz vor den Sensor, um ihn ein-/auszuschalten.

Halten Sie Ihre Hände dauerhaft vor den Sensor, um die Helligkeit langsam hoch- oder runterzudimmen.

Entfernen Sie die Hände, um die Helligkeitsänderung zu stoppen.

Legen Sie Ihre Hände erneut vor den Sensor, um die Helligkeit von oben nach unten oder von unten nach oben zu ändern.

(GB)

Hand wave sensor

Put your hands in the front of sensor shortly to on/off.

put your hands in the front of sensor permanently to dimming slowly the brightness up or down.

Remove the hands to stop the brightness change.

Put your hands again to change the brightness from up to down or down to up.

(FR)

Détecteur de mouvement de la main

Placez vos mains devant le capteur pour l'allumer ou l'éteindre brièvement.

Placez vos mains devant le capteur de façon permanente pour faire varier lentement la luminosité vers le haut ou vers le bas.

Retirez les mains pour arrêter le changement de luminosité.

Placez à nouveau vos mains devant le capteur pour faire varier la luminosité de haut en bas ou de bas en haut.

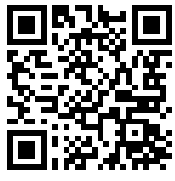
<p>(DE) Dieses Produkt enthält eine Lichtquelle der Energieeffizienzklasse G (EN) This product contains a light source of energy efficiency class G (FR) Ce produit comprend une source de lumière de classe d'efficience énergétique G (NL) Dit product bevat een lichtbron van energie-efficiëntieklasse G (PL) Produkt ten zawiera źródło światła o klasie efektywności energetycznej G (NO) Dette produktet inneholder en lyskilde i energieeffektivitetsklasse G (DK) Dette produkt indeholder en lyskilde af energieeffektklasse G (SE) Denna produkt innehåller en ljuskälla i energieffektivitetsklass G (FI) Tämä tuote sisältää energiatehokkuusluokan G valonlähteen (IT) Questo prodotto contiene una sorgente luminosa della classe di efficienza energetica G (ES) Este producto contiene una fuente de luz de la clase de eficiencia energética G (CZ) Tento výrobek obsahuje světelný zdroj třídy energetické účinnosti G (PT) Este produto contém uma fonte de luz da classe de eficiência energética G (GR) Αυτό το προϊόν περιέχει μια φωτεινή πηγή ενεργειακής απόδοσης κλάσης G (SK) Tento výrobok obsahuje zdroj svetla triedy energetickej efektivity G</p>	<p>QR</p> 	<p>EAN</p> <p>4251911752601</p>
---	--	--

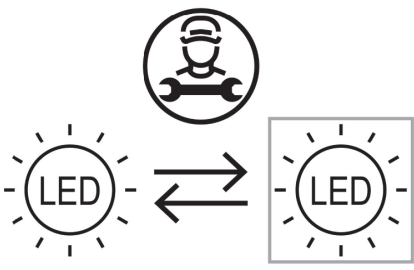
	<p>(DE) Durch einen Fachmann austauschbare Lichtquelle (nur LED). (EN) Replaceable (LED only) light source by a professional. (FR) Source de lumière remplaçable (LED uniquement) par un professionnel. (NL) Lichtbron (alleen led) te vervangen door een professional. (PL) Wymienne (tylko LED) źródło światła wykonane przez profesjonalistę. (NO) Utskiftbar (kun LED) lyskilde av en profesjonell. (DK) Udskiftelig lyskilde (kun LED), udskiftes af en elektriker. (SE) Ljuskälla (endast LED) utbytbar genom fackman. (FI) Ammattilainen voi vaihtaa vaihdettavan (vain LED) valonlähteen. (IT) Sorgente luminosa (solo LED) sostituibile da un professionista. (ES) Fuente de luz (solo LED) sustituible por un profesional. (CZ) Vyměnitelný (pouze LED) světelný zdroj odborníkem. (PT) Luz LED (apenas LED) substituível por um profissional. (GR) Η πηγή φωτός (μόνο LED) να αντικαθίσταται από επαγγελματία. (SK) Zdroj svetla (iba LED) vymeniteľný prostredníctvom odborníka.</p>
--	---

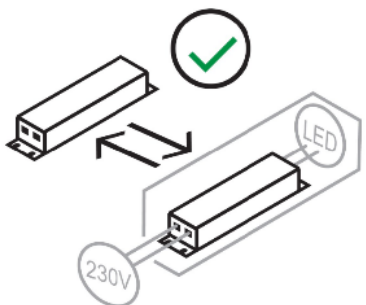
	<p>(DE) Durch einen Endverbraucher austauschbares Betriebsgerät. (EN) Replaceable control gear by an end-user. (FR) Contrôleur remplaçable (LED uniquement) par le consommateur. (NL) Voorschakelapparatuur te vervangen door consument. (PL) Wymienny osprzęt sterujący przez użytkownika końcowego. (NO) Utskiftbar kontrollutstyr av en sluttbruker. (DK) Udskiftelig igangsætter, kan udskiftes af slutbrugeren. (SE) Styrdon utbytbar genom slutkonsument. (FI) Loppukäyttäjän vaihdettavat ohjauslaitteet. (IT) Dispositivo di controllo sostituibile da un utente finale. (ES) Dispositivo de control sustituible por un usuario final. (CZ) Vyměnitelný předřadník koncovým uživatelem. (PT) Dispositivo de controlo substituível por um utilizador final. (GR) Ο εξοπλισμός ελέγχου να αντικαθίσταται από τον τελικό χρήστη. (SK) Predradník vymeniteľný prostredníctvom koncového používateľa.</p>
---	---