

Paul Neuhaus

Paul Neuhaus GmbH  
Olakenweg 36 · 59457 Werl  
Germany

Telefon: +49 (0) 29 22-97 21-0  
Telefax: +49 (0) 29 22-97 21-9120  
E-mail: info@neuhaus-group.de  
<https://scm.paul-neuhaus.de/public/conformity/>



D | Montageanleitung • GB | Fitting instructions

- DE** Dieses Produkt enthält eine Lichtquelle der Energieeffizienzklasse <E>.
- GB** This product contains a light source of energy efficiency class <E>.
- FR** Ce produit comprend une source de lumière de classe d'efficacité énergétique <E>.
- BG** Продуктът съдържа източник на светлина с клас на енергийна ефективност <E>.
- CZ** Tento výrobek obsahuje světelný zdroj třídy energetické účinnosti <E>.
- DK** Dette produkt indeholder en lyskilde af energieeffektklasse <E>.
- EL** Αυτό το προϊόν περιέχει πηγή φωτός της τάξης ενεργειακής απόδοσης <E>.
- ES** Este producto contiene una fuente de luz de la clase de eficiencia energética <E>.
- ET** See toode sisaldab valgusallikat energiatõhususklassiga <E>.
- FI** Tämä tuote sisältää energiatehokkuusluokan <E> valonlähteen.
- HR** Ovaj proizvod sadrži izvor svjetlosti energetskeg razreda <E>.
- HU** Ez a termék <E> energiahatákonysági osztályba tartozó fényforrást tartalmaz.
- IT** Questo prodotto contiene una sorgente luminosa della classe di efficienza energetica <E>.
- LT** Šis produktas yra su šviesos šaltiniu, kurio energinio efektyvumo klasė yra <E>.
- LV** Šis izstrādājums satur gaismas avotu, kas atbilst energoefektivitātes klasei <E>.
- NL** Dit product bevat een lichtbron van energie-efficiëntieklasse <E>.
- NO** Dette produktet inneholder en lyskilde i energieffektivitetsklasse <E>.
- PL** Produkt ten zawiera źródło światła o klasie efektywności energetycznej <E>.
- PT** Este produto contém uma fonte de luz da classe de eficiência energética <E>.
- RO** Acest produs conține o sursă de lumină din clasa de eficiență energetică <E>.
- RU** Данное изделие содержит источник света класса энергоэффективности <E>.
- SK** Tento výrobek obsahuje zdroj svetla triedy energetickej efektivity <E>.
- SL** Ta izdelek vsebuje svetlobni vir razreda energijske učinkovitosti <E>.
- SR** Ovaj proizvod sadrži izvor svetlosti energetske klase <E>.
- SV** Denna produkt innehåller en ljuskälla i energieffektivitetsklass <E>.
- TR** Bu ürün, enerji verimliliği sınıfına sahip bir ışık kaynağı içerir <E>.

835801

230V/50Hz~  
1x LED-Board 24V DC / 69W  
nicht wechselbar / not changeable



2,4 GHz  
10 dBm

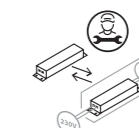
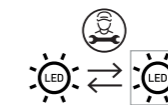

	69 W
	8.500 lm
	78 W
	2.850 lm
	LED-Board
<b>t</b>	25.000 h
<b>Tk</b>	2.700-5.000 K
	15.000 x
	<0,5 s
	dimmable with rrc

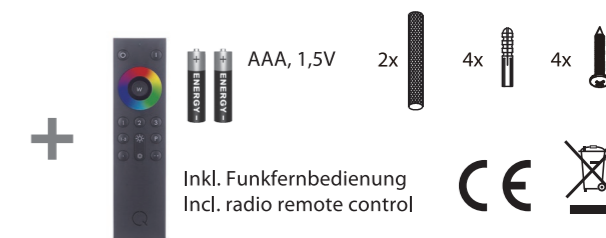
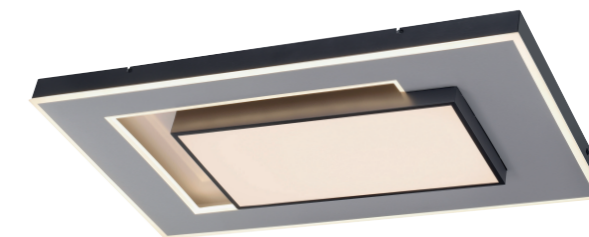

Inkl. Funkfernbedienung  
Incl. radio remote control



## 1 | Montage / fitting

als Deckenleuchte  
as ceiling light

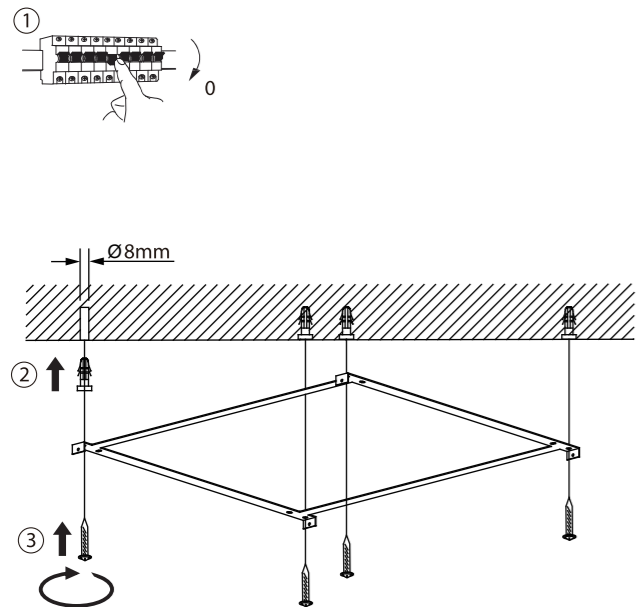

## 2 | Elektrischer Anschluss / electrical connection

230 Volt/50 Hz-Anschluss  
230 voltage/50 Hz connection

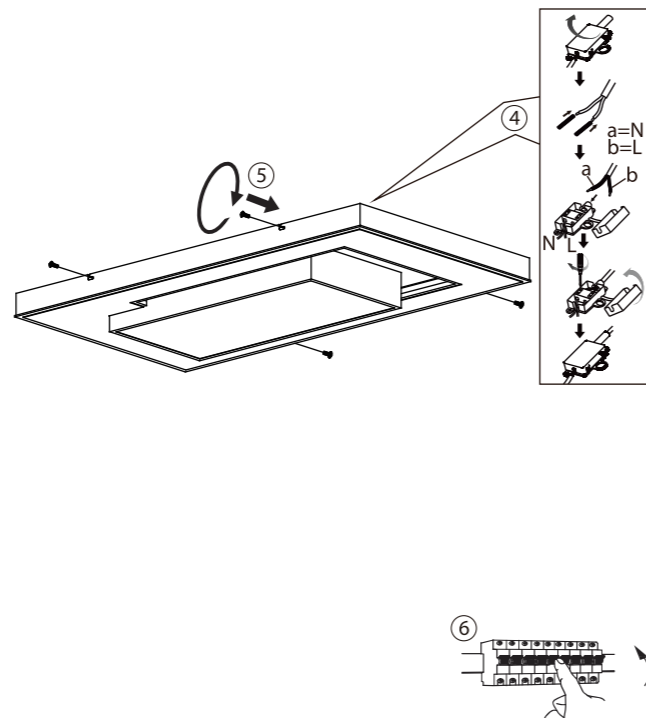

## 3 | Fernbedienung anlernen / teach remote control

Siehe Q-Fernbedienungsanleitung  
See Q-remote control manual

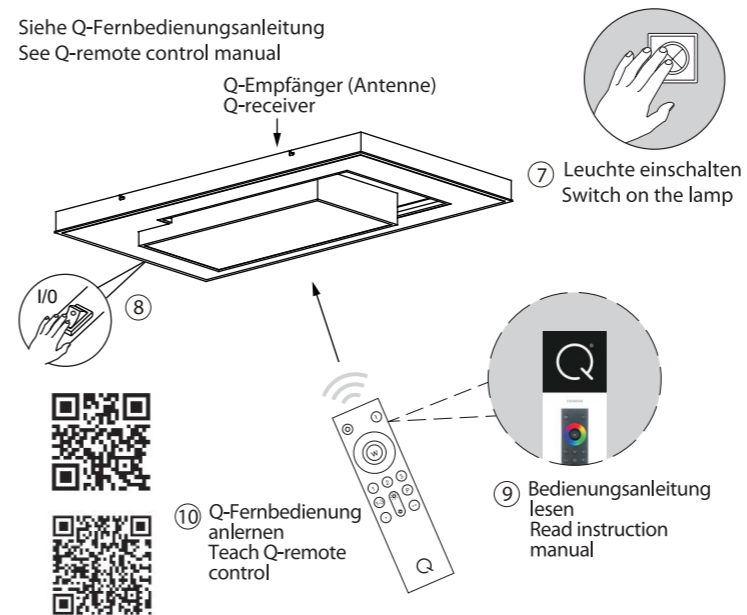

### Reset

Rückstellen der Leuchte auf Werkseinstellung  
Reset the lamp, factory new

5 x on/off

