

96284321x E14 max. 10W LED
230V ~ 50Hz**(DE) Bestimmungsgemäße Verwendung**

(GB) Intended use / (FR) Utilisation conforme / (NL) Beoogd gebruik / (PL) Stosowanie zgodnie z przeznaczeniem / (NO) Riktig bruk / (DK) Korrekt brug / (SE) Avsedd användning / (FI) Määräystenmukainen käyttö

(IT) Impiego appropriato / (ES) Uso prescrito / (CZ) Použití v souladu s určením / (PT) Utilização correta / (GR) Ενδεδειγμένη χρήση

(DE)	Verwendung als Schienenstrahler im Innenbereich	(GB)	Provided for indoor use as track spotlight
(FR)	Utilisation comme spot sur rail à l'intérieur	(NL)	Gebruik als railstraler binnenshuis
(PL)	Do montażu jako reflektor szynowy do wewnątrz	(NO)	Til bruk som skinnerspot innendørs
(DK)	Til brug som strømskinne spot indendørs	(SE)	Används som skenspotlight inomhus
(FI)	Kohdevalaisin 1-vaihejärjestelmään	(IT)	Impiego fisso come spot per binario in ambienti interni
(ES)	Empleo fijo en tanto sistema de riel spot en interiores	(CZ)	Stacionární použití jako reflektor v interiéru
(PT)	Aplicação fixa como holofotes trilha em interiores	(GR)	Σταθερή χρήση ως φωτιστικό οροφής σε εσωτερικό χώρο

(DE) Verwendete Symbole

(GB) Safety Precautions / (FR) Symboles utilisés / (NL) Gebruikte symbolen / (PL) Stosowane symbole / (NO) Brukte symboler / (DK) Brugte symboler / (SE) Använda symboler / (FI) Käytetyt symbolit / (IT) Simboli usati / (ES) Símbolos empleados / (CZ) Použité symboly / (PT) Símbolos utilizados / (GR) Χρησιμοποιούμενα σύμβολα

IP 20

**(DE) Lieferumfang**

(GB) Package contents / (FR) Contenu de la livraison / (NL) Bij de levering inbegrepen / (PL) Zakres dostawy / (NO) Levering / (DK) Leveringsomfang / (SE) Leveransomfattning / (FI) Toimitussisältö / (IT) Fornitura / (ES) Volumen de suministro / (CZ) Rozsah dodávky / (PT) Material fornecido / (GR) Παραδοτέος εξοπλισμός

(DE)	1 Schienenstrahler Montagematerial Montageanleitung	(GB)	1 track spotlight Installation hardware Mounting instructions	(FR)	1 spot sur rail Matériel de montage Instructions de montage
(NL)	1 railstraler Monteringsmateriale Montagehandleiding	(PL)	1 reflektor szynowy Elementy montażowe Instrukcja montażu	(NO)	1 skinnerspot Monteringsmateriale Brukerveiledning
(DK)	1 strømskinne spot Monteringsmateriale Brugervejledning	(SE)	1 skenspotlight Monteringsmaterial Monteringsanvisning	(FI)	1 Kohdevalaisin Asennusmateriaali Asennusohjeet
(IT)	1 spot per binario Materiale di montaggio Istruzioni di montaggio	(ES)	1 sistema de riel spot Material de montaje Instrucciones de montaje	(CZ)	1 Stropní svítidlo Materiál pro montáž Návod k montáži
(PT)	1 Luminária de teto Material de montagem Instruções de montagem	(GR)	1 Φωτιστικό οροφής Υλικά συναρμολόγησης Οδηγίες συναρμολόγησης		

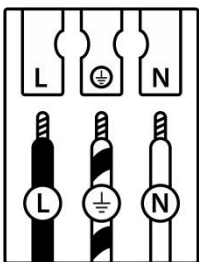
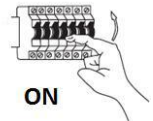
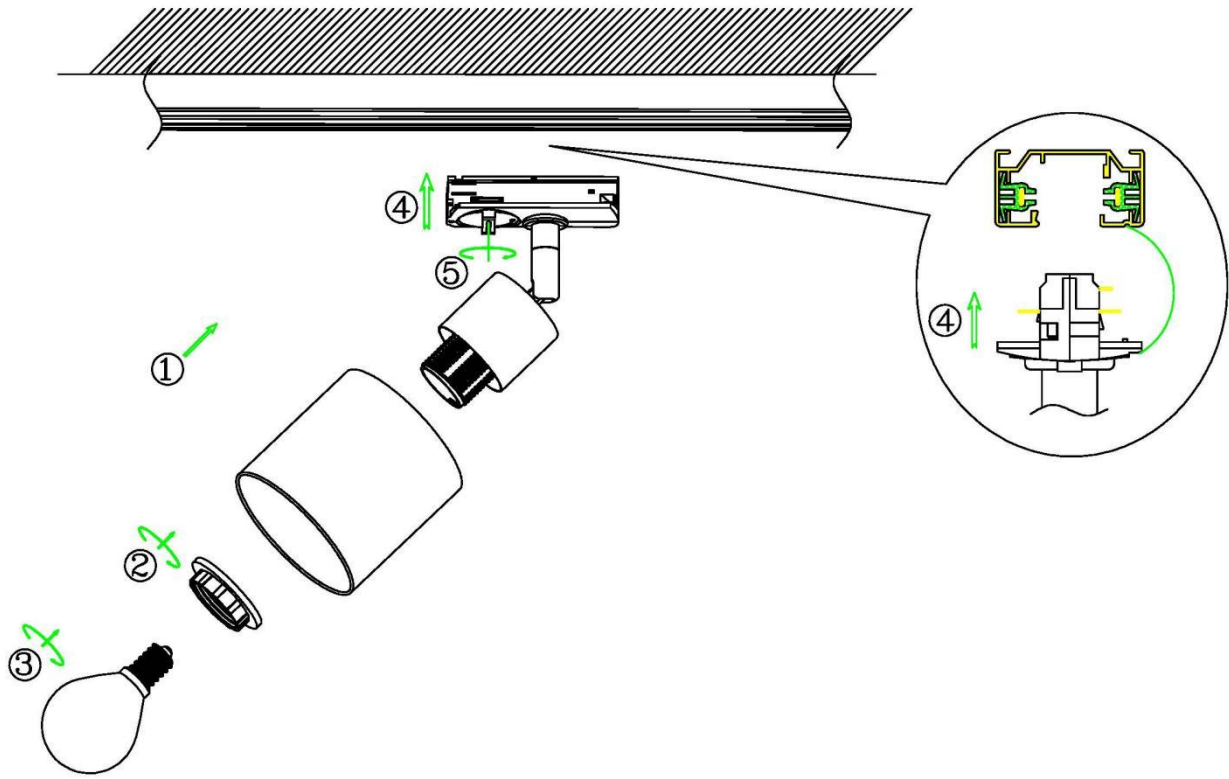
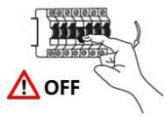

	(DE)	(GB)	(FR)	(NL)	(PL)	(NO)	(DK)
L	Stromführender Leiter	Live conductor	Conducteur	Spanningvoerende draad	Przewód prądowy	Strømførende leder	Strømførende leder
	Schutzleiter	Earth conductor	Conducteur de protection (terre)	Aardkabel	Przewód uziemiający	Jordledningen	Jordledningen
N	Neutralleiter	Neutral conductor	Conducteur neutre	Nulleider	Przewód zerowy	Nøytralleder	Neutrallerder

	(SE)	(FI)	(IT)	(ES)	(CZ)	(PT)	(GR)
L	Strömförande ledare	Virtajohdin	Conduttore sotto tensione	Líneas conductoras de corriente	Vodič pod napětím	Condutor vivo	Ρευματοφόρος αγωγός
	Skyddsledare	Suojajohdin	Conduttore di terra	Conductor de protección	Ochranný vodič	Condutor de terra	Αγωγός γείωσης
N	Neutralledare	Nollajohdin	Conduttore neutro	Conductor neutro	Neutrální vodič	Condutor neutro	Ουδέτερος αγωγός

Circuit Track Adaptor Manual

Instructions

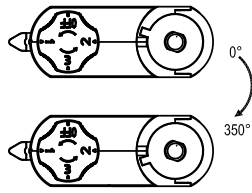
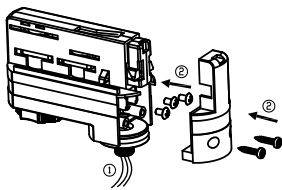

Fixture Nipple Rotation range:0-350°

POWERGEAR 3-Circuit Track Adaptor is universal compatible. It will work with the following brand track: STAFF, NORLUX, GLOBAL, NUCO AND NORDIC.

ONE PART ADAPT IT ALL!

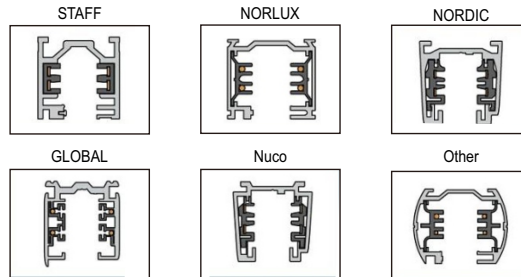

1. Wire: 0.75mm², 18AWG

2. Screws assembly to withstand Torque: **5kgf.cm**

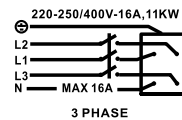
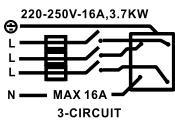
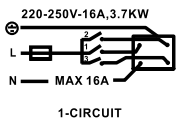

Installation Instructions

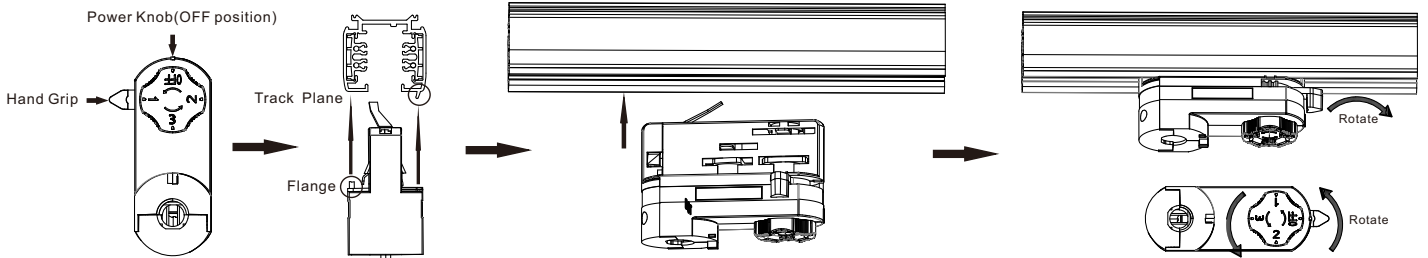

1. Make sure the positions are exactly the same as the pictures show before installation.

2. The adaptor flange is in the same direction with the track plane.

3. Track adaptor into the track

4. Revolve the hand grip in place, select the power knob: phase 1/phase 2/ phase 3. Can swing clockwise and anticlockwise.

Remove Instructions

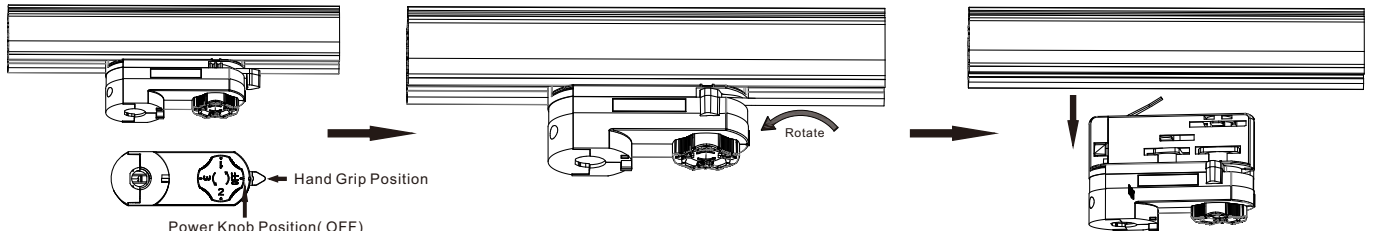

1. Make sure the track adaptor's positions are the same as the picture shows before removing.

2. When power knob at the "OFF" position, rotate the hand grip at 90 degree.

3. Remove the track adaptor.

Cautions

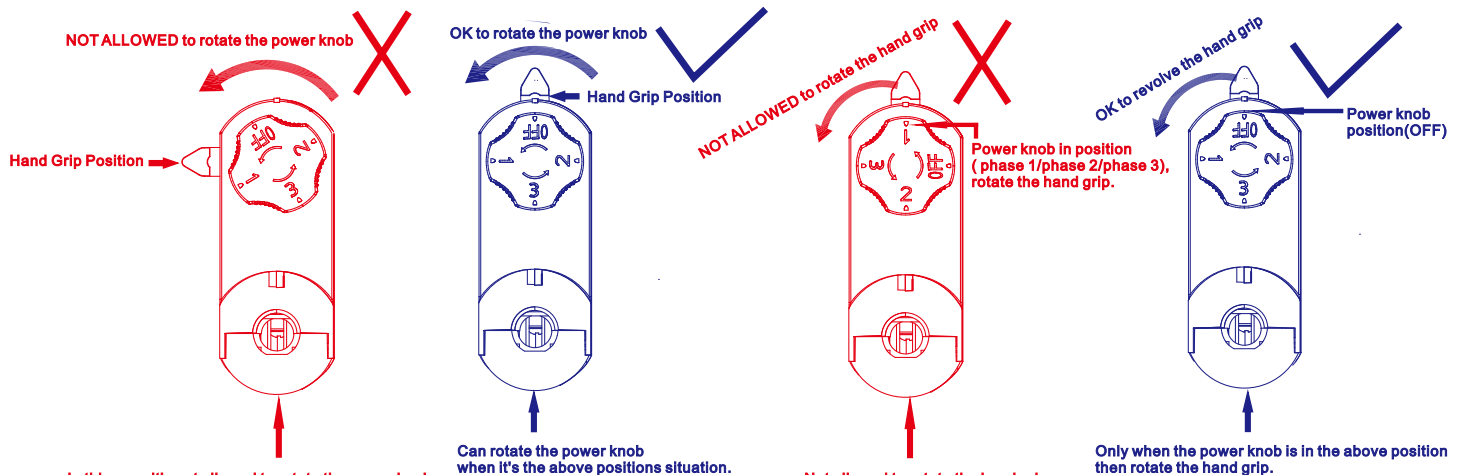

(Before Installation)

(Before Remove)

Phasen-Schienenadapter Handbuch

Anweisungen

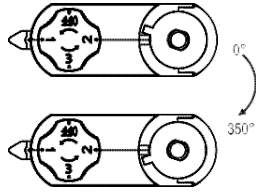
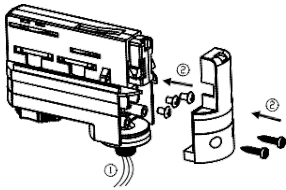

Halterung Nippel Rotationsbereich: 0~350°

Der POWERGEAR 3-Circuit Track Adapter ist universell kompatibel und funktioniert mit den folgenden Markenschienen: STAFF, NORLUX, GLOBAL, NUCO AND NORDIC.

EIN TEIL PASST ALLES AN!

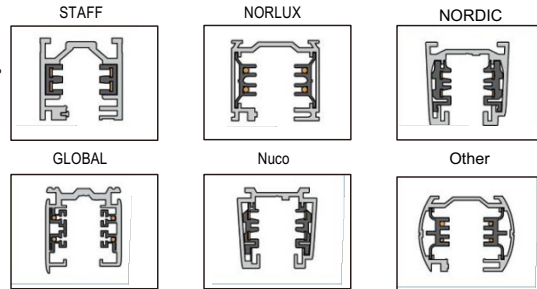

1. Draht: 0,75mm²18AWG
2. Schrauben, die dem Drehmoment standhalten: 5kgf.cm

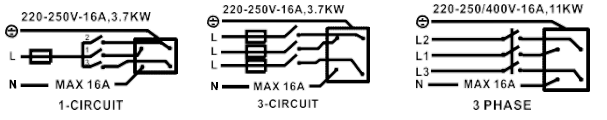

Installationsanweisungen

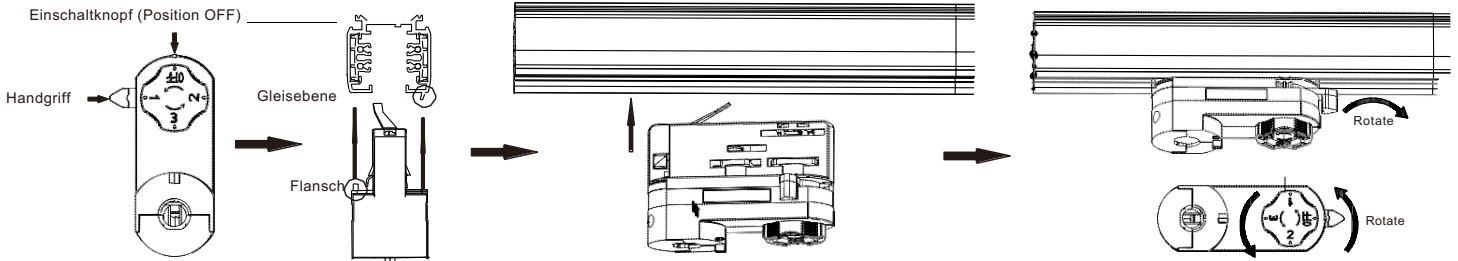

1. Vergewissern Sie sich vor der Installation, dass die Positionen genau mit den Abbildungen übereinstimmen.
2. Der Flansch des Adapters liegt in der gleichen Richtung wie die Schienenebene.
3. Den Adapter in das Gleis einführen.
4. Drehen Sie den Handgriff an Ort und Stelle, wählen Sie den Leistungsknopf: Phase 1/Phase 2/Phase 3. Kann im Uhrzeigersinn und gegen den Uhrzeigersinn gedreht werden.

Anweisungen entfernen

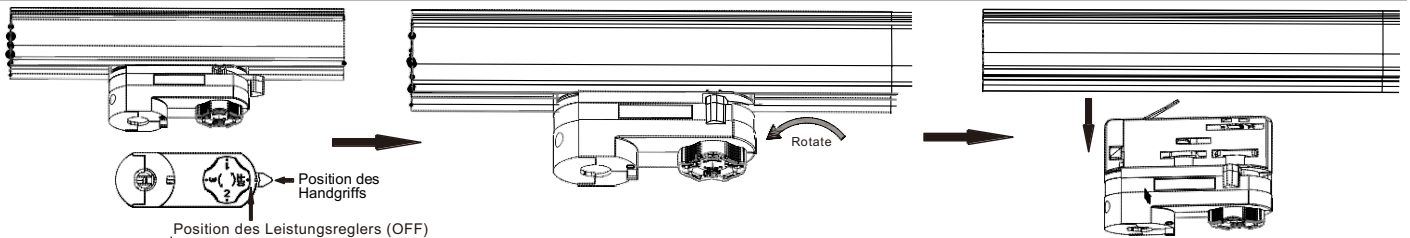

1. Vergewissern Sie sich, dass die Position des Schienenadapters mit der Abbildung übereinstimmt, bevor Sie ihn entfernen.
2. Drehen Sie den Handgriff um 90 Grad, wenn der Einschaltknopf auf "OFF" steht.
3. Entfernen Sie den Raupenadapter.

Vorsichtsmaßnahmen

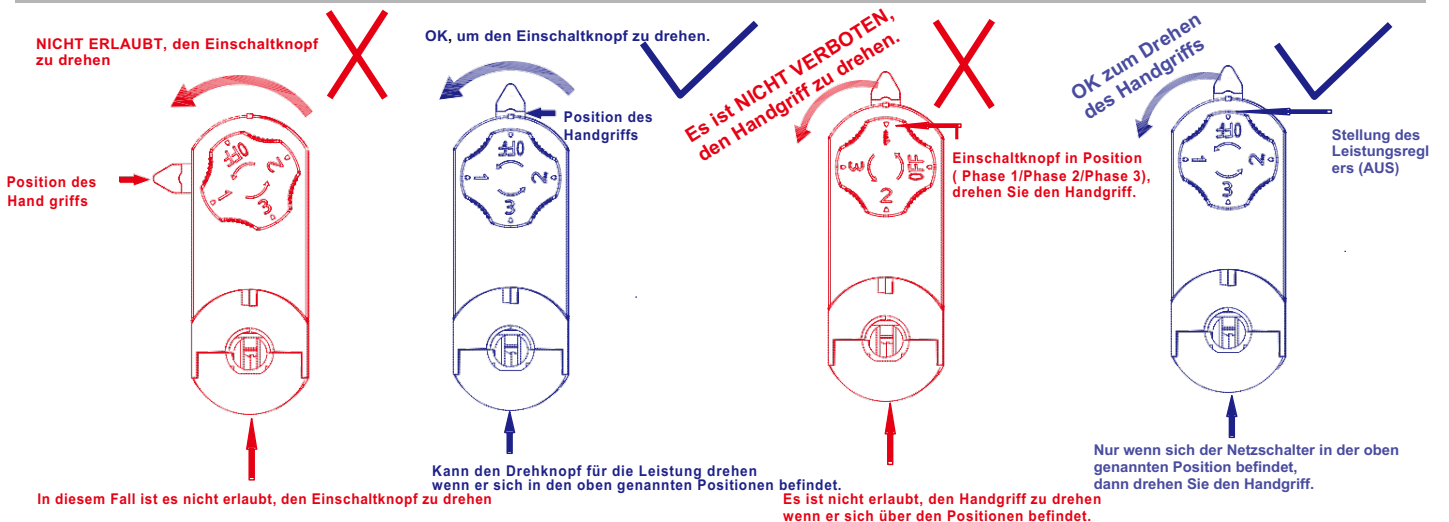

(Vor der Instalation)

(Vor Entfernen)

Manuel de l'adaptateur de piste

Instructions

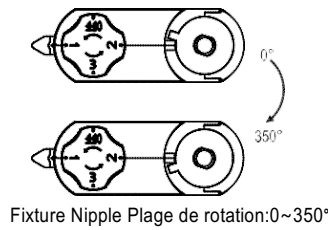
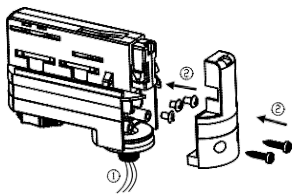

POWERGEAR 3-Circuit Track Adaptor est compatible avec les marques de rails suivantes:
STAFF, NORLUX, GLOBAL, NUCO AND NORDIC.

UNE PARTIE S'ADAPTE À TOUT!

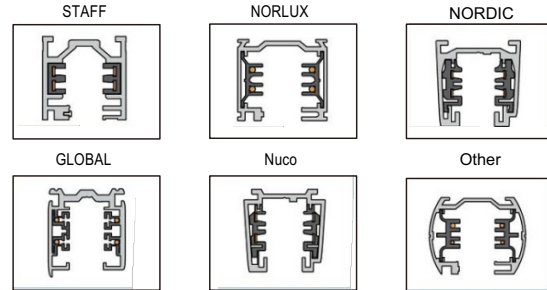

- Fil: 0.75mm², 18AWG
- Assemblage des vis pour résister au couple: **5kgf.cm**

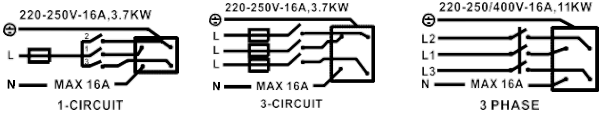

Instructions d'installation

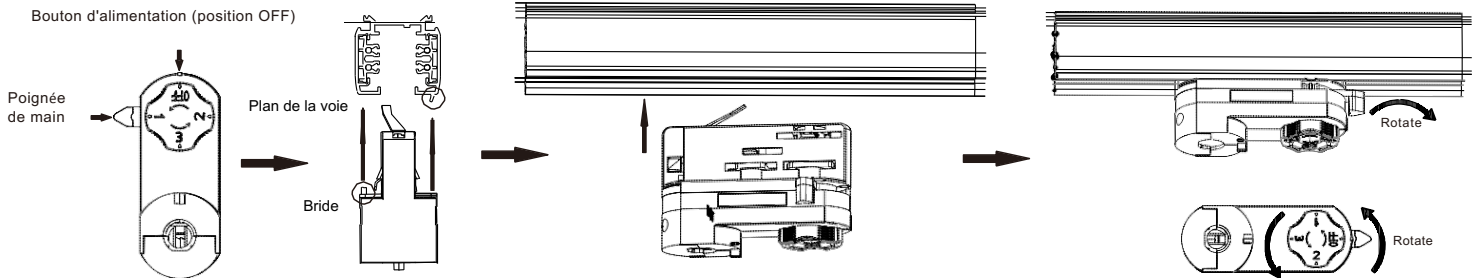

- Assurez-vous que les positions sont exactement les mêmes que celles indiquées sur les photos avant de procéder à l'installation
- La bride de l'adaptateur est dans la même direction que le plan du rail.
- Insérez l'adaptateur dans la voie.
- Tournez la poignée en place, sélectionnez le bouton de puissance : phase 1/phase 2/phase 3. Peut pivoter dans le sens des aiguilles d'une montre et dans le sens inverse.

Retirer les instructions

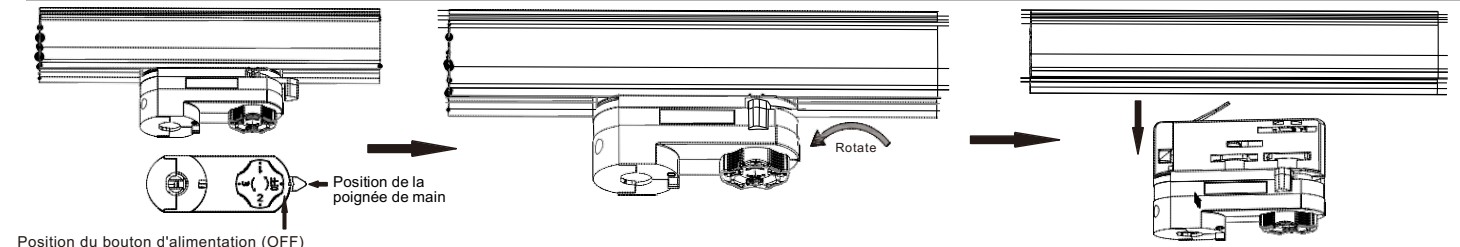

- Assurez-vous que la position de l'adaptateur de voie est identique à celle indiquée sur la photo avant de le retirer.
- Lorsque le bouton d'alimentation est en position "OFF", tournez la poignée à 90 degrés.
- Retirez l'adaptateur de voie.

Dluhopisy

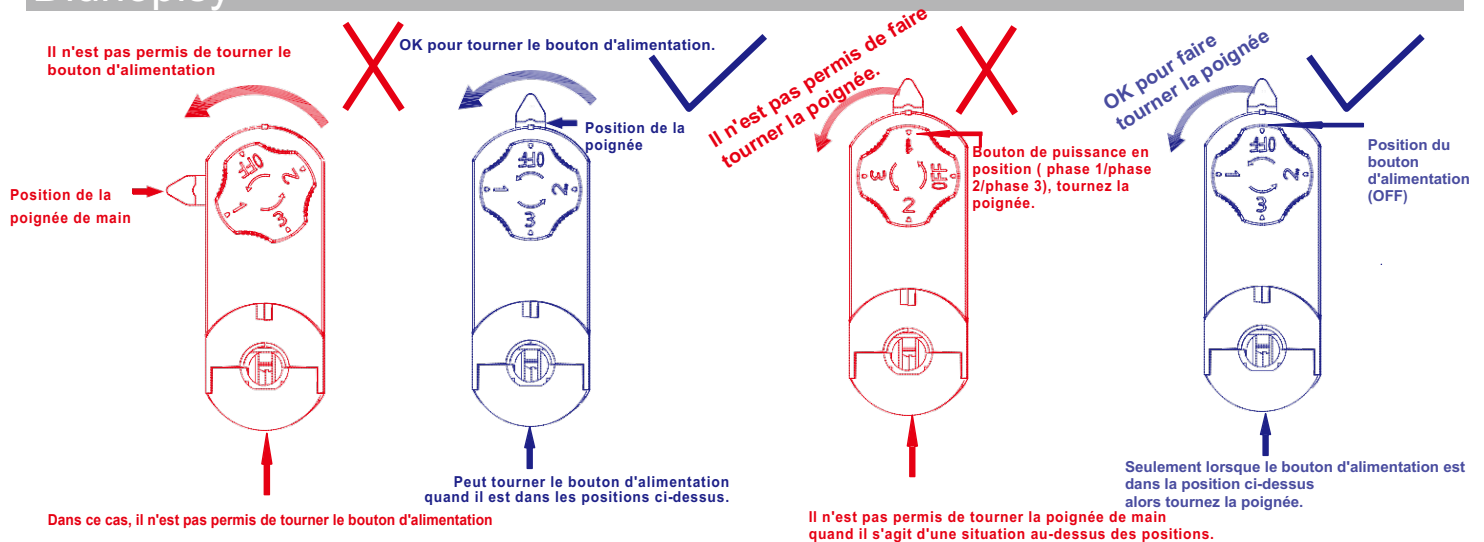

(Avant l'installation)

(Avant de retirer)