

10012736

1x E27 LED max. 15W
230V ~ 50Hz

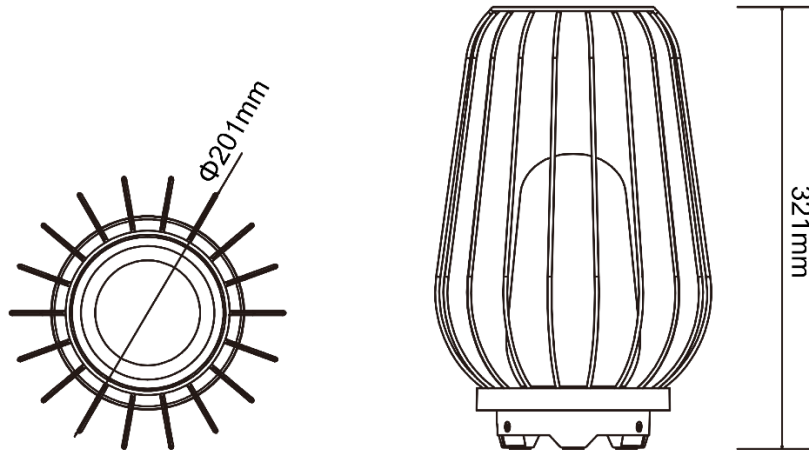

(DE) Bestimmungsgemäße Verwendung

(GB) Intended use / (FR) Utilisation conforme / (NL) Beoogd gebruik / (PL) Stosowanie zgodnie z przeznaczeniem /
(NO) Riktig bruk / (DK) Korrekt brug / (SE) Avsedd användning / (FI) Määräystenmukainen käyttö /
(IT) Impiego appropriato / (ES) Uso prescrito / (CZ) Použití v souladu s určením / (PT) Utilização correta / (GR) Ενδεικτική χρήση

| | | | |
|------|---|------|---|
| (DE) | Als Stehleuchte im Außenbereich | (GB) | Use as a floor lamp outdoors |
| (FR) | En tant que lampadaire sur des sols plats, stables, à l'extérieur | (NL) | Buitenshuis als staande lamp op effen ondergrond |
| (PL) | Jako lampa stojąca na równych, stabilnych podłogach na zewnątrz | (NO) | Som gulvlampe på rett flate utendørs |
| (DK) | Som gulvlampe på ret gulv udendørs | (SE) | Används som golvlampa utomhus |
| (FI) | Käyttö ulkotilojen lattiavalaisimena | (IT) | Impiego come lampada da pavimento in ambienti esterni |
| (ES) | Empleo en tanto lámpara de pie para exterior | (CZ) | Použití jako stojací lampa v exteriéru |
| (PT) | Aplicação como candeeiro de pé no exterior | (GR) | Χρήση ως επιδαπέδιο φωτιστικό σε εξωτερικό χώρο |

(DE) Verwendete Symbole

(GB) Safety Precautions / (FR) Symboles utilisés / (NL) Gebruikte symbolen / (PL) Stosowane symbole / (NO) Brukte symboler /
(DK) Brugte symboler / (SE) Använda symboler / (FI) Käytetyt symbolit / (IT) Simboli usati / (ES) Símbolos empleados /
(CZ) Použité symboly / (PT) Símbolos utilizados / (GR) Χρησιμοποιούμενα σύμβολα



(DE) Lieferumfang

(GB) Package contents / (FR) Contenu de la livraison / (NL) Bij de levering inbegrepen / (PL) Zakres dostawy / (NO) Levering /
(DK) Leveringsomfang / (SE) Leveransomfattning / (FI) Toimitussisältö / (IT) Fornitura / (ES) Volumen de suministro /
(CZ) Rozsah dodávky / (PT) Material fornecido / (GR) Παραδοτέος εξοπλισμός

| | | | | | |
|------|---|------|--|------|--|
| (DE) | 1 Stehleuchte Montagematerial Montageanleitung | (GB) | 1 Floor lamp Installation hardware Mounting instructions | (FR) | 1 Lampadaire Matériel de montage Instructions de montage |
| (NL) | 1 Vloerlamp Monteringsmateriale Montagehandleiding | (PL) | 1 Lampa stojąca Elementy montażowe Instrukcja montażu | (NO) | 1 Gulvlampe Monteringsmateriale Brukerveiledning |
| (DK) | 1 Gulvlampe Monteringsmateriale Brugervejledning | (SE) | 1 Golvlampa Monteringsmaterial Monteringsanvisning | (FI) | 1 Lattiavalaisin Asennus materiaali Asennusohjeet |
| (IT) | 1 Lampada da pavimento Materiale di montaggio Istruzioni di montaggio | (ES) | 1 Lámpara de pie Material de montaje Instrucciones de montaje | (CZ) | 1 Stojací lampa Materiál pro montáž Návod k montáži |
| (PT) | 1 Candeeiro de pé Material de montagem Instruções de montagem | (GR) | 1 Επιδαπέδιο φωτιστικό Υλικό συναρμολόγησης Οδηγίες συναρμολόγησης | | |



OUTDOOR

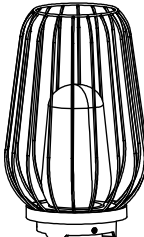

You will need

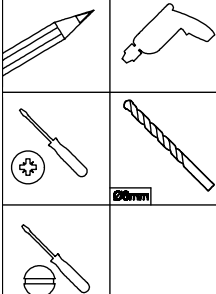

01

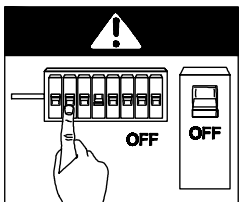

02

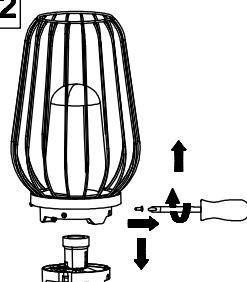

03

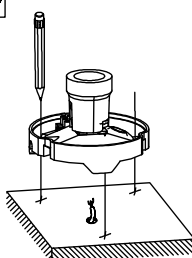

04

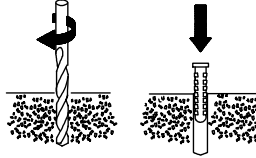

05

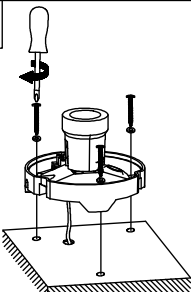

06

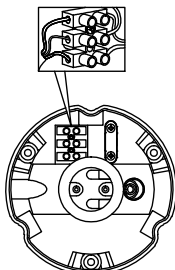

07

L= Brown or Red
N= Blue
⊕=Green/Yellow

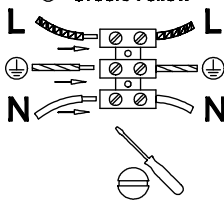

08

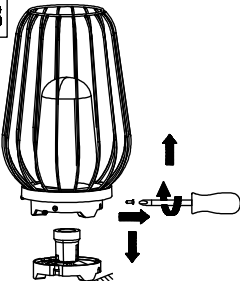

09



10



11



12

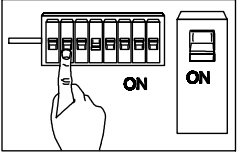

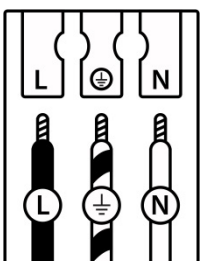

| | (DE) | (GB) | (FR) | (NL) | (PL) | (NO) | (DK) |
|----------|-----------------------|-------------------|----------------------------------|------------------------|---------------------|--------------------|--------------------|
| L | Stromführender Leiter | Live conductor | Conducteur | Spanningvoerende draad | Przewód prądowy | Strømførende leder | Strømførende leder |
| ⊕ | Schutzleiter | Earth conductor | Conducteur de protection (terre) | Aardkabel | Przewód uziemiający | Jordledningen | Jordledningen |
| N | Neutralleiter | Neutral conductor | Conducteur neutre | Nulleider | Przewód zerowy | Nøytralleder | Neutralleider |

| | (SE) | (FI) | (IT) | (ES) | (CZ) | (PT) | (GR) |
|----------|---------------------|-------------|---------------------------|-------------------------|-------------------|-------------------|---------------------|
| L | Strömförande ledare | Virtajohdin | Conduttore sotto tensione | Conductor de corriente | Vodič pod napětím | Condutor vivo | Ρευματοφόρος αγωγός |
| ⊕ | Skyddsledare | Suojajohdin | Conduttore di terra | Conductor de protección | Ochranný vodič | Condutor de terra | Αγωγός γείωσης |
| N | Neutralledare | Nollajohdin | Conduttore neutro | Conductor neutro | Neutrální vodič | Condutor neutro | Ουδέτερος αγωγός |