

# GRETA

GABRIEL  
TEIXIDÓ  
2016



# GRETA

GABRIEL  
TEIXIDÓ  
2016



# GRETA



**CARPYEN**  
BARCELONA SINCE 1948

Carpyellum70 S.L.  
C/ Pere IV 78-84 E-08005 Barcelona  
T +34 93 320 99 90

Spain: [comercial@carpyen.com](mailto:comercial@carpyen.com)  
Export: [export@carpyen.com](mailto:export@carpyen.com)  
Special project: [antony@carpyen.com](mailto:antony@carpyen.com)

# GRETA



**CARPYEN**  
BARCELONA SINCE 1948

Carpyellum70 S.L.  
C/ Pere IV 78-84 E-08005 Barcelona  
T +34 93 320 99 90

Spain: [comercial@carpyen.com](mailto:comercial@carpyen.com)  
Export: [export@carpyen.com](mailto:export@carpyen.com)  
Special project: [antony@carpyen.com](mailto:antony@carpyen.com)

# GRETA



**CARPYEN**  
BARCELONA SINCE 1948

Carpyellum70 S.L.  
C/ Pere IV 78-84 E-08005 Barcelona  
T +34 93 320 99 90

Spain: [comercial@carpyen.com](mailto:comercial@carpyen.com)  
Export: [export@carpyen.com](mailto:export@carpyen.com)  
Special project: [antony@carpyen.com](mailto:antony@carpyen.com)

# GRETA

Materiales / Materials  
Matériaux / Matters

Acabados / Finishes  
Finitions / Ausführung

Pantallas / Shades  
Abat-jours / Schirm

Estructura madera de roble con pantalla fibra natural o tela / Oak wood structure with natural fiber o fabric shade / Structure chêne avec abat jour en tissu ou de fibre naturelle / Eichenholz struktur mit Naturfasern

Asa: cuero / Handle: leather  
Poignéé: cuir / Henkel: leder



Roble natural  
Natural oak  
Chêne naturel  
Natürliche Eiche



Roble negro  
Black oak  
Chêne noir  
Schwarze Eiche



Fibra natural  
Natural fiber  
Fibre naturelle  
Naturfasern



Blanco  
White  
Blanc  
Weiss

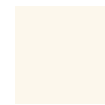

Lino: beige  
Linen: beige  
Lin: beige  
Leinen: beige

LED

Medidas / Measures  
Measurements / Mittengun

E-27 LED

Ø 40 cm / 15.7"

Equipado con interruptor  
Equipped with switch  
Equipé d'un interrupteur  
Mit Schalter

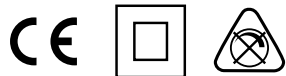
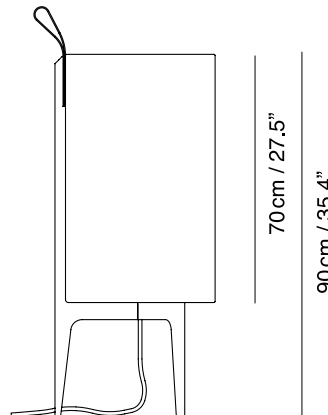
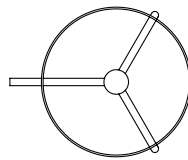

**CARPYEN**  
BARCELONA SINCE 1948

Carpyellum70 S.L.  
C/ Pere IV 78-84 E-08005 Barcelona  
T +34 93 320 99 90

Spain: comercial@carpyen.com  
Export: export@carpyen.com  
Special project: antony@carpyen.com

# GRETA

GABRIEL  
TEIXIDÓ  
2016



# GRETA



**CARPYEN**  
BARCELONA SINCE 1948

Carpyellum70 S.L.  
C/ Pere IV 78-84 E-08005 Barcelona  
T +34 93 320 99 90

Spain: [comercial@carpyen.com](mailto:comercial@carpyen.com)  
Export: [export@carpyen.com](mailto:export@carpyen.com)  
Special project: [antony@carpyen.com](mailto:antony@carpyen.com)



# GRETA



**CARPYEN**  
BARCELONA SINCE 1948

Carpylum70 S.L.  
C/ Pere IV 78-84 E-08005 Barcelona  
T +34 93 320 99 90

Spain: [comercial@carpyen.com](mailto:comercial@carpyen.com)  
Export: [export@carpyen.com](mailto:export@carpyen.com)  
Special project: [antony@carpyen.com](mailto:antony@carpyen.com)

# GRETA



**CARPYEN**  
BARCELONA SINCE 1948

Carpyellum70 S.L.  
C/ Pere IV 78-84 E-08005 Barcelona  
T +34 93 320 99 90

Spain: [comercial@carpyen.com](mailto:comercial@carpyen.com)  
Export: [export@carpyen.com](mailto:export@carpyen.com)  
Special project: [antony@carpyen.com](mailto:antony@carpyen.com)

# GRETA

Materiales / Materials  
Matériaux / Matters

Estructura madera de roble con pantalla fibra natural o tela / Oak wood structure with natural fiber o fabric shade / Structure chêne avec abat jour en tissu ou de fibre naturelle / Eichenholz struktur mit Naturfasern

Asa: cuero / Handle: leather  
Poignéé: cuir / Henkel: leder

Acabados / Finishes  
Finitions / Ausführung



Roble natural  
Natural oak  
Chêne naturel  
Natürliche Eiche

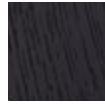

Roble negro  
Black oak  
Chêne noir  
Schwarze Eiche

Pantallas / Shades  
Abat-jours / Schirm



Fibra natural  
Natural fiber  
Fibre naturelle  
Naturfasern



Blanco  
White  
Blanc  
Weiss



Lino: beige  
Linen: beige  
Lin: beige  
Leinen: beige

LED

Medidas / Measures  
Measurements / Mittengun

E-27 LED

Equipado con interruptor  
Equipped with switch  
Equipé d'un interrupteur  
Mit Schalter

Ø 20 cm / 7.8"  
Ø 26 cm / 10.2"  
Ø 33 cm / 13"



Ø 20 cm / 7.8"

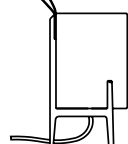
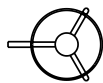

24 cm / 9.5"

33 cm / 13"

Ø 26 cm / 10.2"

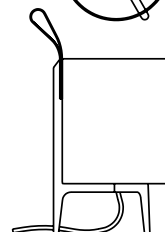
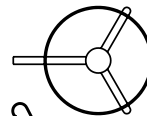

30 cm / 11.8"

44 cm / 17.3"

Ø 33 cm / 13"

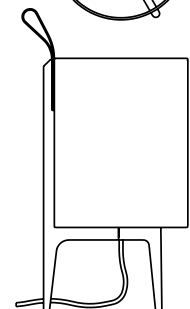
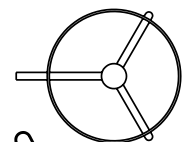

40 cm / 15.7"

58 cm / 22.8"

**CARPYEN**  
BARCELONA SINCE 1948

Carpyellum70 S.L.  
C/ Pere IV 78-84 E-08005 Barcelona  
T +34 93 320 99 90

Spain: comercial@carpyen.com  
Export: export@carpyen.com  
Special project: antony@carpyen.com

# GRETA\_BATTERY

GABRIEL  
TEIXIDÓ  
2019



# GRETA\_BATTERY



**CARPYEN**  
BARCELONA SINCE 1948

Carpylum70 S.L.  
C/ Pere IV 78-84 E-08005 Barcelona  
T +34 93 320 99 90

Spain: [comercial@carpyen.com](mailto:comercial@carpyen.com)  
Export: [export@carpyen.com](mailto:export@carpyen.com)  
Special project: [antony@carpyen.com](mailto:antony@carpyen.com)

# GRETA\_BATTERY

Materiales / Materials  
Matériaux / Matters

Estructura madera de roble con pantalla fibra natural o tela / Oak wood structure with natural fiber o fabric shade / Structure chêne avec abat jour en tissu ou de fibre naturelle / Eichenholz struktur mit Naturfasern

Asa: cuero / Handle: leather  
Poignéé: cuir / Henkel: leder

Acabados / Finishes  
Finitions / Ausführung



Roble natural  
Natural oak  
Chêne naturel  
Natürliche Eiche

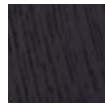

Roble negro  
Black oak  
Chêne noir  
Schwarze Eiche

Pantallas / Shades  
Abat-jours / Schirm



Fibra natural  
Natural fiber  
Fibre naturelle  
Naturfasern



Blanco  
White  
Blanc  
Weiss

LED integrado

3,7 W 500 Lumen 3000 K

Dimerizable / Dimming  
Dimmable / Dimbar  
Interruptor dimable  
Swicht dimm / Interrupteur dimmable / Dimmbare schalter

Mando a distancia incluido  
Remote control included  
Télécommande incluse  
Fernbedienung inklusive

Alimentación / Feeding  
Alimentation / Ladung

Funcionamiento por batería.  
Recarga con usb+cargador  
Battery operation. Recharging by usb + charger / Fonctionne avec batterie. Recharge avec usb + chargeur / Funktionert mit Batterie. Lädt über usb (Kabel)

Batería: autonomía de 8 h aprox. / Battery : autonomy of 8 h approx. / Batterie : autonomie 8 h environ  
Batterie : ungefähr 8 std.  
Autonomie

Medidas / Measures  
Measurements / Mittengun

Ø 16 cm / 6.2"  
Ø 20 cm / 7.8"

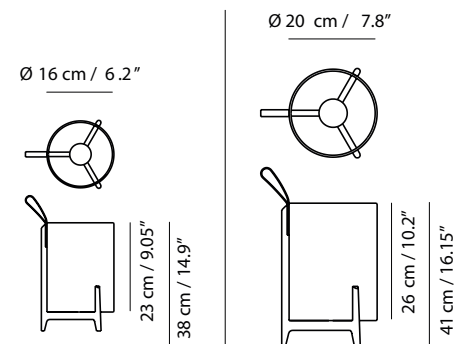

RECHARGABLE  
BATTERY

**CARPYEN**  
BARCELONA SINCE 1948

Carpyellum70 S.L.  
C/ Pere IV 78-84 E-08005 Barcelona  
T +34 93 320 99 90

Spain: comercial@carpyen.com  
Export: export@carpyen.com  
Special project: antony@carpyen.com

# GRETA

GABRIEL  
TEIXIDÓ  
2019



# GRETA



**CARPYEN**  
BARCELONA SINCE 1948

Carpylum70 S.L.  
C/ Pere IV 78-84 E-08005 Barcelona  
T +34 93 320 99 90

Spain: [comercial@carpyen.com](mailto:comercial@carpyen.com)  
Export: [export@carpyen.com](mailto:export@carpyen.com)  
Special project: [antony@carpyen.com](mailto:antony@carpyen.com)



# GRETA

Materiales / Materials  
Matériaux / Matters

Acabados / Finishes  
Finitions / Ausführung

Pantallas / Shades  
Abat-jours / Schirm

Estructura madera de roble con pantalla fibra natural o tela / Oak wood structure with natural fiber o fabric shade / Structure chêne avec abat jour en tissu ou de fibre naturelle / Eichenholz struktur mit Naturfasern

Asa: cuero / Handle: leather  
Poignéé: cuir / Henkel: leder



Roble natural  
Natural oak  
Chêne naturel  
Natürliche Eiche

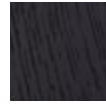

Roble negro  
Black oak  
Chêne noir  
Schwarze Eiche



Fibra natural  
Natural fiber  
Fibre naturelle  
Naturfasern



Blanco  
White  
Blanc  
Weiss

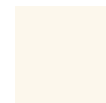

Lino: beige  
Linen: beige  
Lin: beige  
Leinen: beige

LED

Medidas / Measures  
Measurements / Mittengun

E-27 LED

Ø 18 cm / 7.08"

Ø 18 cm / 7.08"

6 cm / 2.3"

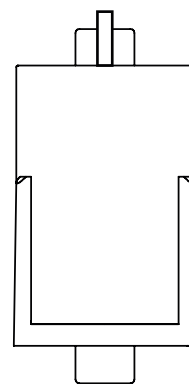

26 cm / 10.2"

36 cm / 14.17"

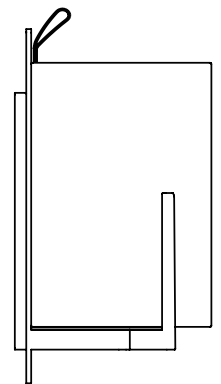

**CARPYEN**  
BARCELONA SINCE 1948

Carpyellum70 S.L.  
C/ Pere IV 78-84 E-08005 Barcelona  
T +34 93 320 99 90

Spain: comercial@carpyen.com  
Export: export@carpyen.com  
Special project: antony@carpyen.com