

# Technisches Datenblatt / Technical Datasheet

## Art.-No. 82307

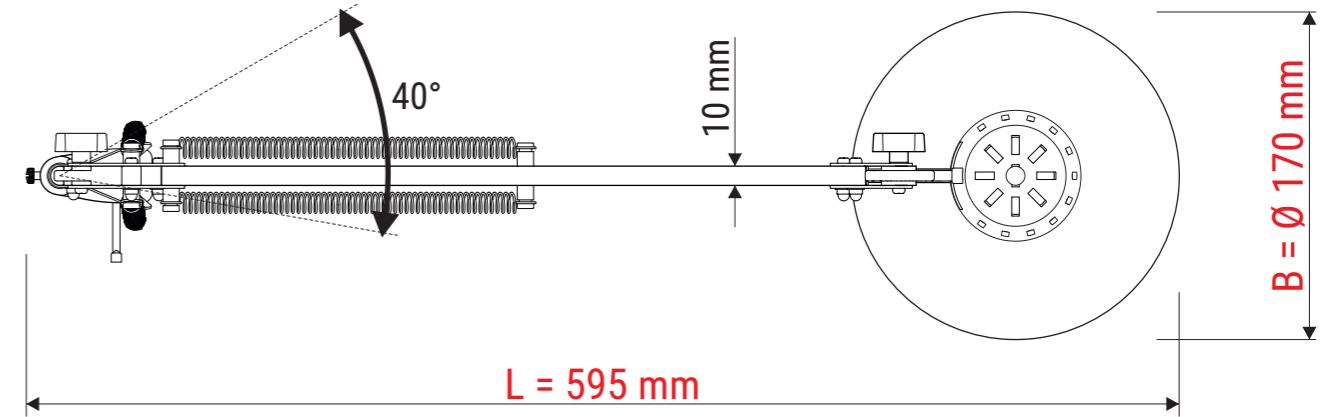
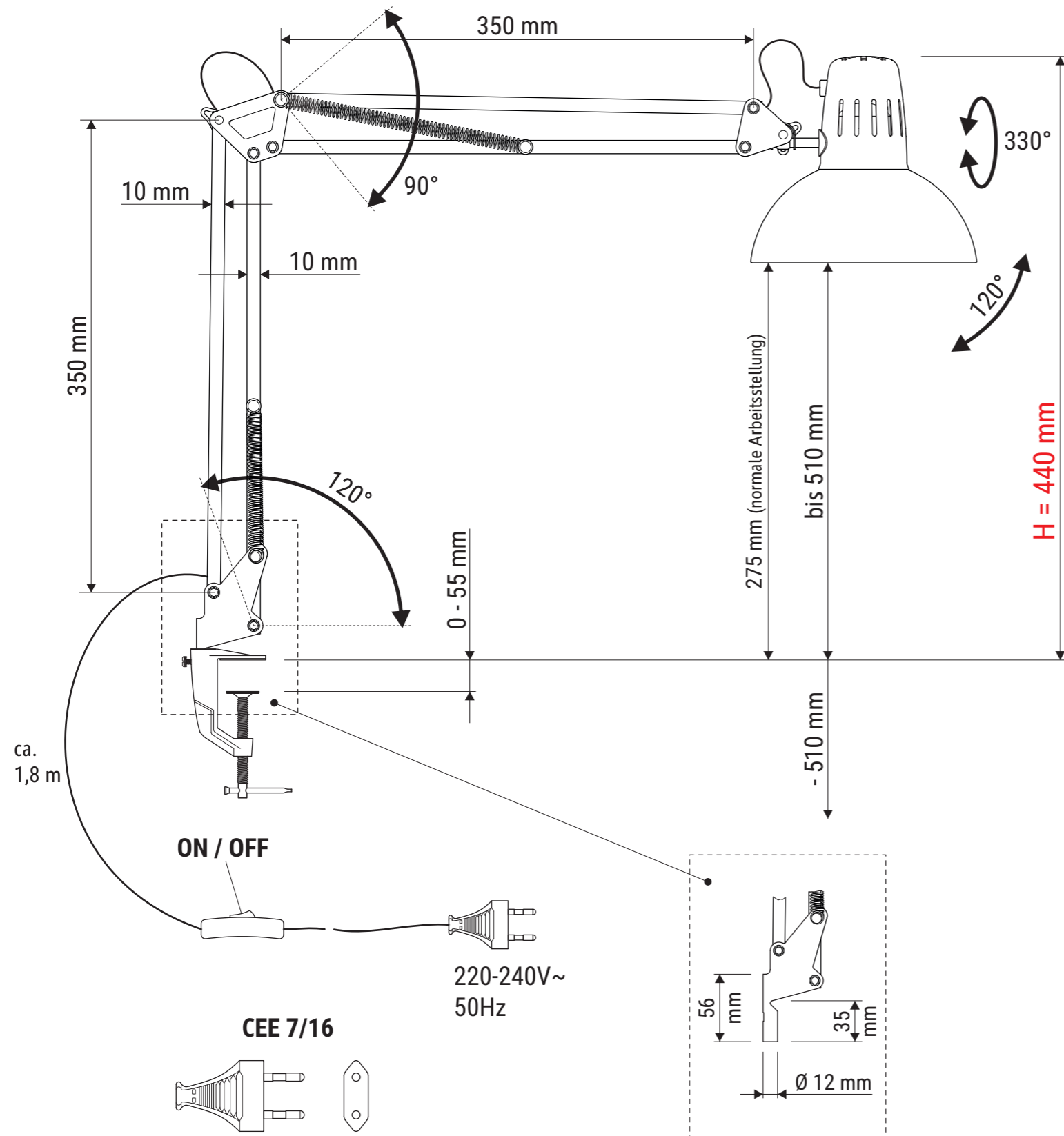

Abmaße Produkt: **L x B x H**  
 595 x 170 x 440 mm (Arme senkrecht + waagrecht 90° zueinander)  
 Gewicht: 0,810 kg

Verp. Abmaße : L x B x H  
 450 x 260 x 95 mm  
 Gewicht kompl.: 1,113 kg