

10020424

1x E27 LED max. 15W
230V ~ 50Hz

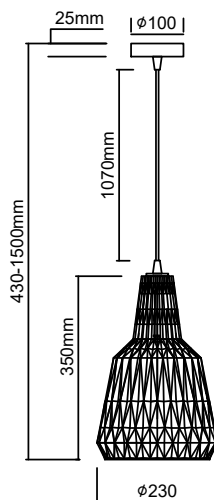

(DE) Bestimmungsgemäße Verwendung

(GB) Intended use / (FR) Utilisation conforme / (NL) Beoogd gebruik / (PL) Stosowanie zgodnie z przeznaczeniem / (NO) Riktig bruk / (DK) Korrekt brug / (SE) Avsedd användning / (FI) Määräystenmukainen käyttö / (IT) Impiego appropriato / (ES) Uso prescrito / (CZ) Použití v souladu s určením / (PT) Utilização correta / (GR) Ενδεδειγμένη χρήση

(DE)	Ortsfeste Verwendung als Hängeleuchte im Innenbereich	(GB)	Provided for stationary indoor use as pendant light
(FR)	Utilisation stationnaire en tant que suspension d'intérieur	(NL)	Vast gebruik als hanglamp binnenshuis
(PL)	Do montażu stacjonarnego jako lampa wisząca do wewnątrz	(NO)	Til stasjonært bruk som pendellampe innendørs
(DK)	Til stationær brug som pendellampe indendørs	(SE)	Används som fast hänglampa inomhus
(FI)	Kiinteä käyttö sisätilojen riippuvaisimena	(IT)	Impiego fisso come lampada a sospensione in ambienti interni
(ES)	Empleo fijo en tanto lámpara colgante en interiores	(CZ)	Stacionární použití jako závěsné svítidlo v interiéru
(PT)	Aplicação fixa como candeeiro suspenso em interiores	(GR)	Σταθερή χρήση ως κρεμαστό φωτιστικό σε εσωτερικό χώρο

(DE) Verwendete Symbole

(GB) Safety Precautions / (FR) Symboles utilisés / (NL) Gebruikte symbolen / (PL) Stosowane symbole / (NO) Brukte symboler / (DK) Brugte symboler / (SE) Använda symboler / (FI) Käytetyt symbolit / (IT) Simboli usati / (ES) Símbolos empleados / (CZ) Použité symboly / (PT) Símbolos utilizados / (GR) Χρησιμοποιούμενα σύμβολα

IP 20



(DE) Lieferumfang

(GB) Package contents / (FR) Contenu de la livraison / (NL) Bij de levering inbegrepen / (PL) Zakres dostawy / (NO) Levering / (DK) Leveringsomfang / (SE) Leveransomfattning / (FI) Toimitussisältö / (IT) Fornitura / (ES) Volumen de suministro / (CZ) Rozsah dodávky / (PT) Material fornecido / (GR) Παραδοτέος εξοπλισμός

(DE)	1 Hängeleuchte Montagematerial Montageanleitung	(GB)	1 Pendant light Installation hardware Mounting instructions	(FR)	1 Suspension Matériel de montage Instructions de montage
(NL)	1 Hanglamp Monteringsmateriale Montagehandleiding	(PL)	1 Lampa wisząca Elementy montażowe Instrukcja montażu	(NO)	1 Pendellampe Monteringsmateriale Brukerveiledning
(DK)	1 Pendellampe Monteringsmateriale Brugervejledning	(SE)	1 Hänglampa Monteringsmaterial Monteringsanvisning	(FI)	1 Riippuvaisin Asennus materiaali Asennusohjeet
(IT)	1 Lampada a sospensione Materiale di montaggio Istruzioni di montaggio	(ES)	1 Lámpara colgante Material de montaje Instrucciones de montaje	(CZ)	1 Závěsné svítidlo Materiál pro montáž Návod k montáži
(PT)	1 Candeeiro suspenso Material de montagem Instruções de montagem	(GR)	1 Κρεμαστό φωτιστικό Υλικά συναρμολόγησης Οδηγίες συναρμολόγησης		

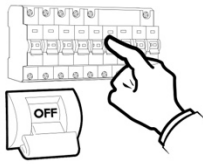

1

2

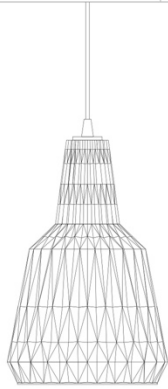
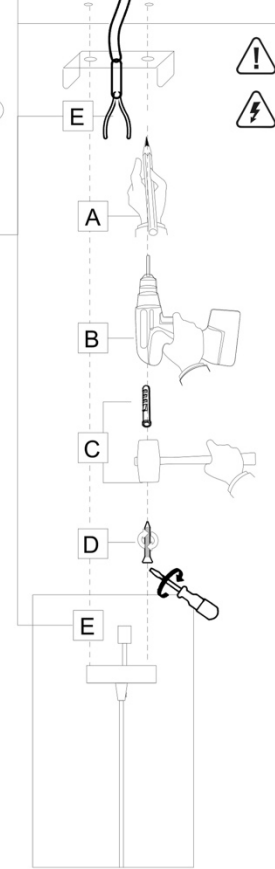
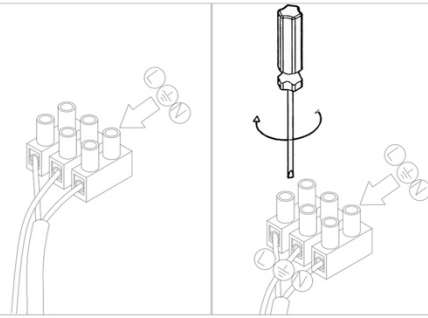

3

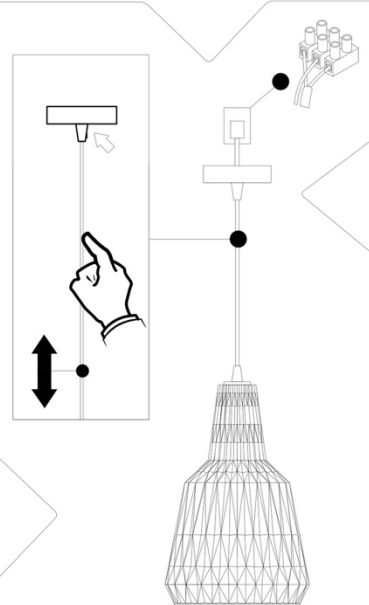

i

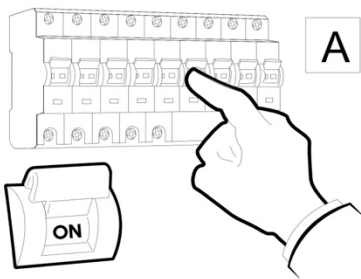

4

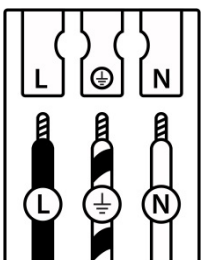
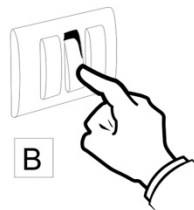

	(DE)	(GB)	(FR)	(NL)	(PL)	(NO)	(DK)
L	Stromführender Leiter	Live conductor	Conducteur	Spanningvoerende draad	Przewód prądowy	Strømførende leder	Strømførende leder
⊕	Schutzleiter	Earth conductor	Conducteur de protection (terre)	Aardkabel	Przewód uziemiający	Jordledningen	Jordledningen
N	Neutralleiter	Neutral conductor	Conducteur neutre	Nulleider	Przewód zerowy	Nøytralleder	Neutralleder

	(SE)	(FI)	(IT)	(ES)	(CZ)	(PT)	(GR)
L	Strömförande ledare	Virtajohdin	Conduttore sotto tensione	Conductor de corriente	Vodič pod napětím	Condutor vivo	Ρευματοφόρος αγωγός
⊕	Skyddsledare	Suojajohdin	Conduttore di terra	Conductor de protección	Ochranný vodič	Condutor de terra	Αγωγός γείωσης
N	Neutralledare	Nollajohdin	Conduttore neutro	Conductor neutro	Neutrální vodič	Condutor neutro	Ουδέτερος αγωγός