

GEJST

HARDWIRED WALL LAMP RADENT

By Rune Krøjgaard

Instruction

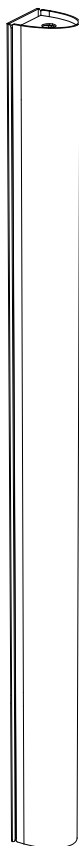

ATTENTION

In some countries, electrical installation must be carried out by authorised electricians/contractors; please check with your local authority for guidance.

The product must not be modified in any way.

Gejst accepts no responsibility for any products that have been modified or tampered with.

This lamp is designed for indoor use only.

The RADENT wall lamps are designed to be used with LED direct driver (one circuit) based light sources only. Halogen or incandescent light sources should never be used, as it may cause damage to the lamp. Gejst accepts no responsibility for any damage due to the use of incorrect light sources.

TECHNICAL DATA

This product is fitted with a LED tube warm white LED Tube, 3000 Kelvin.

Average lifespan 35,000 Hours.

The lamps are only fitted with single output LED tubes. Direct Driver which only provide electricity in one end.

Please NOTE to place the electrical end towards the cable.

Gejst will not accept any responsibility for any accidents or injuries that occur due to the use of incorrect bulbs.

Content of the box



A x1



B x1



C x1



D x2



E x2



F x2

- ① Please make sure to turn the power supply off before assembling your RADENT lamp.

Measure and mark where the holes need to be placed.

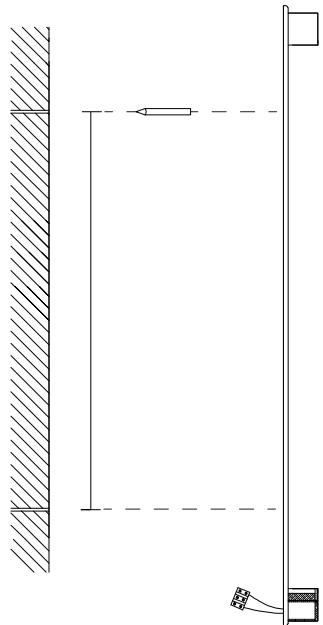

GEJST

- ② Drill the holes and insert the plugs (Part D).

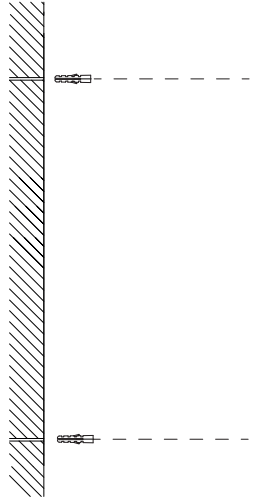

- ③ Connect the cables to the power supply.

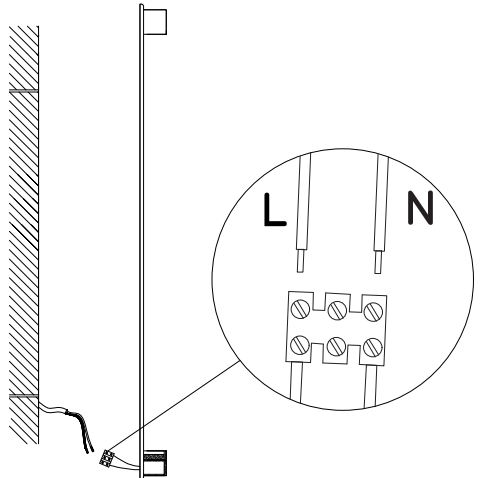

GEJST

- ④ Secure the base (Part A) to the wall with the screws (Part E)

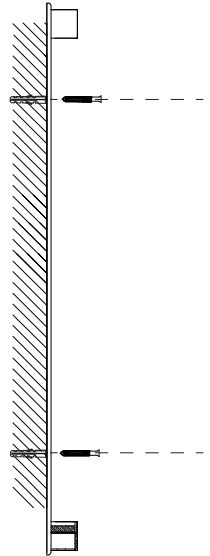

- ⑤ Insert the LED tube (Part B) into the base (Part A).

Please make sure to place the LED tube with the L and N towards the end of the lamp where the power is connected.

Fasten the LED tube by holding the lamp and turn the LED tube with your thumbs 90 degrees.

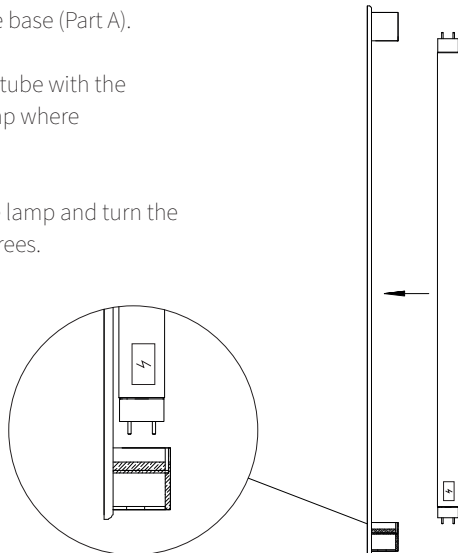

GEJST

- ⑥ Place the lampshade (Part C) over the LED tube (Part B) and base (Part A).

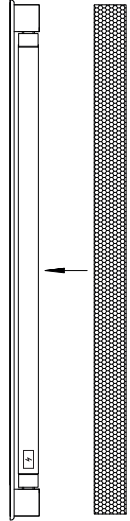

- ⑦ Tighten the bolts (Part E) to secure the lampshade (Part C).

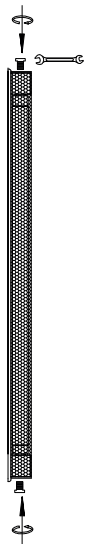

GEJST

- ⑧ RADENT hardwired wall lamp is now assembled.

