

Minuit

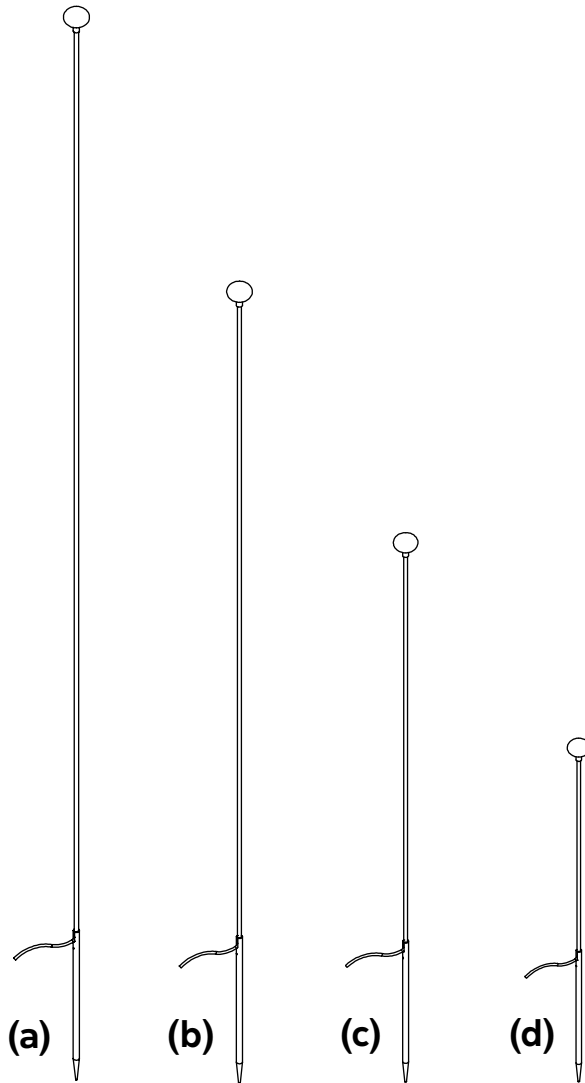

KARMAN

IT Se il cavo flessibile esterno di quest'apparecchio viene danneggiato, deve essere sostituito dal costruttore o dal servizio di assistenza o da personale qualificato equivalente al fine di evitare pericoli.

-Togliere tensione prima dell'installazione o di qualsiasi manutenzione.
-Il prodotto deve essere montato da personale qualificato, rispettando le norme impianti in vigore.



Attenzione! Apparecchio artistico, tenere lontano dalla portata dei bambini.



Attenzione! Rischio scossa elettrica. Togliere la tensione elettrica in assenza di lampadina.

EN If the flexi cord on the outside of this appliance becomes damaged, it must be replaced by the manufacturer or by its assistance service or a qualified service engineer, in order to avoid all hazard risks.

-Disconnect from the mains power before installing or carrying out any maintenance.
-This item must be fitted by a qualified person, compliant with current installation regulations.



Warning! Artistic appliance. Keep out of the reach of children.



Warning! Electric shock risk. Disconnect from the mains power if no light bulb is fitted.

FR Si le câble souple externe de cet appareil est endommagé, il doit être remplacé par le fabricant, par son service d'assistance ou par une personne qualifiée afin d'éviter tout danger.

-Couper l'alimentation avant l'installation ou toute opération d'entretien.
-Le produit doit être installé par un personnel qualifié, en respectant les règles d'installation en vigueur.



Attention ! Cet appareil n'est pas un jeu, tenir hors de la portée des enfants.



Attention ! Risque de choc électrique. Couper l'alimentation électrique en l'absence d'ampoule.

DE Wenn das äußere Kabel dieses Gerätes beschädigt wird, muss es durch den Hersteller, den Kundendienst oder ähnlich qualifizierte Personen ersetzt werden, um Gefahren zu vermeiden.

-Unterbrechen Sie die Stromversorgung vor der Installation oder Wartung.
-Das Produkt darf nur von qualifizierten Personen und unter Beachtung der geltenden Anlagenvorschriften installiert werden.



Achtung! Kein Spielzeug! Bitte von Kindern fernhalten.



Achtung! Stromschlaggefahr. Unterbrechen Sie die Stromversorgung, falls keine Glühbirne eingeschraubt ist.

ES Si el cable flexible externo de este aparato se daña debe ser sustituido por el fabricante o el servicio de asistencia o personal cualificado equivalente para evitar peligros.

-Quitar tensión antes de proceder con la instalación o cualquier trabajo de mantenimiento.
-El producto debe ser montado por personal cualificado de conformidad con las normas vigentes para instalaciones.



¡Atención! Aparato artístico, mantener alejado del alcance de los niños.



¡Atención! Riesgo de choque eléctrico. Desconectar la tensión eléctrica en ausencia de bombilla.

PT Se o cabo flexível externo deste aparelho for danificado, deve ser substituído pelo fabricante ou pelo serviço de assistência ou por pessoal qualificado equivalente, para evitar perigos.

-Desligue a tensão antes da instalação ou qualquer operação de manutenção.
-O produto deve ser montado por pessoal qualificado, respeitando as normas dos sistemas em vigor.



Atenção! Aparelho artístico, manter longe do alcance das crianças.



Atenção! Risco de choque elétrico. Desligar a tensão elétrica na ausência de lâmpada.

NL Om gevaar te vermijden moet de externe flexibele kabel van dit apparaat, indien beschadigd, door de fabrikant, zijn technische dienst of equivalent bevoegd personeel vervangen worden.

-Voor elke installatie of onderhoudswerkzaamheid de spanning afsluiten.
-Het product moet door bevoegd personeel gemonteerd worden met inachtneming van de geldende normen.



Aandacht! Art apparaatuur, uit de buurt van kinderen houden.



Aandacht! Gevaar voor elektrische schokken. Als geen lamp aanwezig is de stroom afsluiten.

SV Om apparatens sladd skadas ska den för att förhindra risker bytas ut av tillverkaren, kundservice eller likvärdig kvalificerad personal.

-Koppla alltid bort spänningen innan installation eller underhållsarbete.
-Produkten ska monteras av kvalificerad personal som ska följa gällande anläggningsföreskrifter.



Observera! Detta är ett konstföremål, inte en leksak, och ska förvaras utom räckhåll för barn.



Observera! Risk för elstöt. Koppla bort den elektriska spänningen när det saknas lamp.

NO Hvis den bøylige ytre ledningen ved dette apparatet skades, må den skiftes ut av produsenten eller servicetjenesten eller av tilsvarende kvalifisert fagfolk for å kunne unngå farer.

-Koble fra spenningen før installasjon eller ethvert vedlikeholdsinngrep.

-Produktet må være montert av kvalifisert fagfolk, mens de gjeldende lovforskriftene overholdes.



Advarsel! Kunstnerisk apparat, må holdes utenfor barns rekkevidde.



Advarsel! Fare for elektrisk støt. Koble fra den elektriske spenningen hvis lyspæren mangler.

FI Jos tämän laitteen ulkopuolinen johto vahingoittuu, vaaroen välttämiseksi se on annettava vaihdettavaksi valmistajalle tai huoltopalvelulle tai vastaavaan ammattitaitoon omaavalle henkilökunnalle.

-Poista jännite ennen asennusta tai ennen minkä tahansa huolto- tai korjauksen suorittamista.
-Tuote on asennettava ammattitaitoisin henkilökunnan toimesta voimassa olevia määräyksiä noudattaen.



Varoitus! Taidelaitte, pidä lasten ulottumattomissa.



Varoitus! Sähköiskuvaara. Poista sähköjännite, kun laitteessa ei ole lampua.

PL Jeżeli przewód giętki na zewnątrz urządzenia zostanie uszkodzony, ze względów bezpieczeństwa musi zostać wymieniony przez producenta, serwis techniczny lub osobę o równorzędnych kwalifikacjach.

-Przed przystąpieniem do instalacji lub jakiegokolwiek czynności konserwacyjnej odłącz napięcie.

-Produkt musi zostać zamontowany przez wykwalifikowany personel zgodnie z obowiązującymi przepisami dotyczącymi instalacji.



Uwaga! Wyrób artystyczny, przechowywać poza zasięgiem dzieci.



Uwaga! Niebezpieczeństwo porażenia prądem. W przypadku braku żarówki odłączyc od napięcia elektrycznego.

CS V případě poškození externího kabelu tohoto svítidla musíte zajistit jeho výměnu prostřednictvím výrobce, technického servisu nebo kvalifikovaného technika, aby nedošlo k žádným nebezpečným situacím.

-Před instalací a údržbou odpojte od přívodu elektrického proudu.

-Výrobek musí namontovat kvalifikovaný technik za dodržení platných předpisů.



Pozor! Umělecké svítidlo. Uchovávejte mimo dosah dětí.



Pozor! Nebezpečí zásahu elektrickým proudem. Po sejmutí žárovky odpojte svítidlo od přívodu elektrického proudu.

SK Ak sa poškodí externý flexibilný kábel tohto svietidla, výrobca alebo asistenčná služba alebo kvalifikovaný pracovník musí vykonať jeho výmenu za rovnaký, aby sa predišlo rizikám.

-Pred vykonaním inštalácie alebo akejkolvek údržby odpojte napätie.

-Výrobok musí namontovať kvalifikovaný pracovník s dodržaním, platných noriem.



Upozornenie! Melekké svietidlo, držte ho z dosahu detí.



Upozornenie! Riziko zasiahnutia elektrickým prúdom. Po sejmúti žiarovky, vypnite elektrický prúd.

SL Če se zunanjí prožni kabel naprave poškoduje, ga mora zamenjati proizvajalec ali serviser ali enakovredno usposobljeno osebe in tako preprečiti nevarnost.

-Pred namestitvijo ali kakršnim koli vzdrževanjem izklopite napajanje.

-Proizvod mora namestiti strokovno usposobljena oseba ob upoštevanju veljavnih predpisov za namestitvev.



Pozor! Umetniški izdelek hranite izven dosega otrok.



Pozor! Nevarnost električnega udara. Izključite napajanje, če žarnica ni vstavljena.

BG Ако външният гъвкав кабел на това осветително тяло бъде повреден, той трябва да се подмени от производителя, от центъра за обслужване на клиенти или от друг квалифициран персонал, за да се избегнат евентуални рискове.

-Изключете захранването преди да извършвате операции по монтаж или поддръжка.

-Продуктът трябва да се монтира от квалифициран персонал при спазване на съответните действащи правила и разпоредби.



Внимание! Декоративно осветително тяло. Да се пази далече от достъп на деца.



Внимание! Риск от токов удар. Изключете захранването при липса на електрическа крушка.

RO În situația în care cablul flexibil exterior al acestui aparat este deteriorat, este necesar să fie înlocuit de producător sau de serviciul de asistență ori de personal calificat echivalent, pentru prevenirea unor accidente.

-Întrerupeți alimentarea cu tensiune mai înainte de instalare sau de orice operațiune de întreținere.

-Produsul trebuie să fie montat de personal calificat, conform standardelor în vigoare privind instalațiile.



Atenție! Aparat artistic, nu lăsați la îndemână copiilor.



Atenție! Risc de electrocutare. Întrerupeți alimentarea cu tensiune electrică în lipsa becului.

HR Ako se vanjski savitljivi kabel ovog uređaja ošteti, proizvođač ili servisna služba ili odgovarajuće osposobljeno osoblje moraju ga zamijeniti kako se ne biste izlagali mogućim opasnostima.

-Isključite napajanje prije postavljanja ili izvođenja bilo kojeg postupka održavanja.

-Postupak postavljanja treba obaviti osposobljeno osoblje i pritom se pridržavati važećih pripadajućih pravila.

C - 01

P

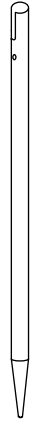

x1

V



x1

C

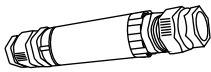

x1

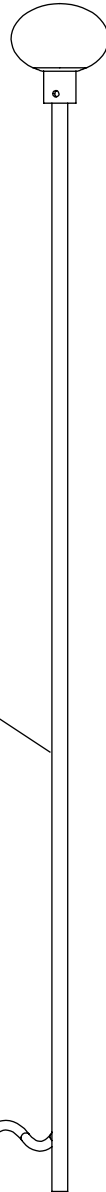

L

CO



AL

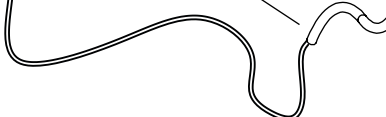

1

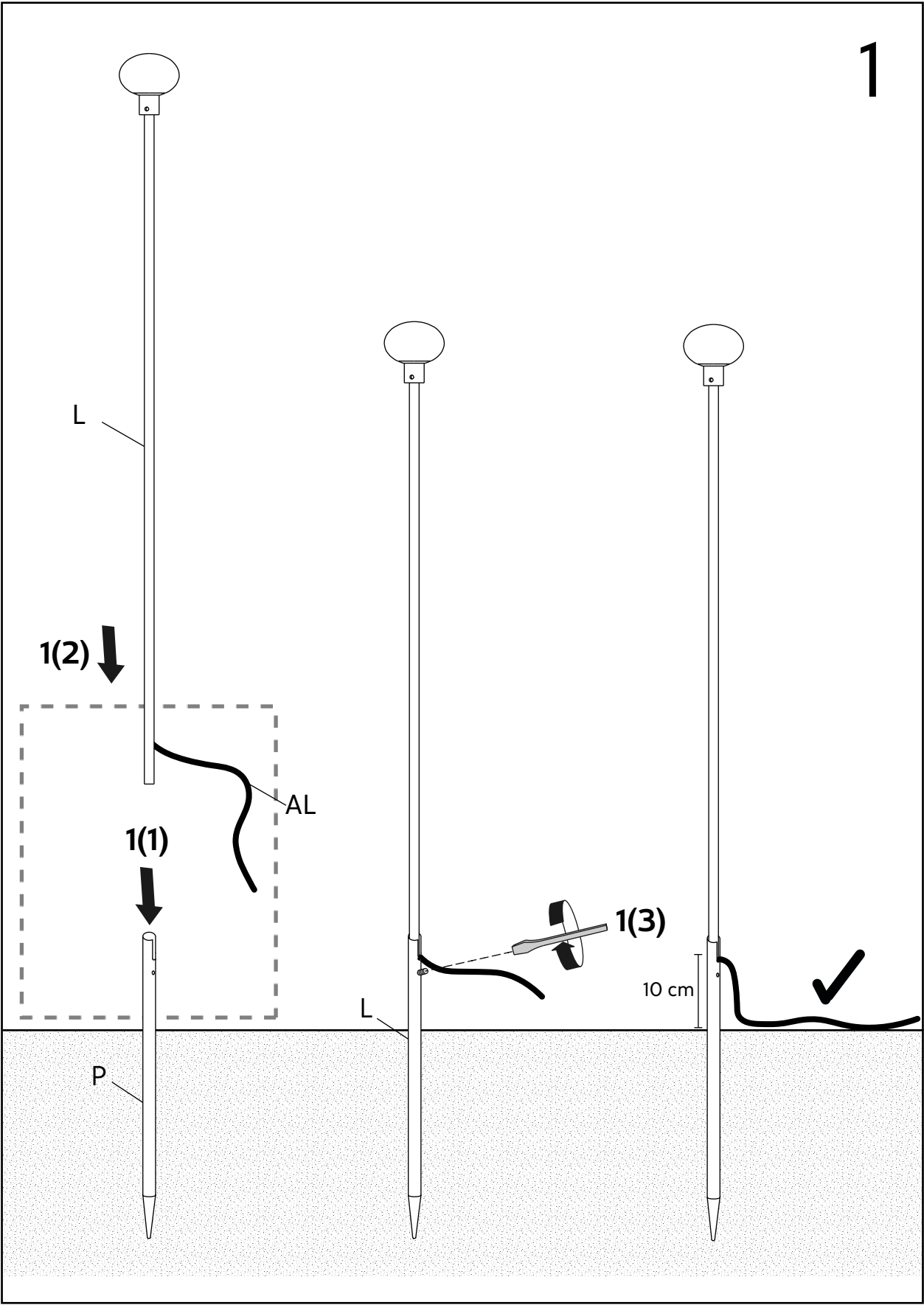

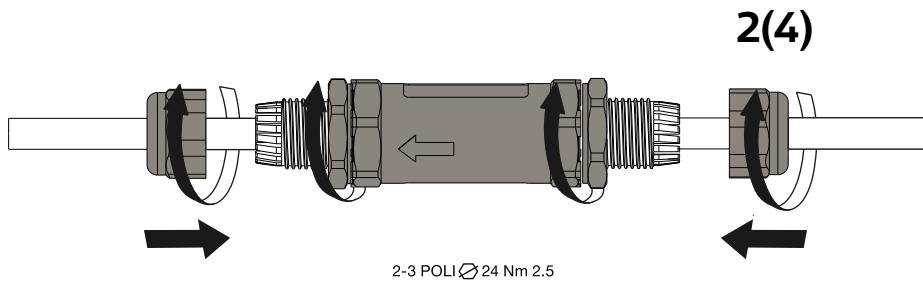
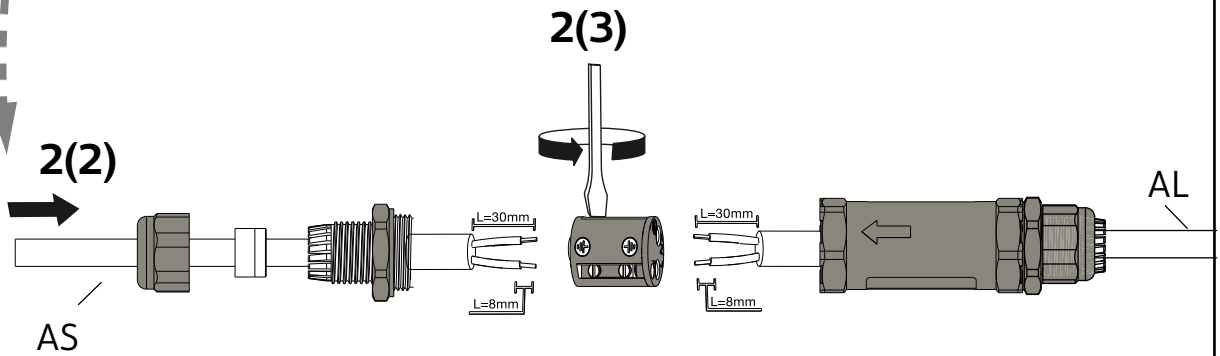
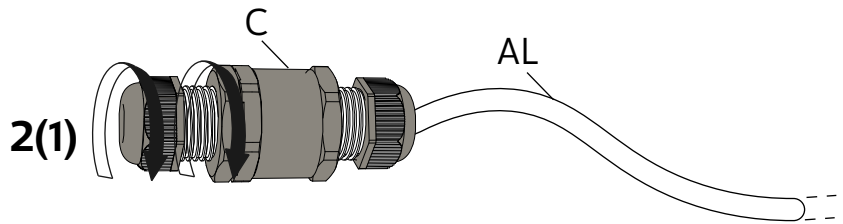
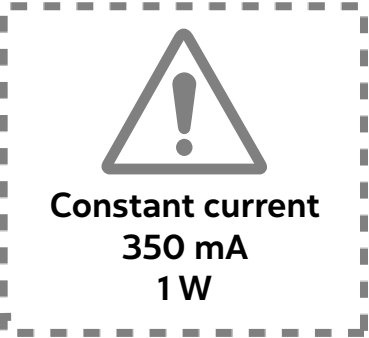
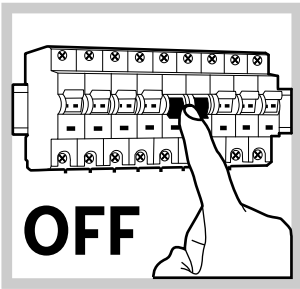

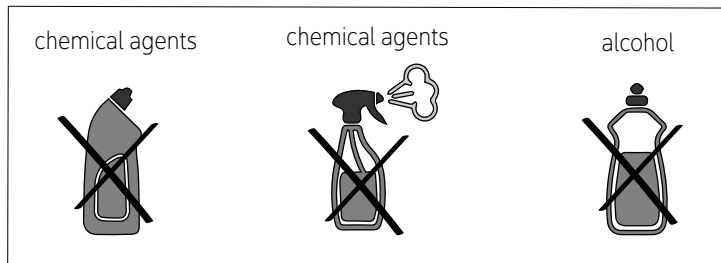
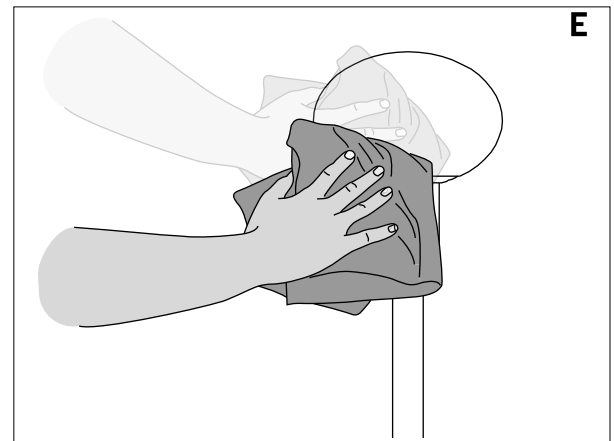
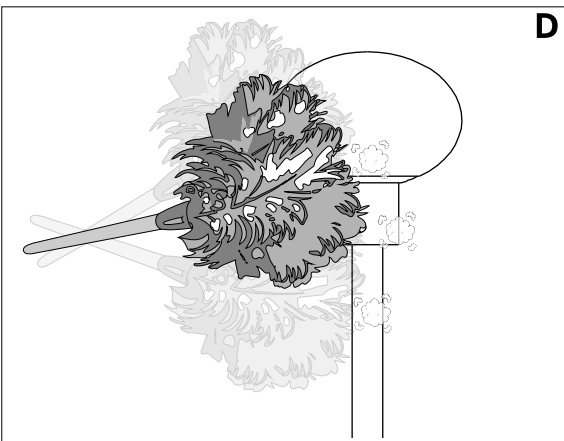
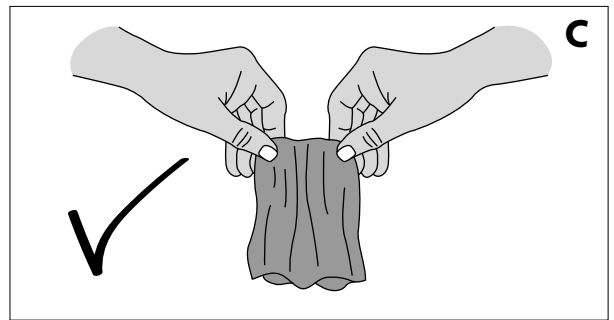
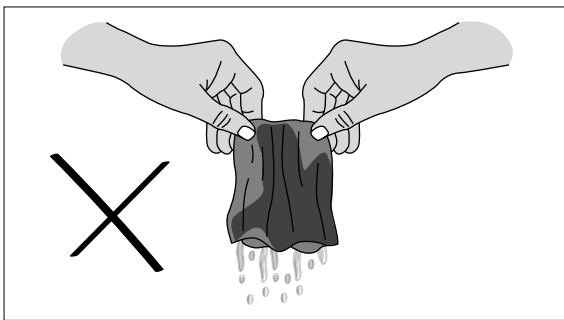
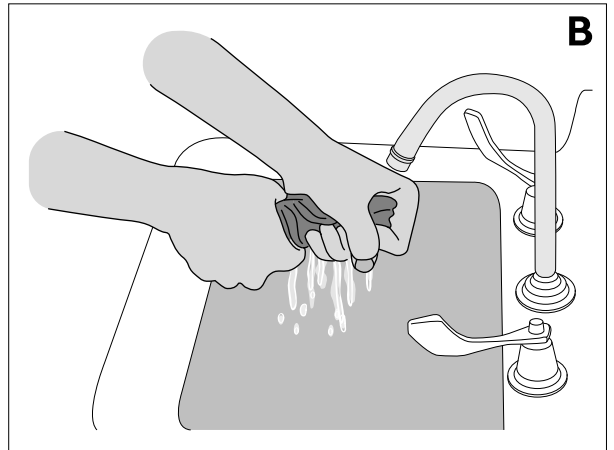
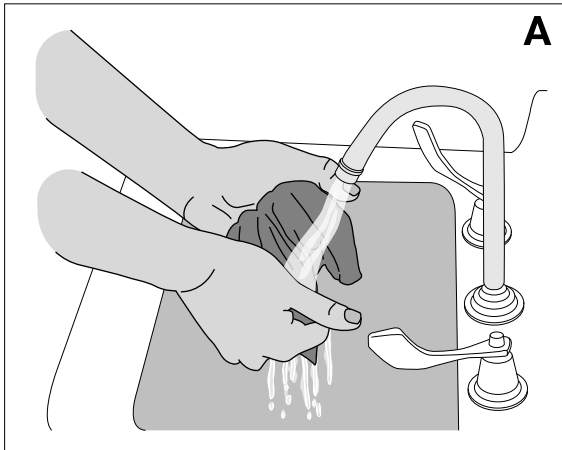

HP318ANEXT (a)
HP318BNEXT (b)
HP318CNEXT (c)
HP318DNEXT (d)

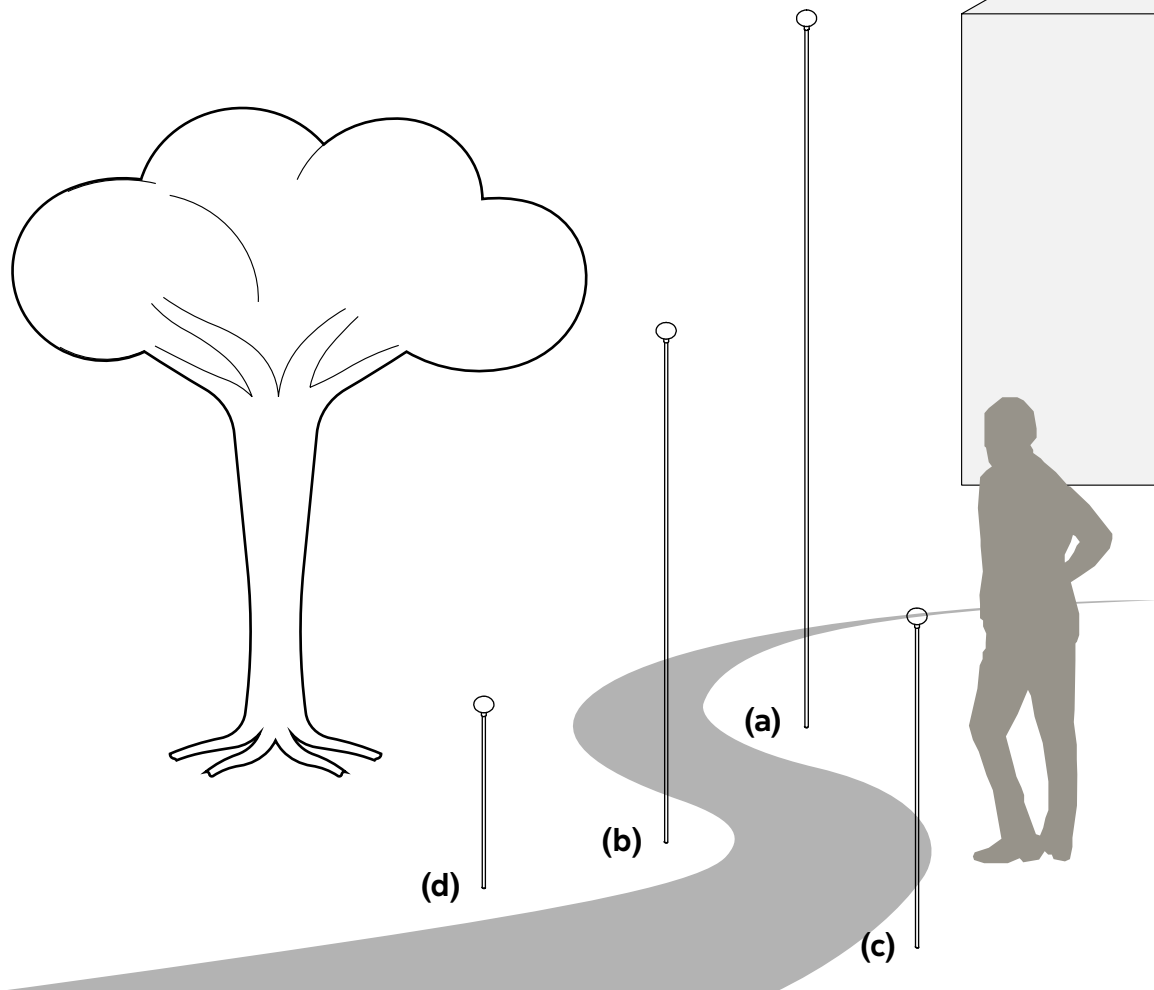
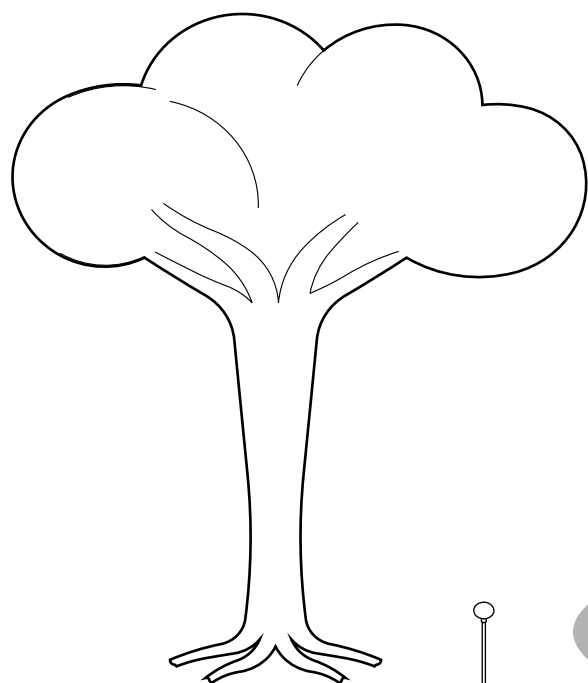

1W LED, 350 mA

IP65   CE

Karman srl

Via A. Grandi, San Martino del Piano, 61034 Fossombrone (PU), Italy - p.iva 02175640412 tel +39 0721715042 r.a fax +39 0721716640 - www.karmanitalia.it