

FAGERHULT

SE - 566 80 Habo

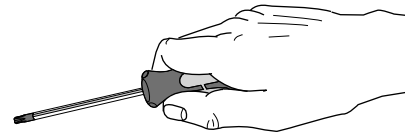

Allfive

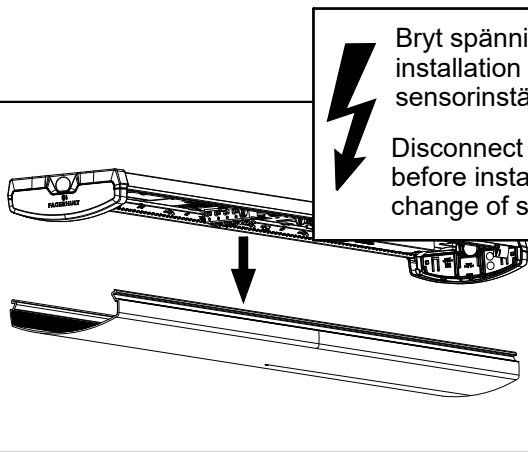
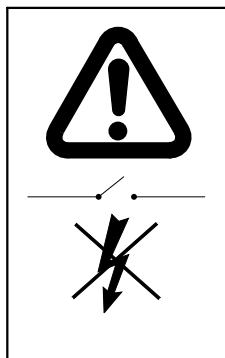

⚡ Bryt spänningen före installation och vid sensorinställningar
 Disconnect luminare before installation and change of sensor settings

(GB) For use in environments where no unusual accumulation of dust is expected.

(S) För användning i miljöer där ingen ovanlig ansamling av damm förväntas.



1

IP44/40

IP44

IP40

IP40

1200 alt.2

Sensor variants	
Organic Response	IP21/20
Brightswitch	IP41/40

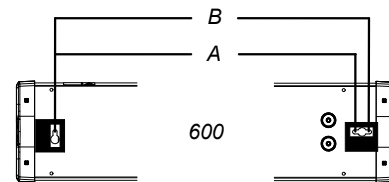

Size	A	B
600	520,5	539,5
1200	1048,5	1083,5
1500	1408,5	1427,5

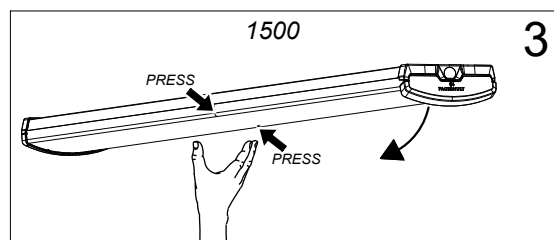
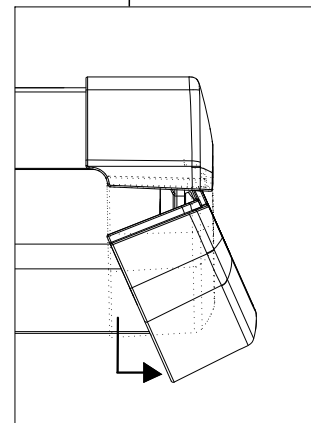
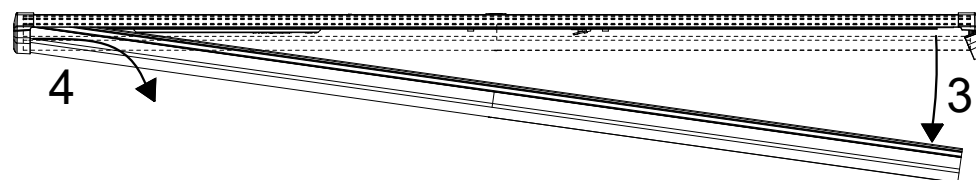
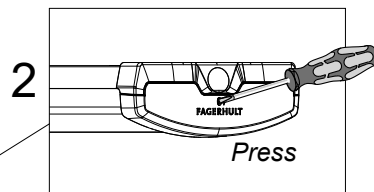
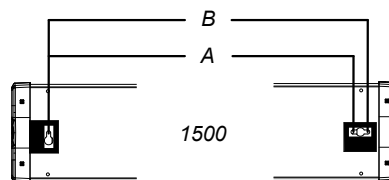
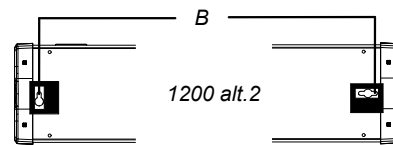
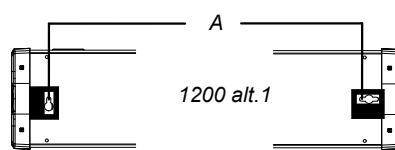

5

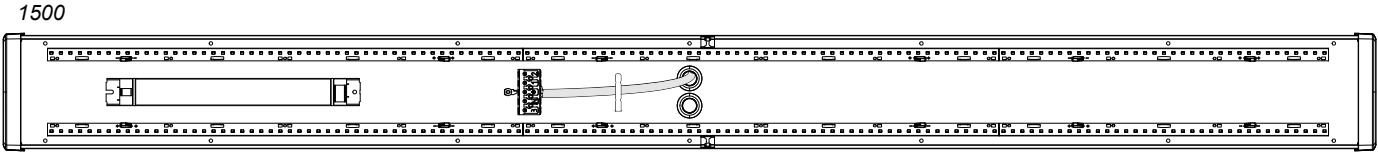
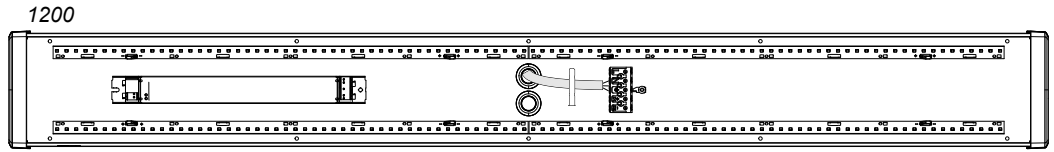
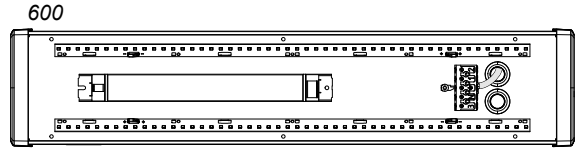

Through wiring

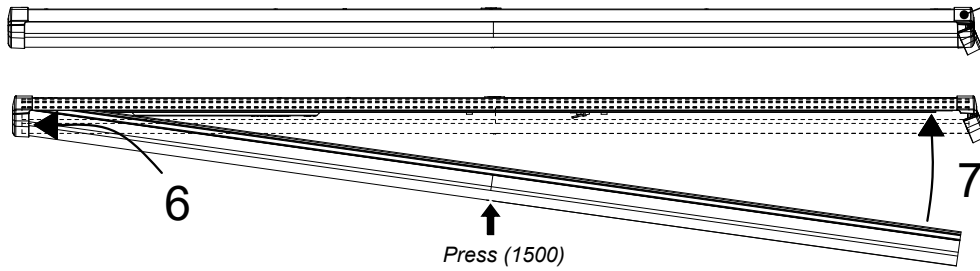
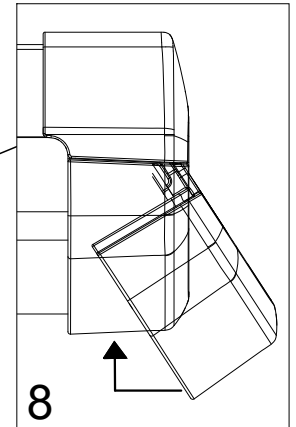
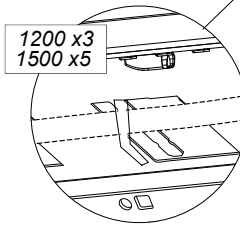
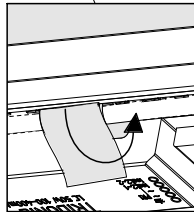
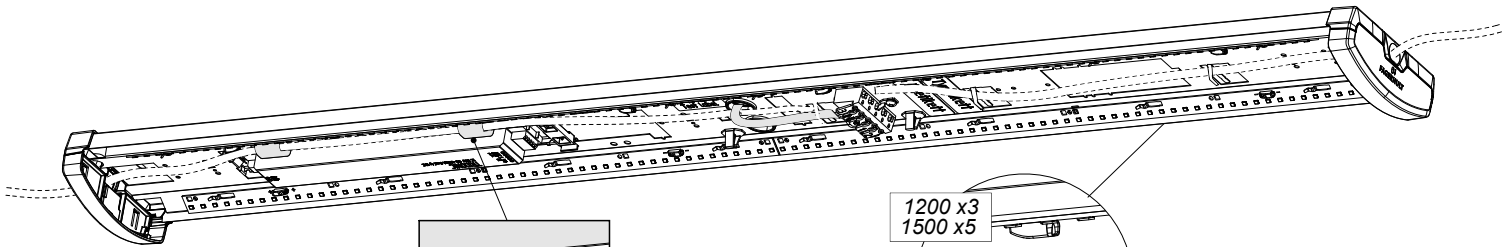
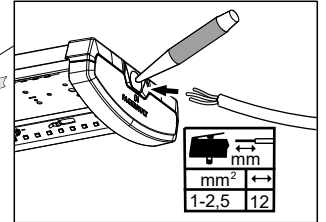
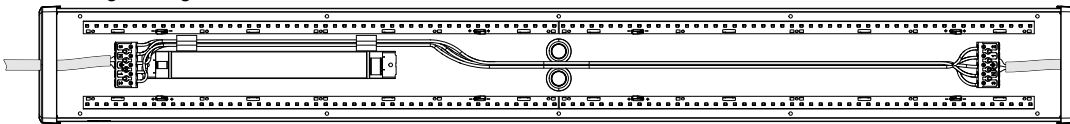

Diffuser

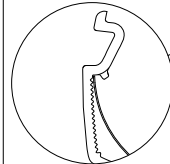

S Ljuskälla och drivdon ska enbart bytas ut av tillverkaren eller dess utsedda person.
GB The light source and control gear shall only be replaced by the manufacturer or its designated person.

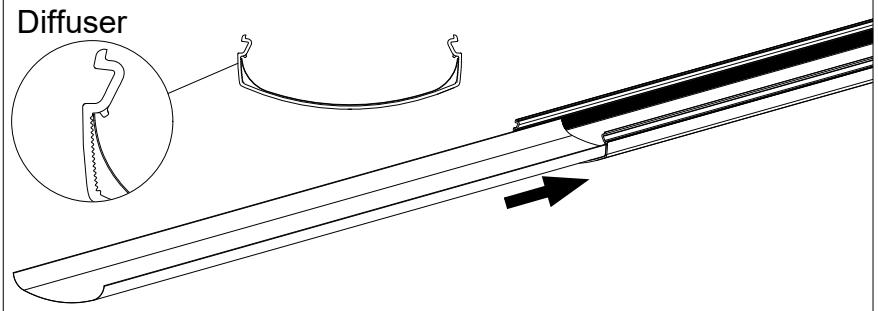
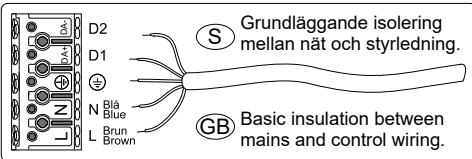

S Det är lämpligt att denna information överlämnas till användaren av anläggningen.

GB It is appropriate that this information is passed on to the users of the installation.

Manufactured by Fagerhult
 For UK market importer Fagerhult UK
 33-34 Dolben Street, London, SE1 0UQ