



#### CARE INSTRUCTIONS

Daily cleaning can be done by wiping the frame with a clean dry cloth. Should the surface need more attention this can be cleaned with water and a light detergent or soap applied with a damp cloth. Wipe after with a clean dry cloth. Avoid any abrasive materials.

#### TROUBLESHOOTING

If lamp does not light, turn off the power. Check the bulb for a broken filament. Replace bulb if necessary, then turn it on. If the lamp still does not light, please contact customer service at the local dealer. If the external flexible cable or cord of this lamp is damaged, it must be replaced by a qualified electrician in order to avoid a hazard.

#### TECHNICAL INFORMATION

Light sources: E27, 810 Lumen (6-10W LED).  
Turn power off when changing light bulb. Isolation class III.  
The lamp is approved for outdoor use and in damp/wet rooms (IP65)



For enquiries contact GUBI A/S - CVR: 17940384  
Orientkaj 18-20. 2150 Nordhavn. Copenhagen, Denmark  
T +45 69 15 60 60 – [order@gubi.com](mailto:order@gubi.com)  
[GUBI.COM](http://GUBI.COM)

# GUBI

ASSEMBLY INSTRUCTIONS

*for*

## SATELLITE FLOOR LAMP

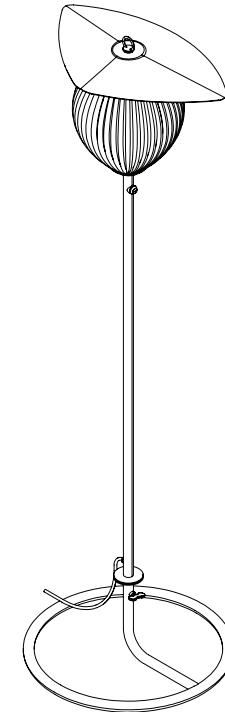

## CONTENTS

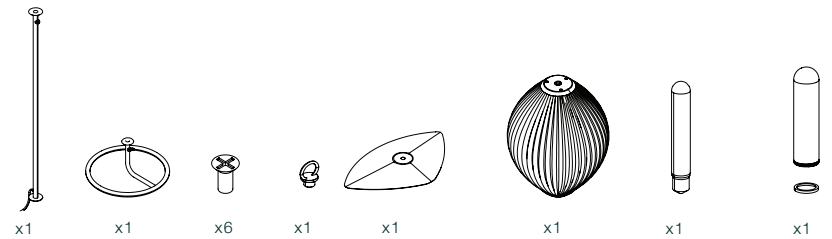

### 1.

Install the stem and lampshade by placing it into the base (1a).  
Make sure to tight the stem to base with the fingerscrew (1b).

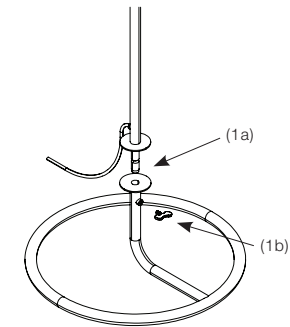

### 2.

Unscrew 3 screws on stem connection (2a) tilt the shade  
and unscrew the 3 screws on bottom plate (2b) to access  
the socket.

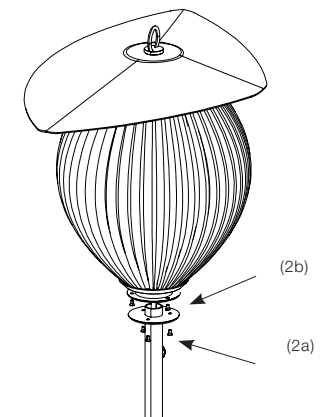

### 3.

Insert lightbulb (3a), silicone stopper (3b) and transparent plastic cover (3c). Make sure that all 3 parts are installed properly.

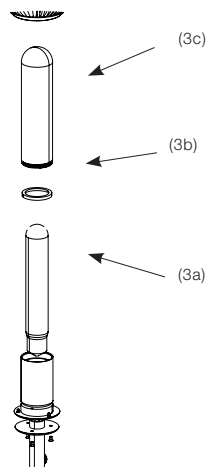

Re-assemble the lamp by following step 2 in reverse.

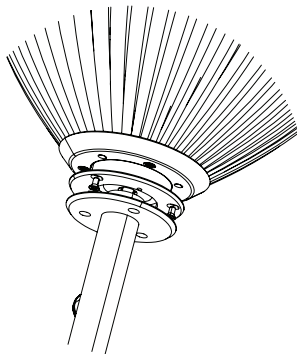

### 4.

Assemble the top part by placing the hat (4a) on top of the shade and attach with the screw (4b). Make sure it's properly tightened.

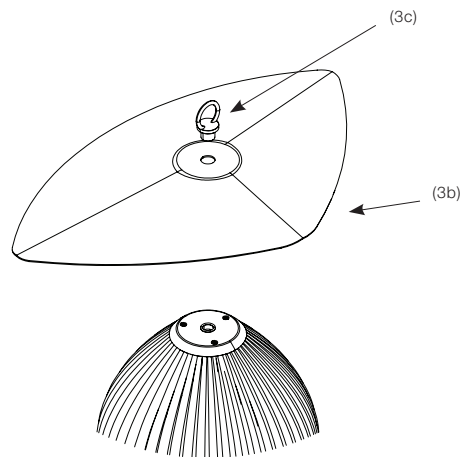

Plug in the lamp and turn it on by using the button placed on the stem.

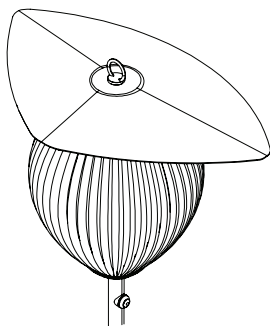

## PIN



x1

### 1.

Install pin in the desired substrate (1a) When the bottom disc touches the surface, pin is securely installed.  
Place the stem into the pin (1b).  
Make sure to tight the stem to pin with the fingerscrew (1c).

