

D208 STRATO 190



Model: D208

Input: DC 350mA

Power: 16W



SAFETY INSTRUCTIONS

-The appliance should be installed, connected and tested by qualified electrician, and in accordance with local regulations.

-Turn off the power supply before installation or maintenance of the appliance, and make sure that the cables will not be squeezed or damaged by sharp edges.

-Clean the appliance with a soft cloth and a standard PH neutral detergent. Stainless steel surfaces should be maintained regularly.

-Misuse of, or changes to the appliance shall nullify the guarantee. The manufacturer is free to change the design, specifications and instructions for assembly.

THE APPLIANCE SHOULD NOT BE COVERED BY INSULATION BLANKET OR SIMILAR MATERIALS IN ANY CASE.

**⚠ DO NOT TOUCH OR CLEAN THE LED ARRAY !
IN ORDER TO AVOID DAMAGE THE LED CHIP !**

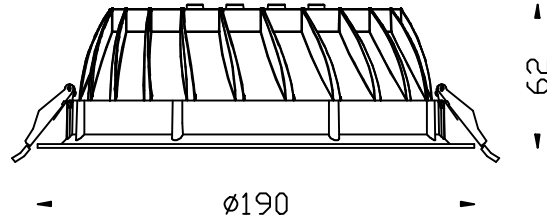

1

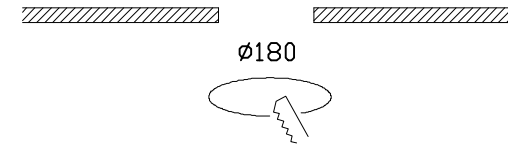

2

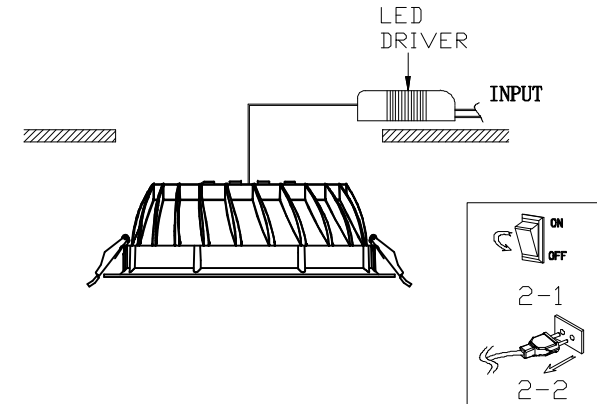

3

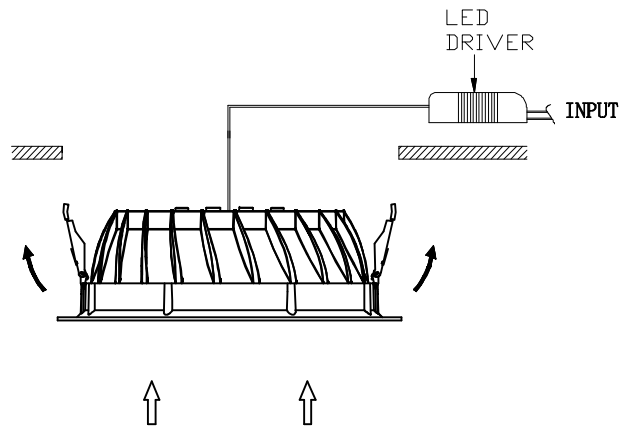

4

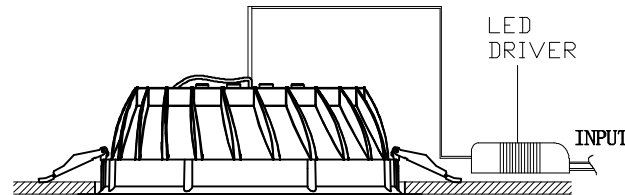

5

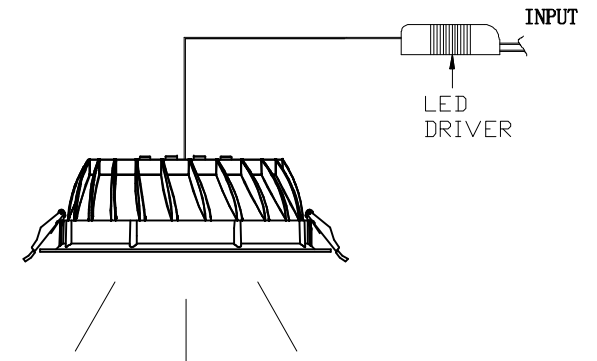

CONNECT IN SERIES

