

**9624355**

36W LED / 36W Total  
incl. LED Board: L9002460  
230V ~ 50Hz

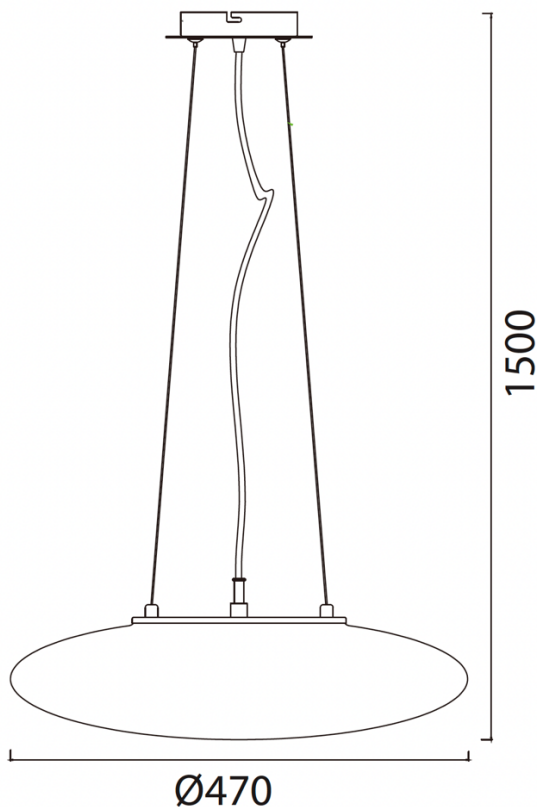

Maßeinheit/Unit of measure/ Unité de mesure: **mm**

**(DE) Bestimmungsgemäße Verwendung**

**(EN) Intended use | (FR) Utilisation conforme | (NL) Beoogd gebruik | (PL) Stosowanie zgodnie z przeznaczeniem | (NO) Riktig bruk | (DK) Korrekt brug  
(SE) Avsedd användning | (FI) Määräystenmukainen käyttö | (IT) Impiego appropriato | (ES) Uso prescrito | (CZ) Použití v souladu s určením  
(PT) Utilização correta | (GR) Ενδεδειγμένη χρήση | (SK) Predpokladané použitie | (EE) Eeldatav kasutus | (LV) Paredzams lietojums  
(LT) Numatomas naudojimas | (RO) Utilizare intenționată | (SI) Predvidena uporaba | (HR) Namjenska upotreba | (HU) Tervezett felhasználás  
(BG) предназначена употреба | (AL) Përdorimi i parashikuar | (MK) Предвидена употреба | (TR) Amaçlı kullanım | (UK) Призначене використання  
(BA,ME,RS) Namjenska upotreba**

|   |   |
|---|---|
| <b>(DE)</b> Ortsfeste Verwendung als Hängeleuchte im Innenbereich         | <b>(GB)</b> For stationary use indoors as a pendant light                 |
| <b>(FR)</b> Utilisation stationnaire en tant que suspension d'intérieur   | <b>(NL)</b> Vast gebruik als hanglamp binnenshuis                         |
| <b>(PL)</b> Do montażu stacjonarnego jako lampa wisząca do wnętrza        | <b>(NO)</b> Til stasjonært bruk som pendellampe innendørs                 |
| <b>(DK)</b> Til stationær brug som pendellampe indendørs                  | <b>(SE)</b> Används som fast hänglampa inomhus                            |
| <b>(FI)</b> Kiinteä käyttö sisätilojen riippuvälisimena                   | <b>(IT)</b> Impiego fisso come lampada a sospensione in ambienti interni  |
| <b>(ES)</b> Empleo fijo en tanto lámpara colgante en interiores           | <b>(CZ)</b> Stacionární použití jako závěsné svítidlo v interiéru         |
| <b>(PT)</b> Aplicação fixa como candeeiro suspenso em interiores          | <b>(GR)</b> Σταθερή χρήση ως κρεμαστό φωτιστικό σε εσωτερικό χώρο         |
| <b>(SK)</b> Na stacionárne použitie v interiéri ako závesné svetlo        | <b>(BG)</b> За стационарна употреба на закрито като висяща светлина       |
| <b>(EE)</b> Statsionaarseks kasutamiseks siseruumides rippvõlgustina      | <b>(LV)</b> Stacionārai lietošanai iekštelpās kā piekaramais apgaismojums |
| <b>(LT)</b> Stacionariam naudojimui patalpose kaip pakabinamas šviestuvus | <b>(RO)</b> Pentru utilizare staționară în interior ca lumină suspendată  |
| <b>(SI)</b> Za stacionarno uporabo v notranjosti kot viseča luč           | <b>(HR)</b> Za stacionarnu upotrebu u zatvorenom prostoru kao visilica    |
| <b>(HU)</b> Helyhez kötött beltéri használatra függőlámpaként             | <b>(AL)</b> Për përdorim të palëvizshëm brenda si dritë pendeli           |
| <b>(MK)</b> За стационарна употреба внатре како светилка со висечка       | <b>(TR)</b> Sabit kullanım için iç mekanda avize olarak                   |
| <b>(UK)</b> Для стаціонарного використання всередині як підвісне світило  | <b>(BA)</b> Za stacionarnu upotrebu unutar kao viseća svjetiljka          |
|   | <b>(ME)</b>   |
|   | <b>(RS)</b>   |

| (DE) Lieferumfang  |   |   |
|--|---|---|
| (EN) Package contents   (FR) Contenu de la livraison   (NL) Bij de levering inbegrepen   (PL) Zakres dostawy   (NO) Levering   (DK) Leveringsomfang<br>(SE) Leveransomfattning   (FI) Toimitussisältö   (IT) Fornitura   (ES) Volumen de suministro   (CZ) Rozsah dodávky   (PT) Material fornecido<br>(GR) Παραδοτέος εξοπλισμός   (SK) Obsah balenia   (EE) Pakendi sisu   (LV) Pakas saturs   (LT) Pakuotės turinys<br>(RO) Conținutul pachetului   (SI) Vsebina paketa   (HR) Sadržaj paketa   (HU) A csomag tartalma   (BG) обхват на доставката<br>(AL) Përmbajtja e dorëzimit   (MK) Содржина на испорака   (TR) Teslimat içeriği   (UK) Зміст доставки   (BA,ME,RS) Sadržaj isporuke |   |   |
| (DE) 1 Hängeleuchte<br>Montagematerial<br>Montageanleitung   | (GB) 1 Pendant light<br>Installation hardware<br>Mounting instructions      | (FR) 1 Suspension<br>Matériel de montage<br>Instructions de montage                 |
| (NL) 1 Hanglamp<br>Monteringsmateriale<br>Montagehandleiding   | (PL) 1 Lampa wisząca<br>Elementy montażowe<br>Instrukcja montażu            | (NO) 1 Pendellampe<br>Monteringsmateriale<br>Brukerveiledning                       |
| (DK) 1 Pendellampe<br>Monteringsmateriale<br>Brugervejledning  | (SE) 1 Hänglampa<br>Monteringsmaterial<br>Monteringsanvisning               | (FI) 1 Riippuvalaisin<br>Asennus materiaali<br>Asennusohjeet                        |
| (IT) 1 Lampada a sospensione<br>Materiale di montaggio<br>Istruzioni di montaggio  | (ES) 1 Lámpara colgante<br>Material de montaje<br>Instrucciones de montaje  | (CZ) 1 Závěsné svítidlo<br>Materiál pro montáž<br>Návod k montáži                   |
| (PT) 1 Candeeiro suspenso<br>Material de montagem<br>Instruções de montagem  | (GR) 1 Κρεμαστό φωτιστικό<br>Υλικά συναρμολόγησης<br>Οδηγίες συναρμολόγησης | (SK) 1 závesné svetlo<br>Inštalčný hardvér<br>Inštalčná príručka                    |
| (BG) 1 висяща лампа<br>материали за монтаж<br>инструкции за монтаж   | (EE) 1 rippvalgusti<br>Paigaldustarvikud<br>Paigaldusjuhend                 | (LV) 1 piekaramais gaismeklis<br>Instalācijas aparatūra<br>Uzstādīšanas instrukcija |
| (LT) 1 pakabinamas šviestuvos<br>Montavimo aparatinė įranga<br>Montavimo instrukcija   | (RO) 1 lampă suspendată<br>Hardware de instalare<br>Instrucțiuni de montare | (SI) 1 obesek<br>Namestitvena strojna oprema<br>Navodila za montažo                 |
| (HR) 1 Visilica<br>Instalacijski hardver<br>Upute za montažu   | (HU) 1 függőlámpa<br>Telepítési hardver<br>Szerelési útmutató               | (AL) 1 dritë pendeli<br>Materiali i montimit<br>Udhëzuesi i montimit                |
| (MK) 1 светилка со висечка<br>Монтажен материјал<br>Упатство за монтажа  | (TR) 1 asma lamba<br>Montaj malzemesi<br>Montaj kılavuzu                    | (UK) 1 підвісний світильник<br>Монтажний матеріал<br>Інструкція з монтажу           |
| (BA) 1 svjetiljka sa vješalicom<br>(ME) Montažni materijal<br>(RS) Uputstvo za montažu   |   |   |

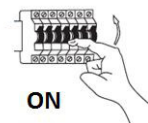
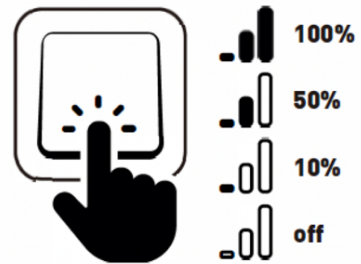
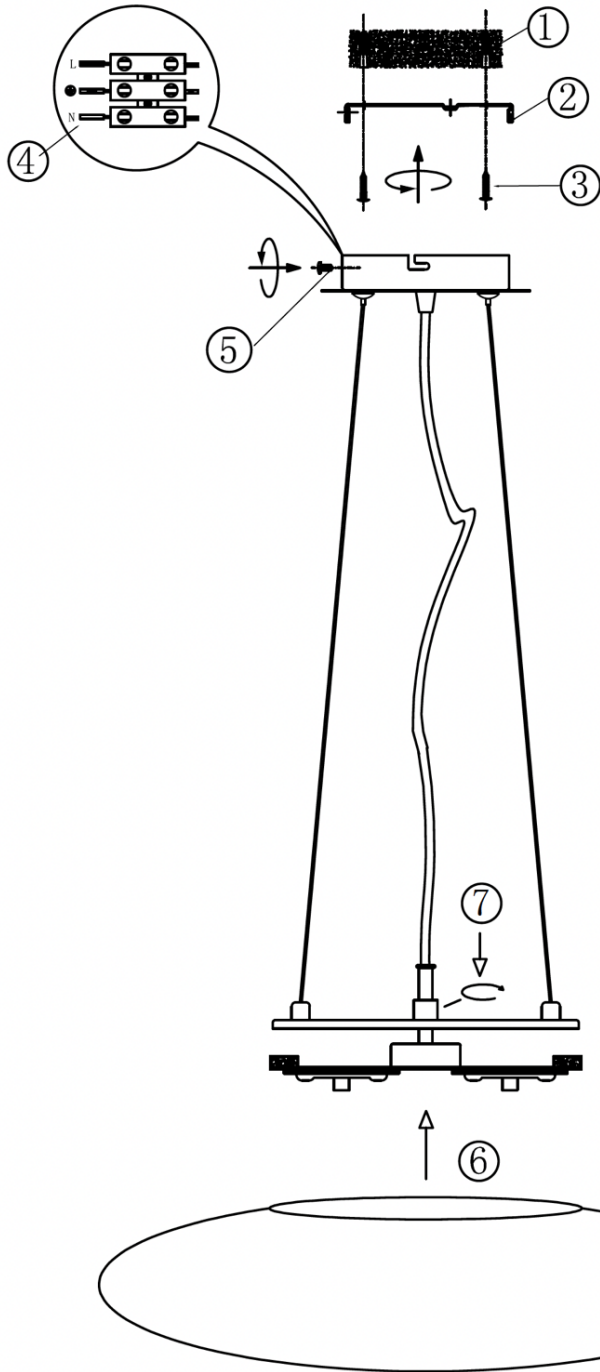
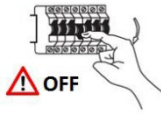

|   | (DE)                  | (EN)              | (FR)                             | (NL)                   | (PL)                | (NO)               |
|---|-----------------------|-------------------|----------------------------------|------------------------|---------------------|--------------------|
| <b>L</b>  | Stromführender Leiter | Live conductor    | Conducteur                       | Spanningvoerende draad | Przewód prądowy     | Strømførende leder |
|  | Schutzleiter          | Earth conductor   | Conducteur de protection (terre) | Aardkabel              | Przewód uziemiający | Jordledningen      |
| <b>N</b>  | Neutralleiter         | Neutral conductor | Conducteur neutre                | Nulleider              | Przewód zerowy      | Nøytralleder       |

|   | (DK)               | (SE)                | (FI)        | (IT)                      | (ES)                    | (CZ)              |
|---|--------------------|---------------------|-------------|---------------------------|-------------------------|-------------------|
| <b>L</b>  | Strømførende leder | Strömförande ledare | Virtajohdin | Conduttore sotto tensione | Conductor de corriente  | Vodič pod napětím |
|  | Jordledningen      | Skyddsledare        | Suojajohdin | Conduttore di terra       | Conductor de protección | Ochranný vodič    |
| <b>N</b>  | Neutralleder       | Neutralledare       | Nollajohdin | Conduttore neutro         | Conductor neutro        | Neutrální vodič   |

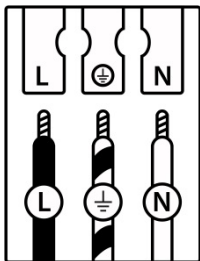

|  | (PT)              | (GR)                | (SK)            | (EE)         | (LV)                | (LT)                 |
|--|-------------------|---------------------|-----------------|--------------|---------------------|----------------------|
| <b>L</b>   | Condutor vivo     | Ρευματοφόρος αγωγός | Živý vodič      | Faasisuht    | Dzīvais vadītājs    | Gyvas dirigentas     |
|  | Condutor de terra | Αγωγός γείωσης      | Zemný vodič     | Maandusuht   | Zemes vadītājs      | Žemės dirigentas     |
| <b>N</b>   | Condutor neutro   | Ουδέτερος αγωγός    | Neutrálny vodič | Neutraalsuht | Neitrālais vadītājs | Neutrinis dirigentas |

|   | (RO)                     | (SI)               | (HR)               | (HU)            | (BG)                     | (AL)               |
|---|--------------------------|--------------------|--------------------|-----------------|--------------------------|--------------------|
| <b>L</b>  | Conductor viu            | Živi dirigent      | Živi dirigent      | Élő vezető      | проводник под напряжение | Konduktor i gjallë |
|  | Conductor de împământare | Zemeljski dirigent | Uzemljeni dirigent | Földvezető      | защитен проводник        | Dirigjent i tokës  |
| <b>N</b>  | Conductor neutru         | Nevtralni dirigent | Neutralni dirigent | Semleges vezető | нулев проводник          | Kondaktor neutral  |

|   | (MK)                | (TR)            | (UK)                  | (BA)(ME)(RS)        |
|---|---------------------|-----------------|-----------------------|---------------------|
| <b>L</b>  | Жив кондуктор       | Canlı yönetici  | Живий диригент        | Živi dirigent       |
|  | Земјен проводник    | Toprak iletkeni | Земельний провідник   | Zemaljski provodnik |
| <b>N</b>  | Неутрален проводник | Nötr iletken    | Нейтральний провідник | Neutralni provodnik |

### (DE) Verwendete Symbole

(EN) Safety Precautions | (FR) Symboles utilisés | (NL) Gebruikte symbolen | (PL) Stosowane symbole | (NO) Brukte symboler | (DK) Brugte symboler | (SE) Använda symboler | (FI) Käytetyt symbolit | (IT) Simboli usati | (ES) Símbolos empleados | (CZ) Použité symboly | (PT) Símbolos utilizados | (GR) Χρησιμοποιούμενα σύμβολα | (SK) Bezpečnostné opatrenia | (EE) Ohutusabinõud | (LV) Drošības pasākumi | (LT) Saugos priemonės | (RO) Măsuri de precauție | (SI) Varnostni ukrepi | (HR) Mjere opreza | (HU) Használt szimbólumok | (BG) Мерки за безопасност | (AL) Simbolet e përdorura | (MK) Користени симболи | (TR) Kullanılan semboller | (UK) Використовувані символи | (BA,ME,RS) Korišteni simboli

IP 20

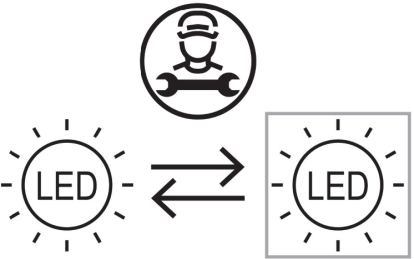

|  |  |  |
|--|--|--|
| <p>(DE) Dieses Produkt enthält eine Lichtquelle der Energieeffizienzklasse F<br/>         (EN) This product contains a light source of energy efficiency class F<br/>         (FR) Ce produit comprend une source de lumière de classe d'efficacité énergétique F<br/>         (NL) Dit product bevat een lichtbron van energie-efficiëntieklasse F<br/>         (PL) Produkt ten zawiera źródło światła o klasie efektywności energetycznej F<br/>         (NO) Dette produktet inneholder en lyskilde i energieeffektivitetsklasse F<br/>         (DK) Dette produkt indeholder en lyskilde af energieeffektklasse F<br/>         (SE) Denna produkt innehåller en ljuskälla i energieffektivitetsklass F<br/>         (FI) Tämä tuote sisältää energiatehokkuusluokan F valonlähteen<br/>         (IT) Questo prodotto contiene una sorgente luminosa della classe di efficienza energetica F<br/>         (ES) Este producto contiene una fuente de luz de la clase de eficiencia energética F<br/>         (CZ) Tento výrobek obsahuje světelný zdroj třídy energetické účinnosti F<br/>         (PT) Este produto contém uma fonte de luz da classe de eficiência energética F<br/>         (GR) Αυτό το προϊόν περιέχει μια φωτεινή πηγή ενεργειακής απόδοσης κλάσης F<br/>         (SK) Tento výrobok obsahuje zdroj svetla triedy energetickej efektivity F<br/>         (EE) See toode sisaldab energiatõhususklassi F valgusallikat<br/>         (LV) Šis produkts satur enerģijas efektivitātes klases F gaismas avotu<br/>         (LT) Šis gaminys turi energijos efektyvumo klasės F šviesos šaltinį<br/>         (RO) Acest produs conține o sursă de lumină de clasă de eficiență energetică F<br/>         (SI) Ta izdelek vsebuje svetlobni vir energijskega razreda F<br/>         (HR) Ovaj proizvod sadrži izvor svjetlosti energetske učinkovitosti klase F<br/>         (HU) Ez a termék egy F energiahatékonysági osztályú fényforrást tartalmaz<br/>         (BG) Този продукт съдържа източник на светлина с клас на енергийна ефективност: F<br/>         (AL) Ky produkt përmban një burim drite të klasës së efikasitetit të energjisë F<br/>         (MK) Овој производ содржи извор на светлина од класа на енергетска ефикасност F<br/>         (TR) Bu ürün, enerji verimliliği sınıfı F olan bir ışık kaynağı içerir<br/>         (UK) Цей продукт містить джерело світла класу енергоефективності F<br/>         (BA)(ME)(RS) Ovaj proizvod sadrži izvor svjetlosti energetske klase F</p> | <p style="text-align: center;"><b>QR</b></p>  | <p style="text-align: center;"><b>EAN</b></p> <p style="text-align: center;">4251911754414</p> |
|--|--|--|

|   |  |
|---|--|
|  | <p>(DE) Durch einen Fachmann austauschbare Lichtquelle (nur LED).<br/>         (EN) Replaceable (LED only) light source by a professional.<br/>         (FR) Source de lumière remplaçable (LED uniquement) par un professionnel.<br/>         (NL) Lichtbron (alleen led) te vervangen door een professional.<br/>         (PL) Wymienne (tylko LED) źródło światła wykonane przez profesjonalistę.<br/>         (NO) Utskiftbar (kun LED) lyskilde av en profesjonell.<br/>         (DK) Udskiftelig lyskilde (kun LED), udskiftes af en elektriker.<br/>         (SE) Ljuskälla (endast LED) utbytbar genom fackman.<br/>         (FI) Ammattilainen voi vaihtaa vaihdettavan (vain LED) valonlähteen.<br/>         (IT) Sorgente luminosa (solo LED) sostituibile da un professionista.<br/>         (ES) Fuente de luz (solo LED) sustituible por un profesional.<br/>         (CZ) Výměnitelný (pouze LED) světelný zdroj odborníkem.<br/>         (PT) Luz LED (apenas LED) substituível por um profissional.<br/>         (GR) Η πηγή φωτός (μόνο LED) να αντικαθίσταται από επαγγελματία.<br/>         (SK) Zdroj svetla (iba LED) vymeniteľný prostredníctvom odborníka.<br/>         (EE) Spetsialisti poolt vahetatav valgusallikas (ainult LED).<br/>         (LV) Speciālista maināms gaismas avots (tikai LED).<br/>         (LT) Specialisto keičiamas šviesos šaltinis (tik LED).<br/>         (RO) Sursă de lumină schimbabilă de către un specialist (doar LED).<br/>         (SI) Svetlobni vir, ki ga lahko zamenja strokovnjak (samo LED).<br/>         (HR) Izvor svjetlosti koji može zamijeniti stručnjak (samo LED).<br/>         (HU) Szakember által cserélhető (csak LED) fényforrás.<br/>         (BG) Светлинен източник, който може да се смени от специалист (само LED).<br/>         (AL) Burim drite i zëvendësueshëm (LED vetëm) nga një profesionist.<br/>         (MK) Изворот на светлина (само LED) се заменува од професионалец.<br/>         (TR) Değiştirilebilir (yalnızca LED) ışık kaynağı bir profesyonel tarafından değiştirilir.<br/>         (UK) Замінний (тільки LED) джерело світла замінюється фахівцем.<br/>         (BA)(ME)(RS) Zamjenjiv (samo LED) izvor svjetlosti zamjenjuje profesionalac.</p> |
|---|--|