

ITKA

floor

Naoto Fukasawa | 2008

DANESE

MILANO



Ø 50

MADE IN ITALY



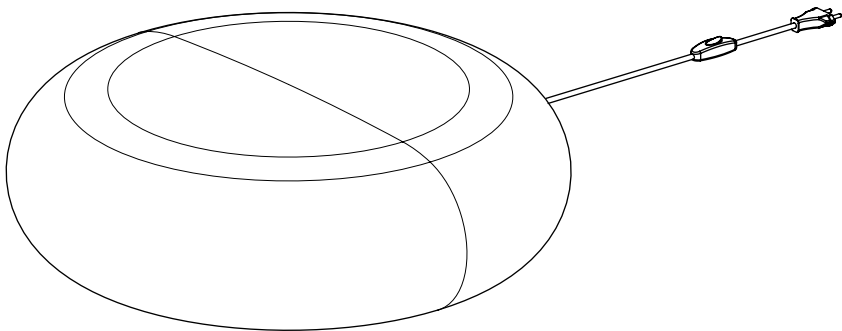
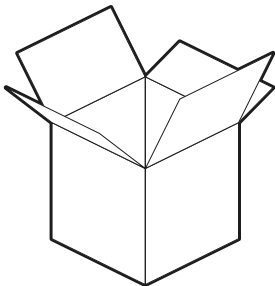
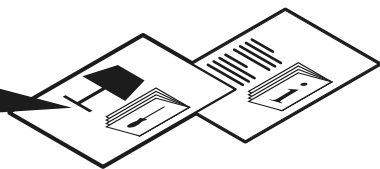

Fig.1

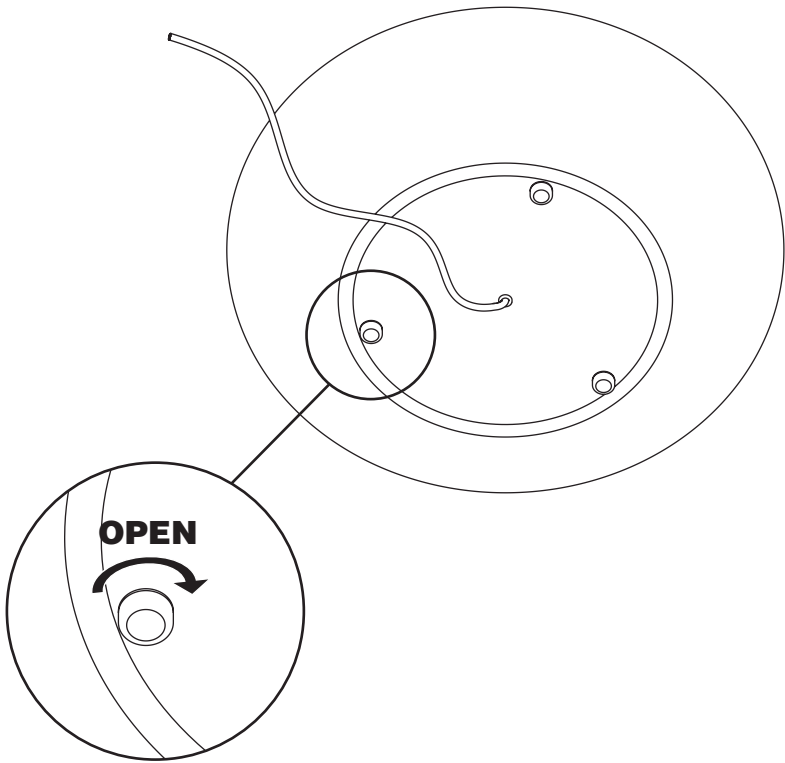

Fig.2

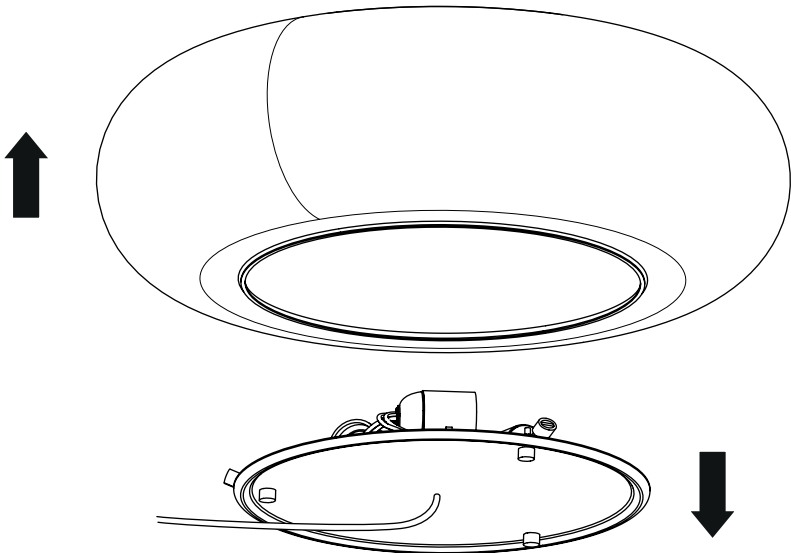
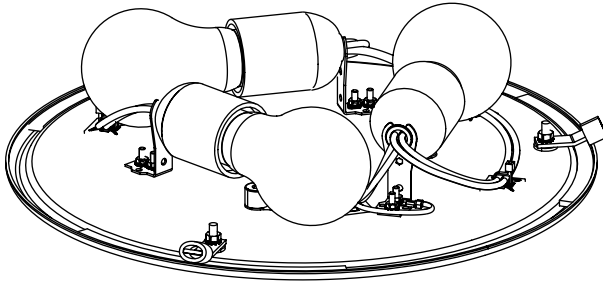

Fig.3



220 - 240 V / 50 - 60 Hz	
MAX 22W (E27)	
Fluo: FBT	1300 lm
LED: DRAA	1000 lm

120 V / 60 Hz	
MAX 23W (E26) TYPE SBCFL	

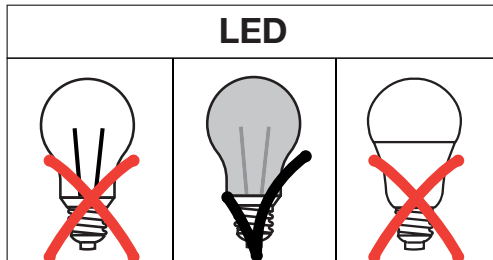

Fig.4

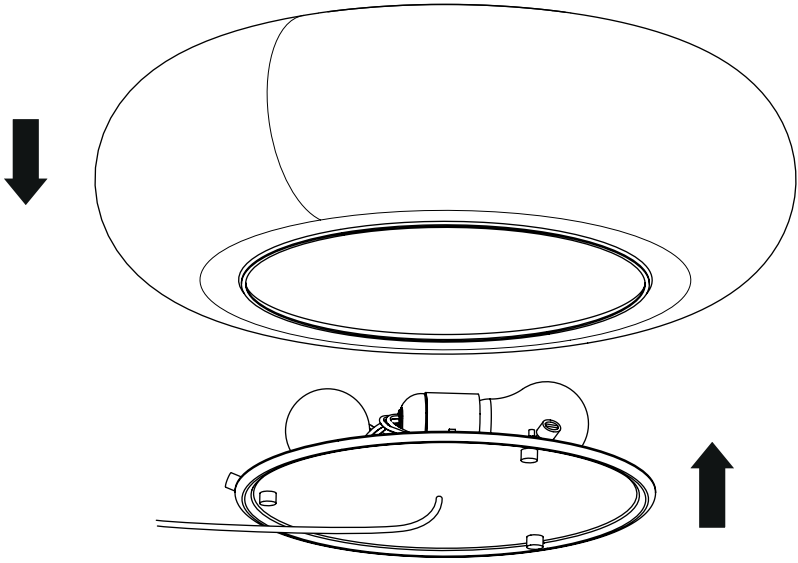

Fig.5

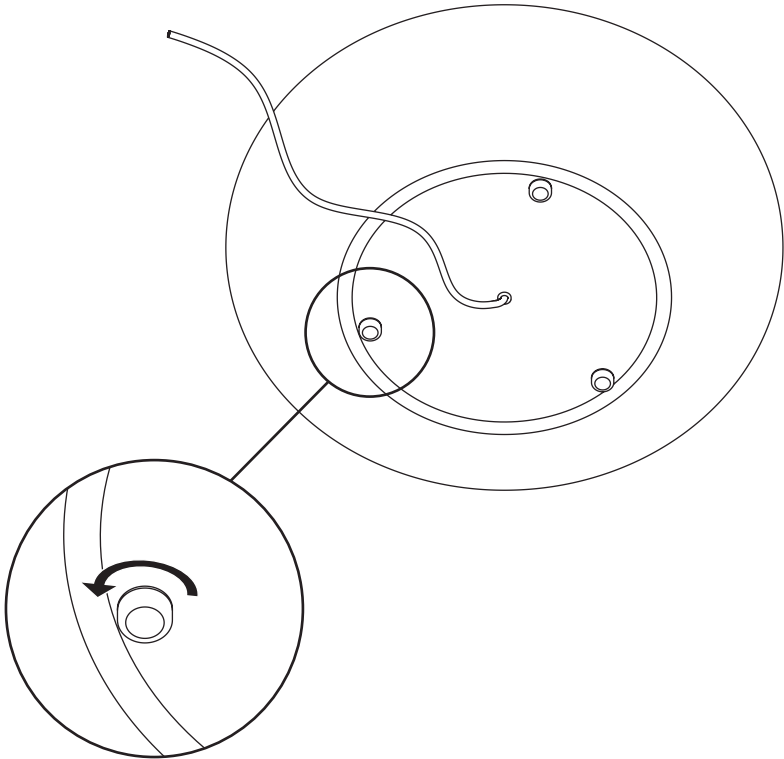
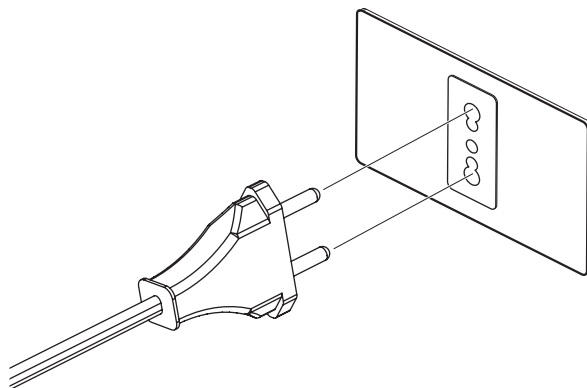

Fig. 6



220 - 240 V



120 V

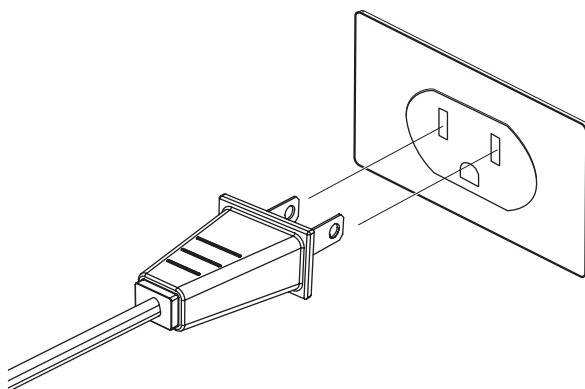
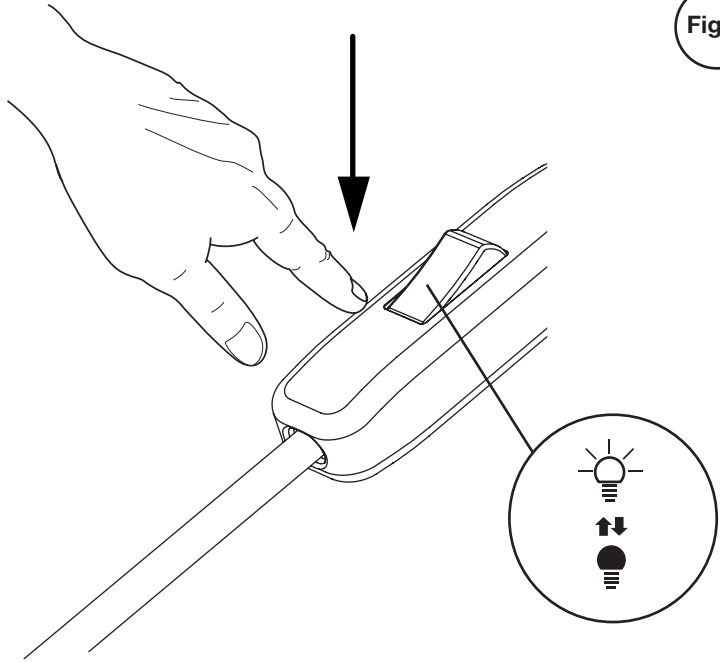
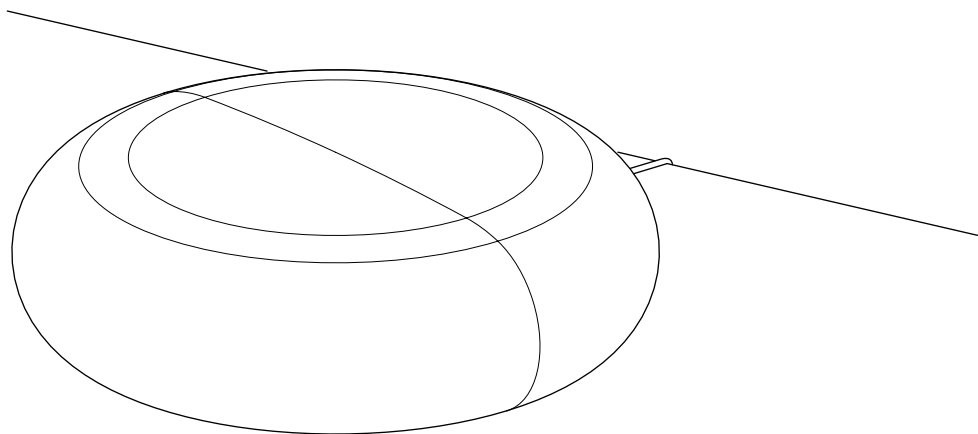
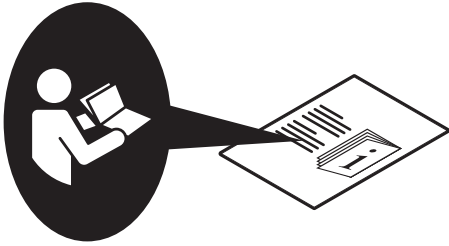

Fig. 7









FOR USA AND CANADA ONLY

IMPORTANT SAFETY INSTRUCTIONS

THIS PORTABLE LAMP HAS A POLARIZED PLUG (ONE BLADE IS WIDER THAN THE OTHER ONE). AS A SAFETY FEATURE, THIS PLUG WILL FIT IN A POLARIZED OUTLET ONLY ONE WAY. IF THE PLUG DOES NOT FIT FULLY IN THE OUTLET, REVERSE THE PLUG. IF IT STILL DOES NOT FIT, CONTACT A QUALIFIED ELECTRICIAN. NEVER USE WITH AN EXTENSION CORD UNLESS PLUG CAN BE FULLY INSERTED. DO NOT ATTEMPT TO DEFEAT THIS SAFETY FEATURE.

INSTRUCTIONS IMPORTANTES DE SECURITE

CETTE LAMPE PORTATIVE A UNE FICHE POLARISANTE (UNE LAMPE EST PLUS GRANDE QUE L'AUTRE) COMME CARACTERISTIQUE. CETTE FICHE N'ENGAGE QU' UNE PRISE POLARISANTE. SI LA FICHE N'ENGAGE PAS COMPLETEMENT LA PRISE, IL FAUT LA RENSER; SI ELLE N'ENGAGE TOUJOURS PAS, METTEZ VOUS EN RAPPORT AVEC UN ELECTRICIEN QUALIFIE. NE JAMAIS UTILISER AVEC UN PROLONGATEUR SI LA FICHE N'ENGAGE PAS COMPLETEMENT. NE CHANGER PAS LA FICHE

DANESE

VIA ANTONIO CANOVA 34

20145 MILANO

T. +39.02.349611

F. +39.02.34538211

info@danese milano.com

www.danese milano.com

SHOWROOM

PIAZZA SAN NAZARO IN BROLO 15

20122 MILANO

T. +39.02.58304150

F. +39.02.58433350

showroomdanese@artemide.com

DANESE



MILANO | Artemide®

VIA BERGAMO 18

20010 PREGNANA MILANESE (MI) ITALY

T. +39.02.935181 - 935261

Numero Verde 800 834 093 (from Italy only)

© JULY 2016 DANESE

DANESE reserves the right to change, at any time and without prior warning, the technical specification of any product illustrated in this instruction.

cod. Y513000621

Artemide Inc.

250 Karin Lane

Hicksville, NY 11801

T. 631 694 9292

toll free 1-877-Art-9111

fax 631 694 9275

www.artemide.net

Artemide Ltée/Ltd.

11105 rue Renaude Lapointe

Montréal, Québec H1J 2T4

T. 514 323 6537

toll free 888 777 2783

fax 514 323 8864

www.artemide.net