

Fabbian

50 via Santa Brigida
31020 Castelmio di Resana
Treviso, Italy Tel +39 0423 4848 fax +39 423 484395
fabbian@fabbian.com www.fabbian.com

CUBETTO D28E04-D28E54





I

ATTENZIONE: LA SICUREZZA DELL'APPARECCHIO È GARANTITA SOLO CON L'USO APPROPRIATO DELLE SEGUENTI ISTRUZIONI. CONSERVARLE CON CURA.

AVVERTENZE

Prima di eseguire qualsiasi tipo di operazione togliere la tensione in rete.
Fare attenzione a non superare il Max di watt indicati per l'apparecchio.
L'apparecchio non può essere usato in ambienti umidi o all'esterno.
Per la pulizia dei vetri si raccomanda di non usare mai abrasivi o solventi.
Mai coprire l'apparecchio durante il funzionamento.

L'apparecchio deve essere equipaggiato con lampade autoprotette che non necessitano di schermo di protezione.

Potenza massima della lampada. 3x48W
Attacco lampada. G9 
Tipo lampada. Halopin 
Apparecchio classe II 
Classe di protezione. IP20 





GB

ATTENTION: THE SAFETY OF THE APPLIANCE IS GUARANTEED ONLY IF IT IS PROPERLY USED, ACCORDING TO THE FOLLOWING INSTRUCTIONS, WHICH ARE TO BE KEPT.

WARNING

Always disconnect the power supply before installing or performing any maintenance operations.
Make attention of not exceeding the maximum watt indicated on the appliance.
The appliance may not be used in humid or external environments.
Never cover the appliance while in function.
For cleaning the glass do not use any abrasive or solvent materials.

The symbol mains the use of self-protection lamps which don't need of any protection screen.

Capacity of bulb. 3x48W
Type of lampholder. G9 
Type of bulb. Halopin 
Appliance in class II 
Protection class. IP20 





D

ACHTUNG: DIE SICHERHEIT DIESER BELEUCHTUNGSKÖRPER WIRD NUR DURCH DIE KORREKTE ANWENDUNG DER NACHSTEHENDEN ANWEISUNGEN GEWÄHRLEISTET. DIESE ÜSSEN DAHER SORGFÄLIG AUFBEWAHRT WERDEN!

WICHTIGE HINWEISE

Bevor irgendwelche Arbeitsgänge ausgeführt werden, muß die Stromversorgung unterbrochen.
Der Beleuchtungskörper darf nicht in feuchten Räumen bzw. im Freien eingesetzt werden.
Zur Reinigung der Gläser dürfen keine Scheuer- bzw. Lösungsmittel verwendet werden.
Achten Sie darauf, daß die auf dem Beleuchtungskörper angegebene maximale Wattzahl nicht überschritten wird.
Den Beleuchtungskörper während dem Betrieb nicht abdecken.

The symbol mains the use of self-protection lamps which don't need of any protection screen.

Leistung der Gluehbirne. 3x48W
Anschluss. G9 
Typ der Gluehbirne. Halopin 
Gerät der Klasse II 
Schutzklasse. IP20 





RU

ВНИМАНИЕ: БЕЗОПАСНОСТЬ ОСВЕТИТЕЛЬНОГО ПРИБОРА ГАРАНТИРОВАНА ТОЛЬКО ПРИ УСЛОВИИ ЕГО ЭКСПЛУАТАЦИИ В СООТВЕТСТВИИ С ПРИВЕДЕННЫМИ НИЖЕ ИНСТРУКЦИЯМИ, КОТОРЫЕ НЕОБХОДИМО СОХРАНИТЬ.

ВНИМАНИЕ:

Перед выполнением любой операции с осветительным прибором отключить напряжение в сети.
Не превышать максимально допустимую мощность, указанную для данного осветительного прибора.
Осветительный прибор не может быть использован во влажных помещениях или на улице.
Никогда не накрывать осветительный прибор в рабочем режиме.
For cleaning the glass do not use any abrasive or solvent materials.

The symbol mains the use of self-protection lamps which don't need of any protection screen.

Максимальная мощность лампочки. 3x48W
Тип цоколя лампочки. G9 
Тип лампочки. Halopin 
Осветительный прибор КЛАССА II. 
Класс защиты. IP20 





F

ATTENTION: LA SECURITE DE CET APPAREIL N'EST GARANTIE QUE SI L'ON RESPECTE LES INSTRUCTIONS SUIVANTES. IL EST, PAR CONSEQUENT, INDISPENSABLE DE LES CONSERVER SOIGNEUSEMENT.

AVERTISSEMENTS

Avant d'effectuer toute opération, débrancher la tension de réseau.
Veiller à ne pas dépasser la limite maximale des watts indiquée sur l'appareil.
Cet appareil ne peut pas être utilisé dans des pièces humides ni à l'extérieur.
Ne jamais utiliser des abrasifs ou des solvants pour le nettoyage des parties en verre.
Ne jamais couvrir l'appareil pendant son fonctionnement.

The symbol mains the use of self-protection lamps which don't need of any protection screen.

Puissance ampoule. 3x48W
Culot. G9 
Type ampoule. Halopin 
Appareil de classe II 
Classe de protection. IP20 





P

ATENÇÃO: A SEGURANÇA DO APARELHO É GARANTIDA SOMENTE SE FOREM RESPEITADAS AS INSTRUÇÕES. PORTANTO, É NECESSÁRIO CONSERVÁ-LAS.

ADVERTÊNCIAS

Antes de fazer qualquer tipo de operação, desligar a corrente eléctrica da rede.
Prestar atenção para não superar o número de watts indicados para o aparelho.
O aparelho não pode ser utilizado em ambientes húmidos ou no exterior.
Nunca cobrir o aparelho durante o funcionamento.
For cleaning the glass do not use any abrasive or solvent materials.

The symbol mains the use of self-protection lamps which don't need of any protection screen.

Potência máxima da lâmpada. 3x48W
Tipo de suporte da lâmpada. G9 
Tipo de lâmpada. Halopin 
Aparelho de CLASSE II 
Classe de protecção. IP20 





E

ATENCIÓN: LA SEGURIDAD DEL APARATO ESTÁ GARANTIZADA SÓLO POR UN USO ADECUADO DE LAS SIGUIENTES INSTRUCCIONES; POR CONSIGUIENTE, ES PRECISO CONSERVARLAS.

ADVERTENCIAS

Antes de llevar a cabo cualquier tipo de operación, desconectar la tensión de la red.
Prestar atención a no superar el máximo de los vatios indicados en el aparato.
El aparato no podrá utilizarse en ambientes húmedos ni en exteriores.
No cubrir jamás el aparato durante el funcionamiento.
For cleaning the glass do not use any abrasive or solvent materials.

The symbol mains the use of self-protection lamps which don't need of any protection screen.

Potencia máxima de la bombilla. 3x48W
Casquillo de la bombilla. G9 
Tipo de bombilla. Halopin 
Aparato CLASE II 
Clase de protección. IP20 

- Procedere al montaggio seguendo le operazioni in ordine numerico progressivo.
- Proceed with assembling following the operations in progressive numerical order.
- Arbeitsgänge in numerischer Ordnung ausführen, um das Gerät zu installieren.
- Il faut procéder a le montage exécutant les operatoins par l'ordre numerique progressif.



ATTENTION:

- Con vetro NERO usare solamente lampadina con attacco GU10
- BLACK glass use only lamp GU10
- Verre NOIR à utiliser seulement avec lampe GU10
- SCHWARZES Glas benutzbar nur mit der GU10 leuchte

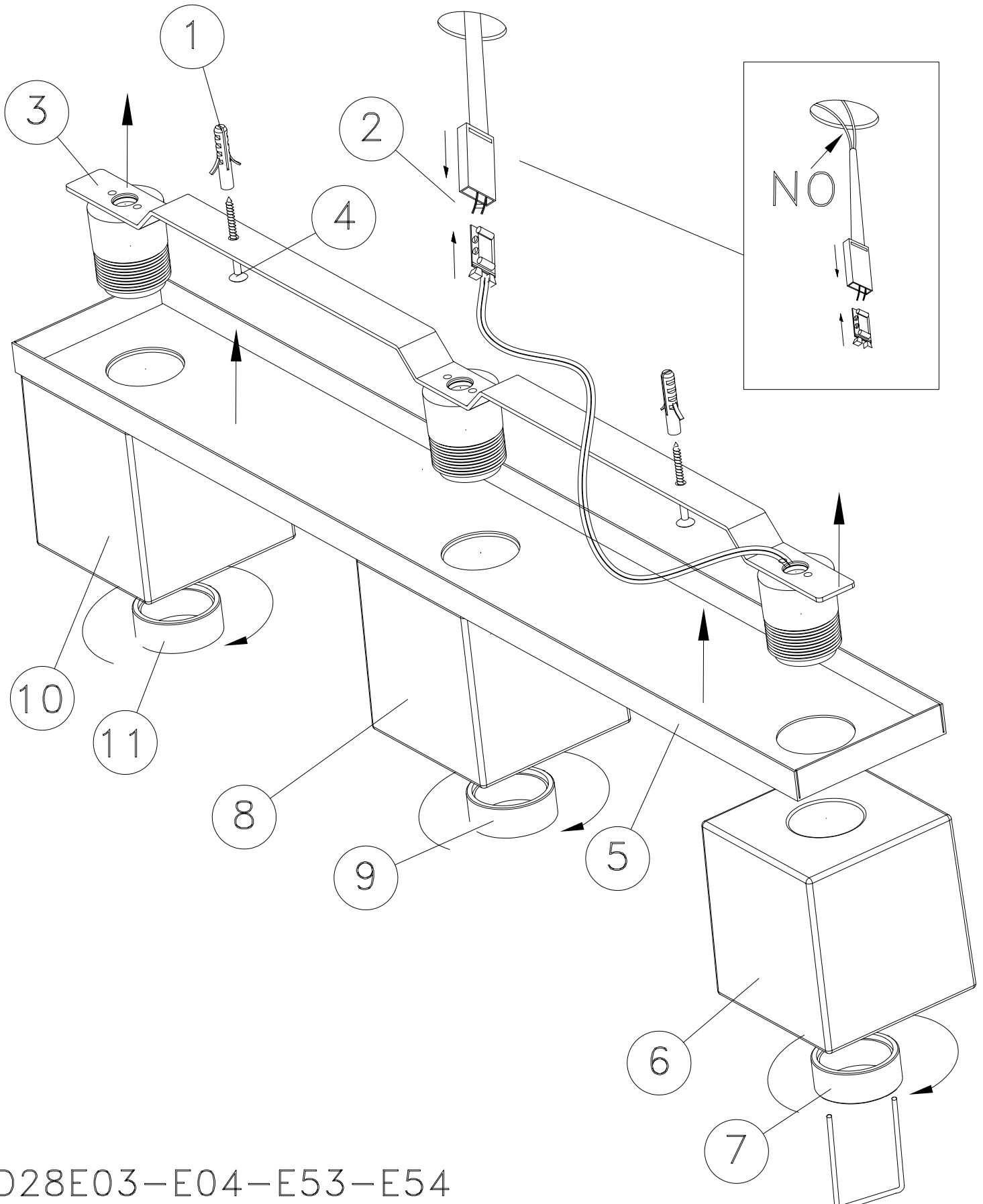

D28E03-E04-E53-E54