

**620 / J / DIM**  
**MINIPISTRELLO**

Design: Gae Aulenti – 1965/2013

  
**martinelli luce**

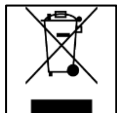

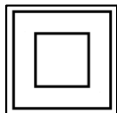
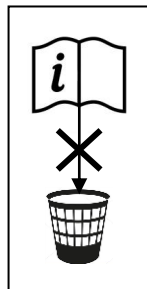
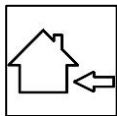
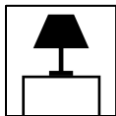

Questo prodotto contiene una sorgente luminosa di classe d'efficienza energetica **F**  
This product contains a light source of energy efficiency class **F**  
Ce produit contient une source lumineuse de classe d'efficacité énergétique **F**  
Este producto contiene una fuente de luz de clase de eficiencia energética **F**  
Dieses Produkt enthält eine Lichtquelle der Energieeffizienzklasse **F**  
Dit product bevat een lichtbron met energie-efficiëntieklasse **F**

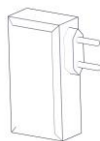
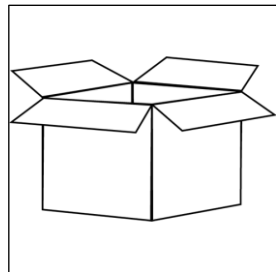
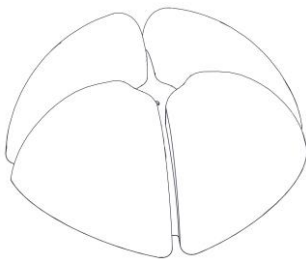
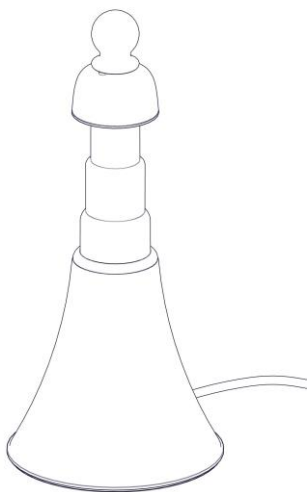

1

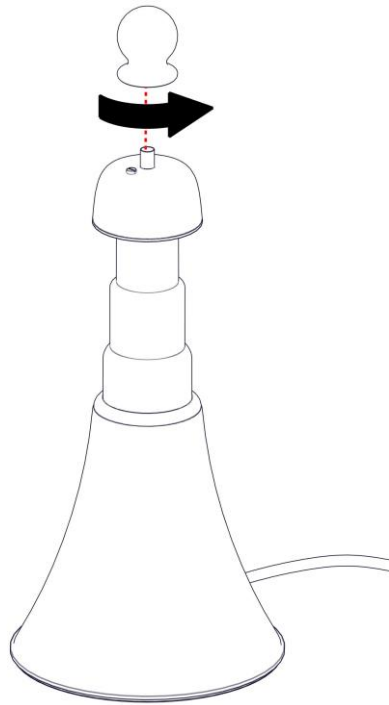

2

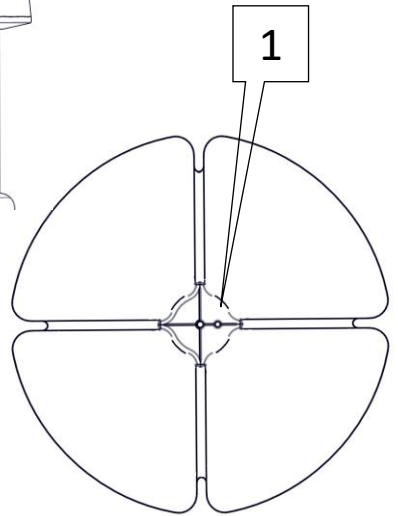
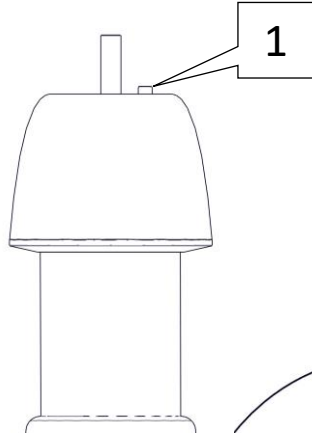
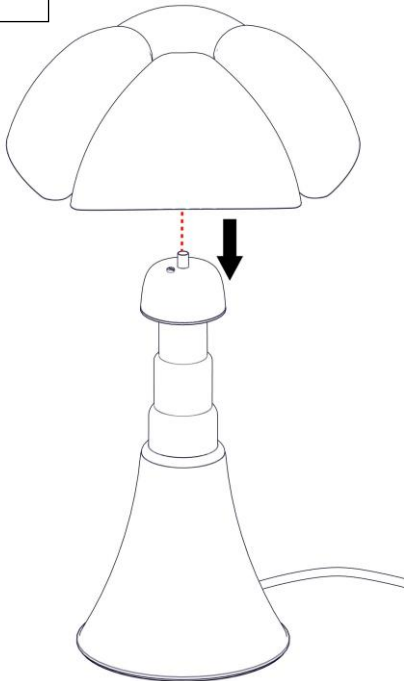

**i**

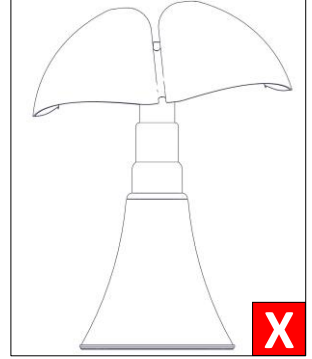
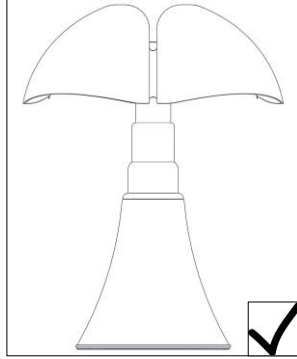
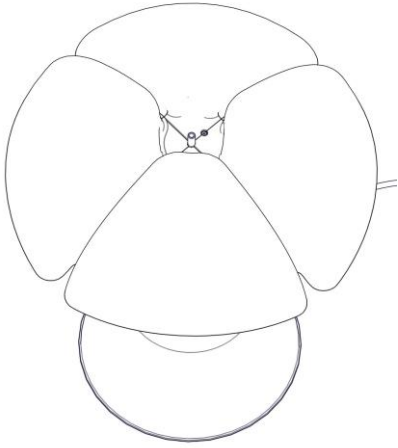

**3**

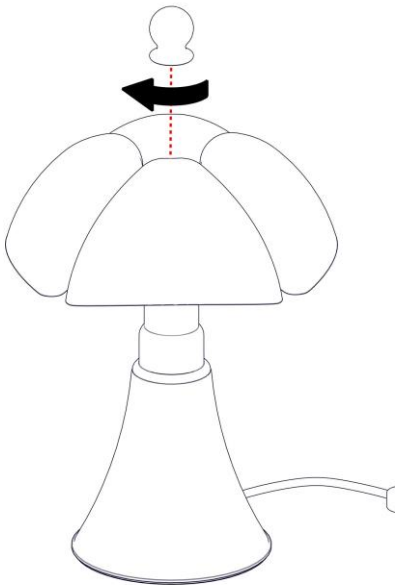

**4**

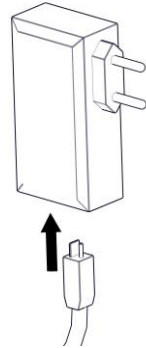

**5**

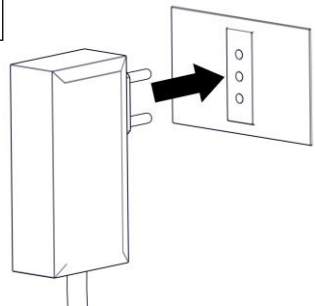

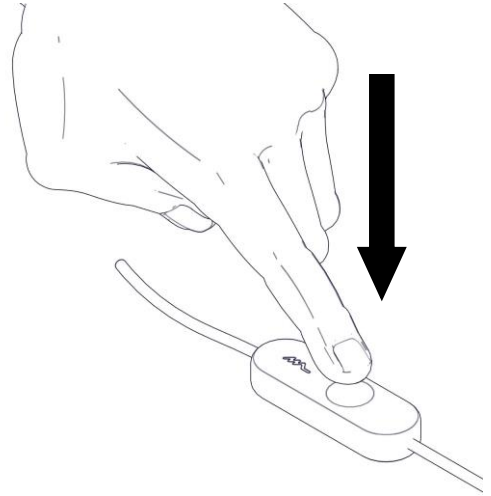
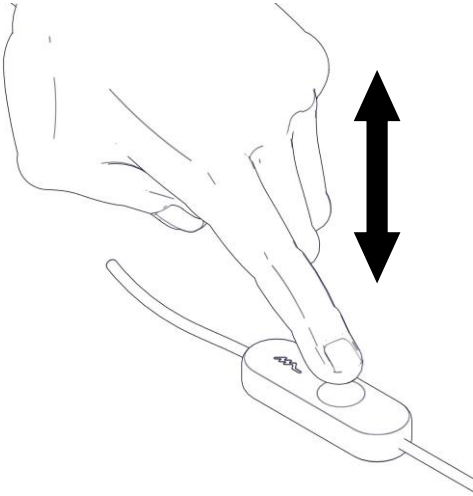

*i*

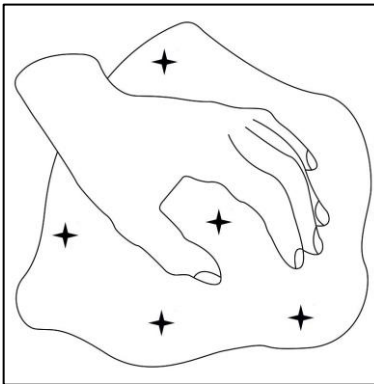



**La sorgente luminosa incorporata in questo apparecchio può essere sostituita solo dal produttore, da un suo centro assistenza oppure da una persona in possesso della necessaria abilitazione.**

**The light source contained in this luminaire shall only be replaced by the manufacturer or his service agent.**

**La source lumière de cet appareil ne sera remplacée que par l'entreprise ou par un agent reconnu.**

**Das enthaltene Leuchtmittel sollte nur durch entsprechendes fachpersonal ersetzt werden.**



# **martinelli luce**

Via Teresa Bandettini  
55100 Lucca (Lu) – Italy

Tel.+39/0583.418315  
Fax. +39/0583.419003

[www.martinelliluce.it](http://www.martinelliluce.it)  
[info@martinelliluce.it](mailto:info@martinelliluce.it)