

TANA 

15/1933.xx

15/1934.xx

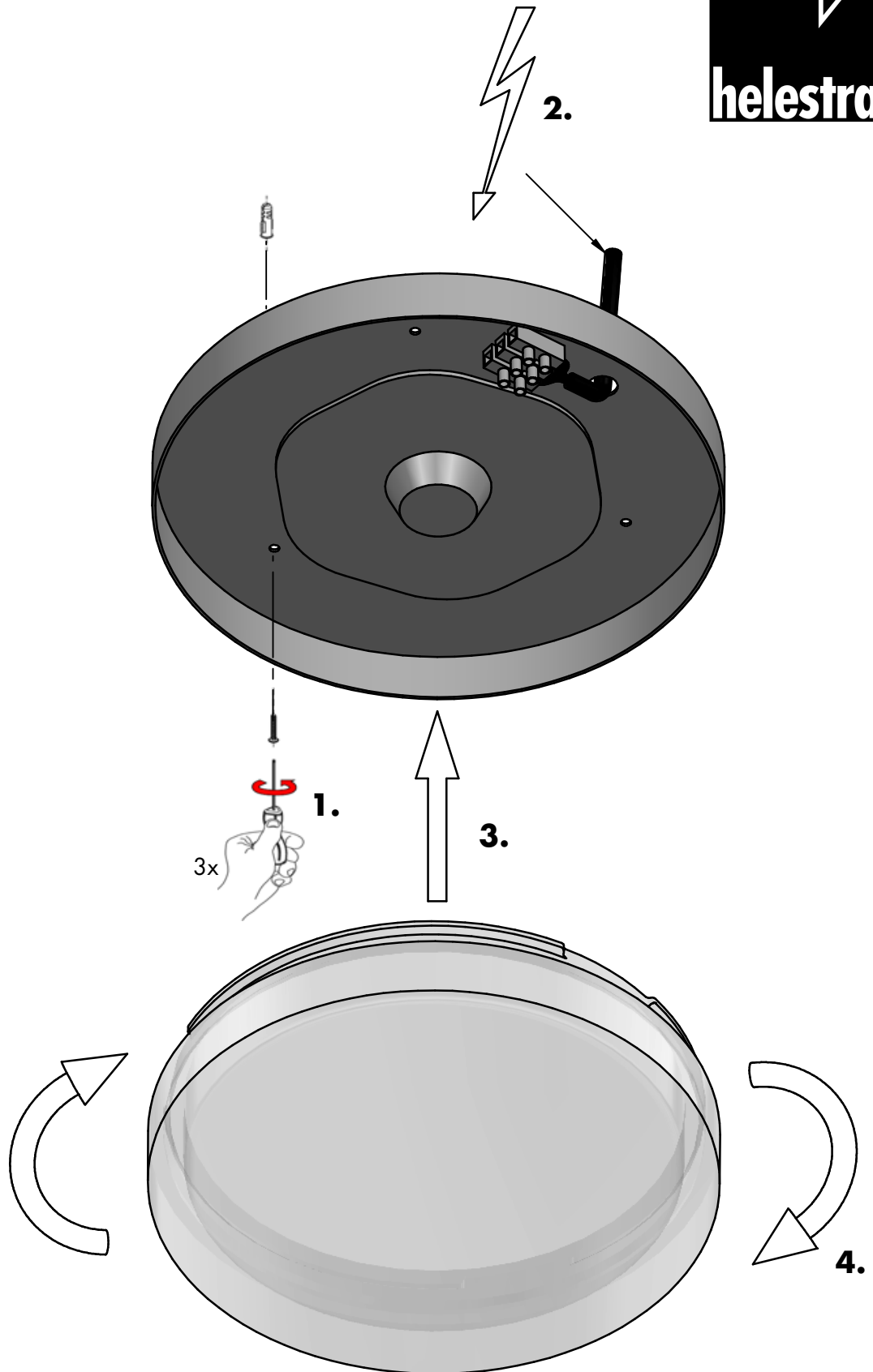
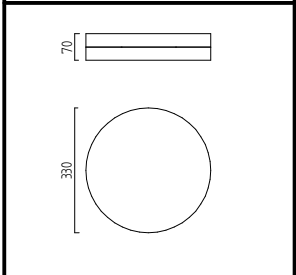
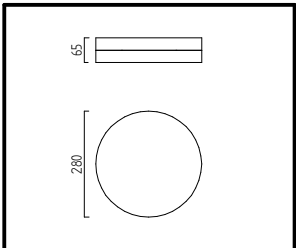
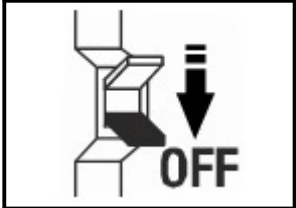
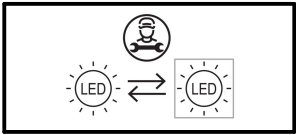
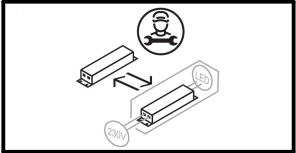

Bitte beachten Sie unsere allgemeinen Hinweise !
Please observe our general information !
Nous vous prions d'observer nos instructions g n rales !
Observen por favor nuestra informaci n general !

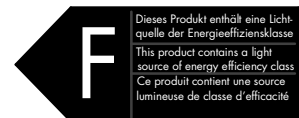

www.helestra.de/installation

Helestra Leuchten GmbH

An den Breiten 7, 01454 Leppersdorf, Deutschland/Germany

www.helestra.de