

Quick Guide

Important: Read All Instructions Prior to Installation

Function introduction

When controls RGB+CCT light devices, keep short pressing to turn on CCT channels and get 25% ww+75% cw, 50% ww+50% cw, 75% ww+25% cw, 100% ww+0% cw, 0% ww+100% cw one by one. Press and hold to adjust color temperature smoothly.

When controls RGBW light devices, keep short pressing to turn on the 4th channel W and get 25%, 50%, 75%, 100%, 0% intensity one by one. Press and hold to adjust W channel light intensity smoothly.

Press and hold down to decrease light intensity

All ON/OFF button

Click to play / pause 1 built-in RGB color changing effect, Press and hold down to speed up/down the effect

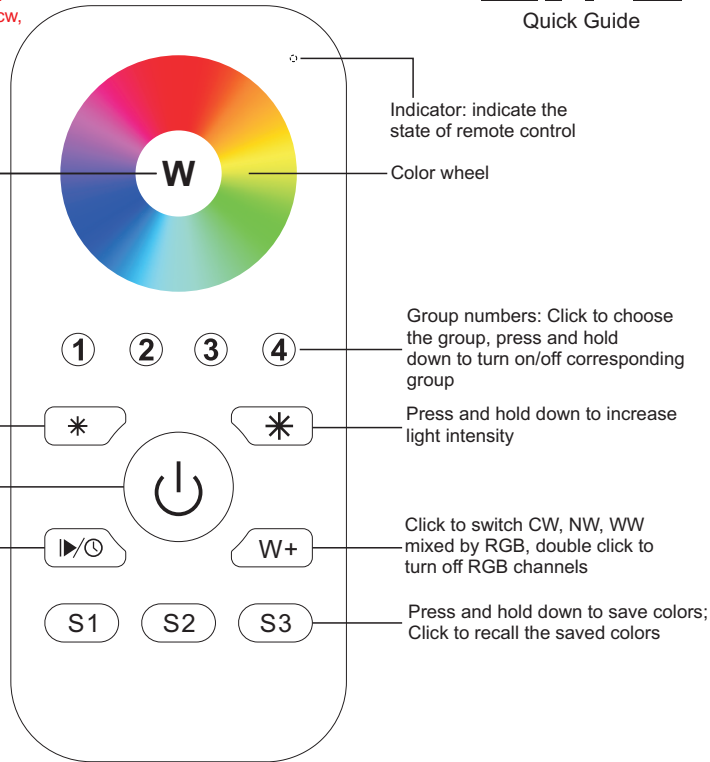

Front side

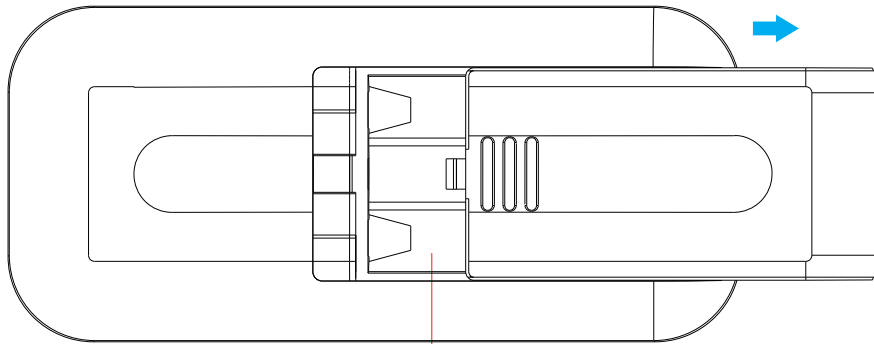

4.5V(3xAAA battery)
Bottom side

Product Data

| | |
|---------------------------------|---------------------|
| Protocol | ZigBee 3.0 |
| Operation Voltage | 4.5V(3xAAA battery) |
| Transmission Frequency | 2.4GHz |
| Transmission Range (free field) | 30m |
| Protection Type | IP20 |
| Dimming Range | 0.1%-100% |
| Dimension | 120x55x17mm |
| Protection Grade | IP20 |

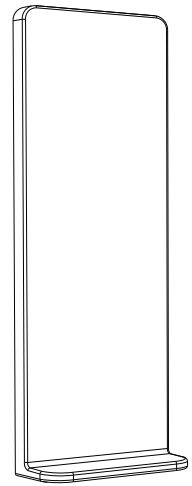

Magnetic Bracket

- ZigBee RGBW remote based on ZigBee 3.0
- Enables to control RGB, RGBW and RGB+CCT lighting devices
- High sensitive & high stable touch color wheel, fast & precise color control
- Battery powered remote with low power consumption
- Enables to pair ZigBee lighting devices through touchlink commissioning
- Supports find and bind mode to pair with ZigBee lighting devices
- Supports 4 groups for binding max. 30 lighting devices
- 2.4 GHz global operation
- Transmission range up to 30m
- Compatible with universal ZigBee Gateway products
- Compatible with universal RGBW and RGB+CCT ZigBee lighting devices

ZigBee Clusters Supported by This Remote Are As Follows:

Input clusters:

- Basic
- Power Configuration
- Identify
- Diagnostics

Output clusters:

- Identify
- Group
- Scene
- On/off
- Level control
- Ota
- Color control

Safety & Warnings

- This device contains AAA batteries that shall be stored and disposed properly.
- DO NOT expose the device to moisture.

Operation

1. This ZigBee RGBW remote is a wireless transmitter that communicates with a variety of ZigBee compatible systems. This transmitter sends wireless radio signals that are used to remotely control a compatible system.

2. This ZigBee remote supports 4 groups for binding max. 30 lighting devices and enables to control RGB ZigBee lighting devices.

3. Zigbee Network Pairing through Coordinator or Hub (Added to a Zigbee Network)

Step 1: Remove the remote from previous zigbee network if it has already been added to it, otherwise pairing will fail. Please refer to the part "Factory Reset Manually".

Step 4: Immediately short press to search nearby network, indicator flashes every 1 second, 20 seconds timeout if there is no network. Indicator will then blink 5 times quickly for successful pairing.

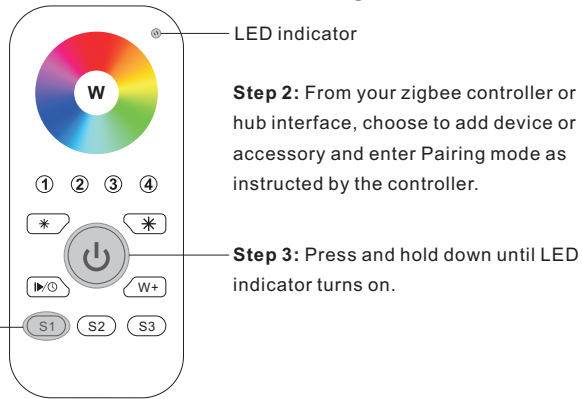

Note: 1) After pairing successfully, the remote information will appear on the controller or hub interface.

2) No remote information will appear on the hub interface if pairing to Philips Hue Bridge.

5. Removed from a Zigbee Network through Coordinator or Hub Interface

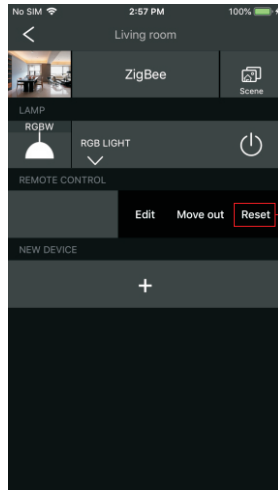

From your ZigBee controller or hub interface, choose to delete or reset the remote as instructed, indicator flashes 3 times quickly to indicate successful removing.

6. Factory Reset Manually

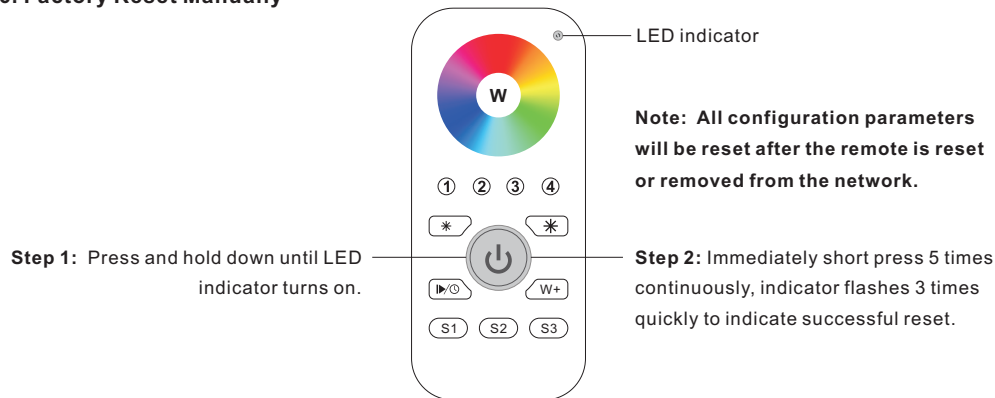

4. TouchLink to a Zigbee Lighting Device

Step 1: Set the zigbee lighting device to start TouchLink commissioning, please refer to its manual to learn how.

Step 4: Short press any button to choose a group to touchlink.

Step 5: Press and hold down until LED indicator blinks once and stay solid on.

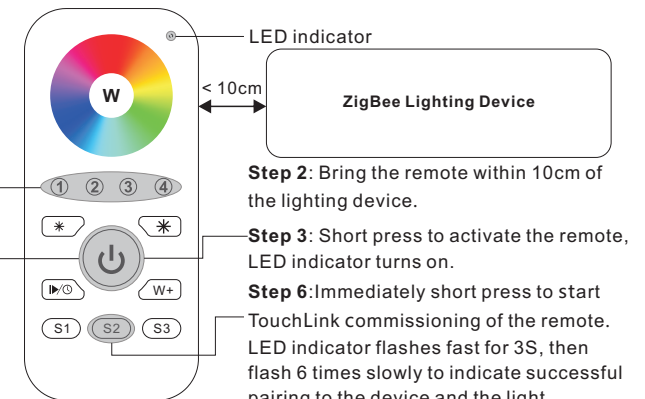

Note: 1) Directly TouchLink (both not added to a ZigBee network), each remote can link with 30 devices.

2) TouchLink after both added to a ZigBee network, each remote can link with max. 30 devices.

3) For Hue Bridge & Amazon Echo Plus, add remote and device to network first then TouchLink.

4) After TouchLink, the remote can control the linked lighting devices.

7. Remove a Touchlink Paired ZigBee Lighting Device

Step 1: Set the Touchlink paired zigbee device to start TouchLink commissioning, please refer to its manual to learn how.

Step 4: Short press the group button that the device was linked to.

Step 5: Press and hold down until LED indicator blinks once and stay solid on.

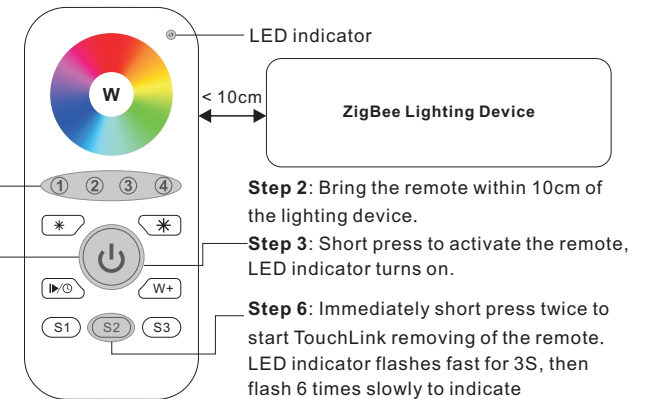

8. Factory Reset a Lighting Device (Touch Reset)

Note: the device shall be added to a network, the remote added to the same one or not added to any network.

Step 1: Set the zigbee device to start TouchLink commissioning, refer to its manual.

Step 3: Press and hold down until LED indicator turns on.

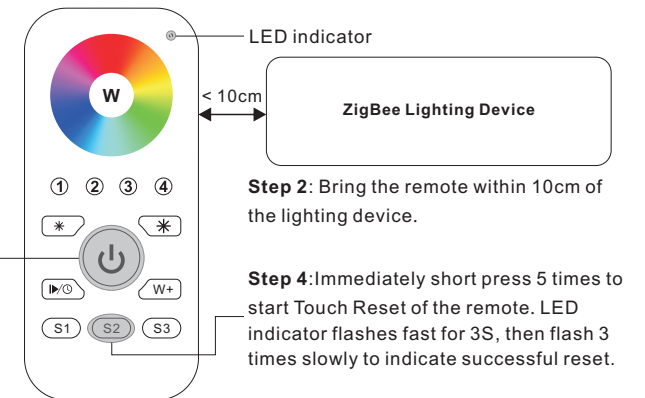

9. Find and Bind a Zigbee Lighting Device

Note: Make sure the device and remote already added to the same zigbee network.

Step 1: Start find and bind mode on the Zigbee lighting device (initiator node) and enable it to find and bind target, refer to its manual.

Step 3: Short press a group button that you would like to bind the device to.

Step 4: Press and hold down until LED indicator blinks once and stay solid on.

Note: Each remote can bind max. 30 lighting devices.

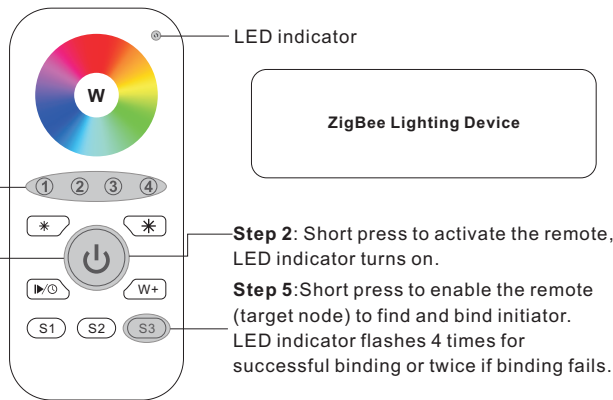

10. Find and Unbind a Zigbee Lighting Device

Step 1: Start find and bind mode on the ZigBee lighting device (initiator node) and enable it to find and unbind target, refer to its manual.

Step 3: Short press the group button that the device already bound to.

Step 4: Press and hold down until LED indicator blinks once and stay solid on.

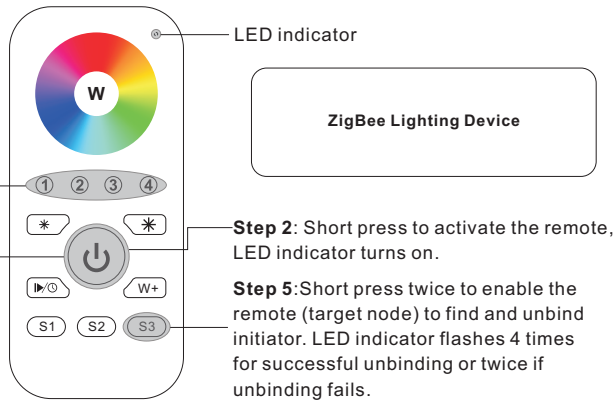

11. Clear All Find and Bind Mode Paired Lighting Devices of a Group

Step 2: Short press to choose the group that you would like to unbind all devices.

Step 3: Press and hold down until LED indicator blinks once and stay solid on.

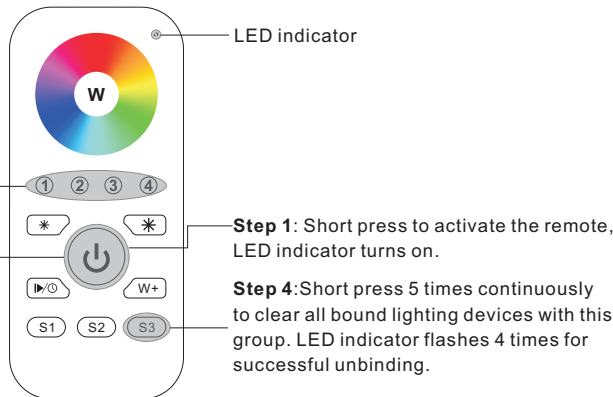

12. Setup a Network & Add Devices to the Network (No Coordinator or Hub Required)

Step 1: Factory reset the remote and the lighting device, refer to their manuals.

Step 2: TouchLink the remote and device to setup a network, refer to their manuals.

Step 3: Press and hold down until LED indicator turns on.

Step 4: Short press button S1 to enable the network to discover and add devices, LED indicator will flash twice. 180 seconds timeout, repeat the operation.

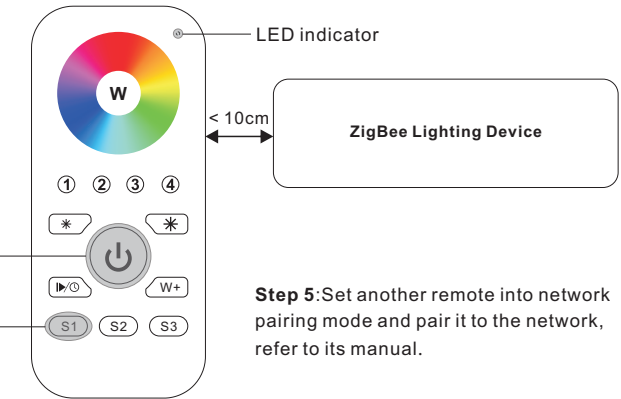

Step 6: Add more remotes to the network as you would like.

Step 7: Factory reset the lighting devices that you would like then add them to the network, refer to their manuals.

Step 8: Touchlink to pair the added remotes and lighting devices, refer to their manuals. Each remote can link with max. 30 lighting devices. Each lighting device can be linked by max. 30 remotes.

13. OTA

The remote supports firmware updating through OTA, and will acquire new firmware from zigbee controller or hub every 10 minutes automatically.

14. How to Check Whether the Remote Belongs to a Network or not

Activate the remote by clicking All On/Off button (indicator on), then short press any other buttons except group buttons, indicator blinking 3 times means the remote does not belong to any network, blinking once or twice means it has already been added to a network.

15. Battery Power Monitor Function

The remote will report battery power value to the coordinator under following situations:

- When powered on.
- When short pressing both S2 and S3 buttons simultaneously.
- When operating the switch to send data packets (over 4 hours since last operation).
- When added to the network by a coordinator.