

# ALVA

lampshade | user guide



UMAGE



## WITH LOVE FROM COPENHAGEN

At UIMAGE, our designers take inspiration from the distinct nature of the Nordic landscape to create unique designs related to the way we live in an urban setting. Influenced by the design language, colours and materials found around us in Scandinavia, we create a collection that is rooted in our home but designed for everyone.

Versatile, flexible and multifunctional, our designs are created to enhance an urban lifestyle in smaller spaces!



DESIGNED BY  
LORENZO RADAELLI

“ Some lampshades are  
just so beautiful that  
you feel compelled to  
make them. ”

# ASSEMBLY GUIDE

Ⓑ x 1 pc.

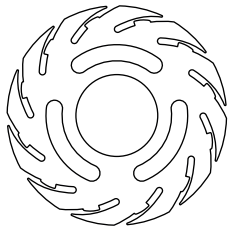

Ⓐ x 12 pcs. (+1)

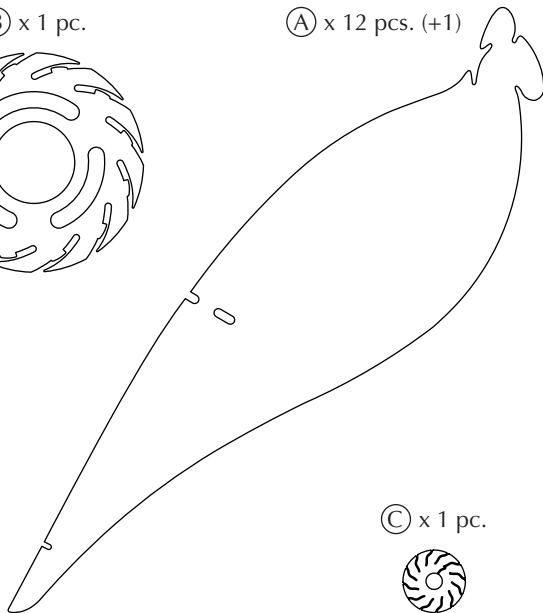

Ⓒ x 1 pc.



Find assembly videos by using the QR code or by going online at our website  
[umage.com/instructions](https://umage.com/instructions)

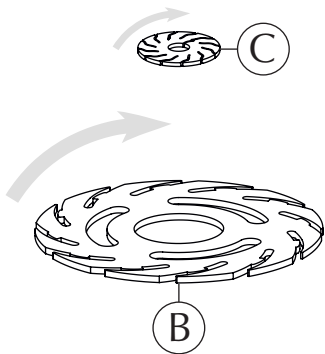

=

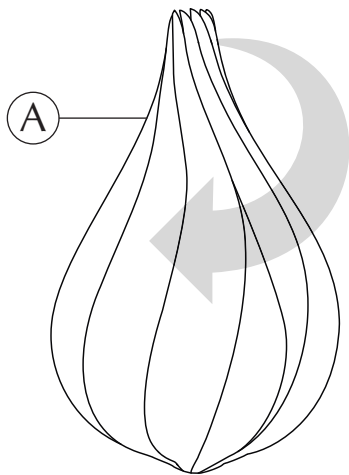

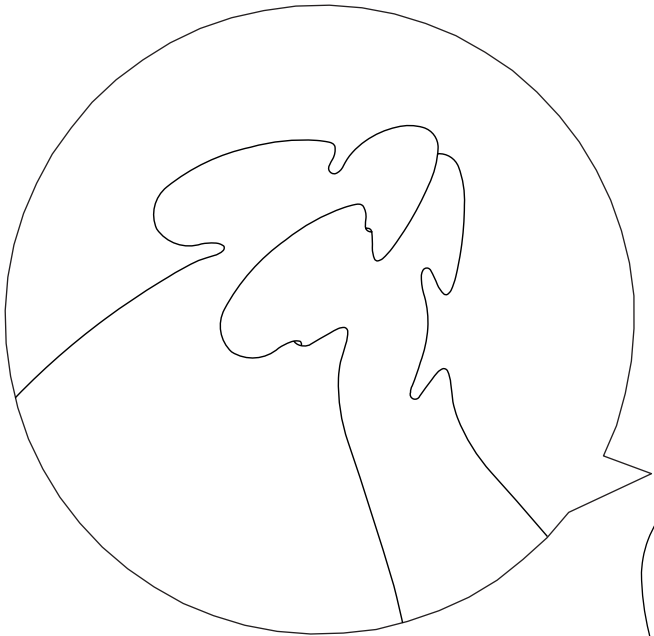

A

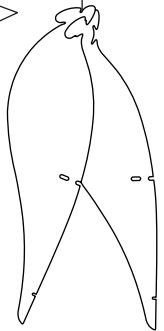

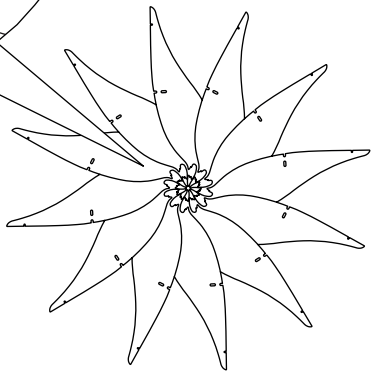
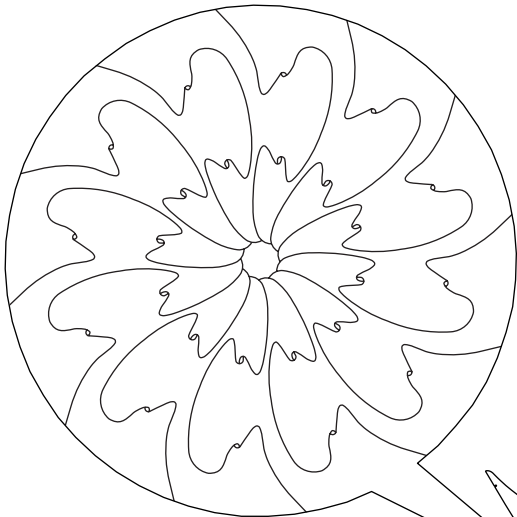



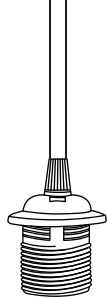

E27/E26



B



MAX 15W LED BULB

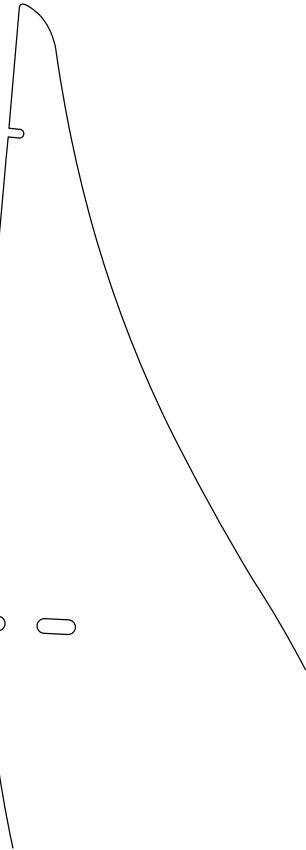
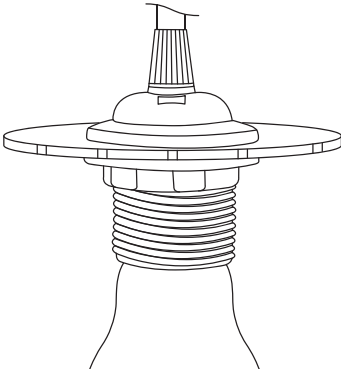
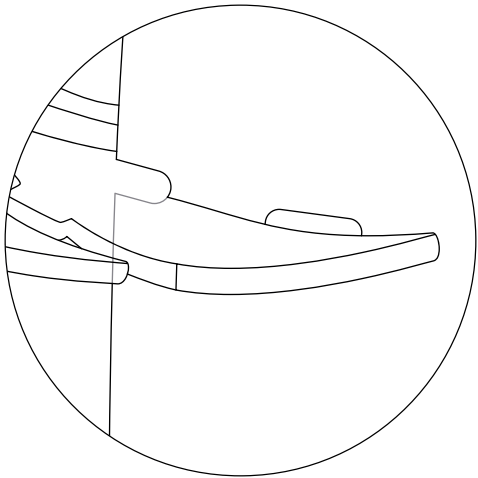

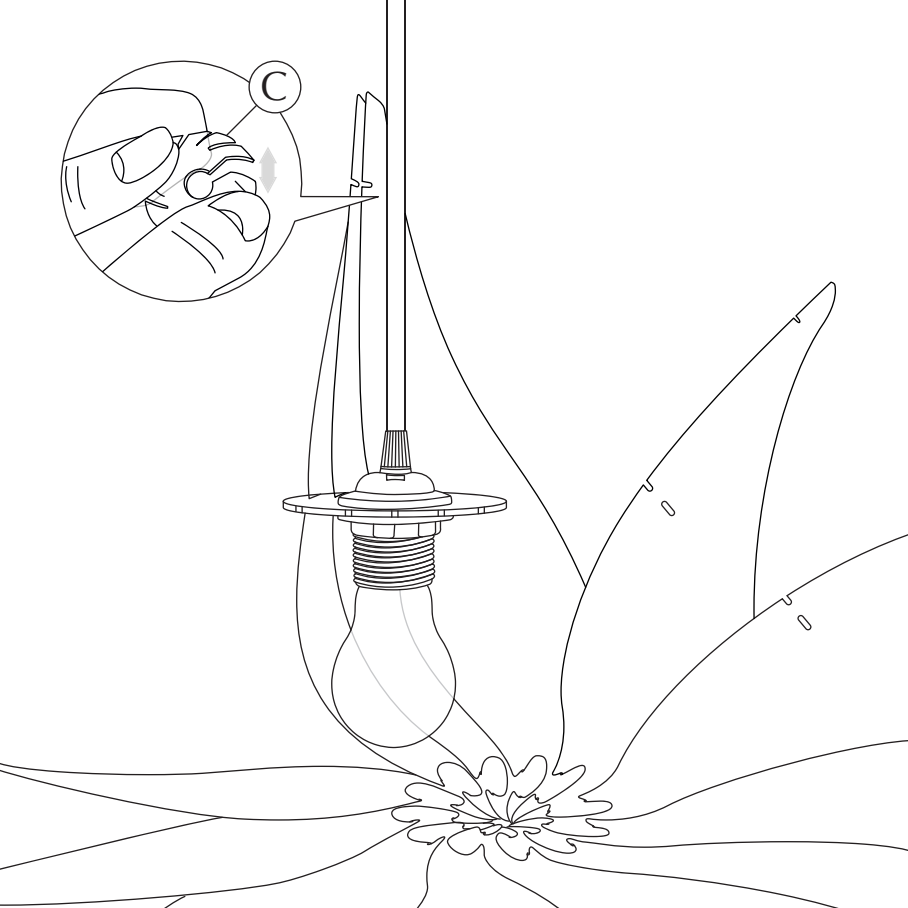

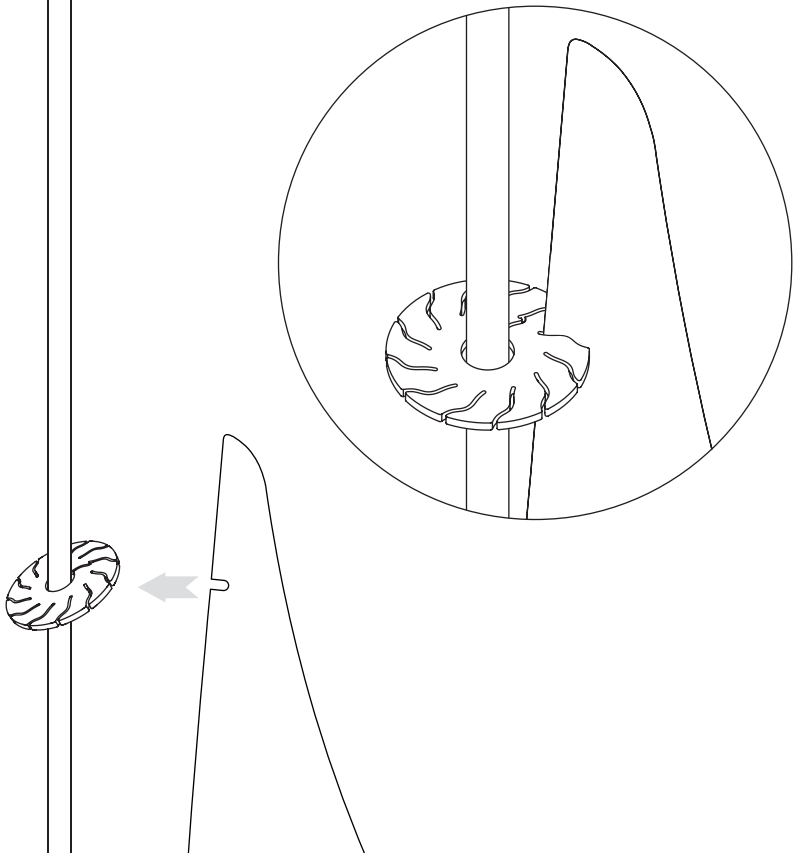

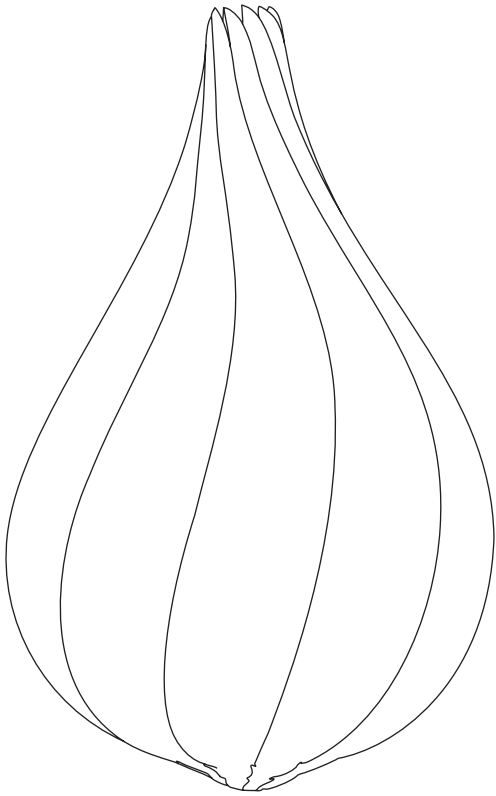

## **ENGLISH**

Wash with soap before use to avoid attraction of dust.

## **DEUTSCH**

Waschen Sie die Lampe vor Gebrauch mit Seife ab um Staubanziehung zu vermeiden.

## **FRANÇAIS**

Laver au savon avant employ pour éviter que la poussière ne se dépose.

## **NEDERLANDS**

Voor gebruik met zeep wassen om het aantrekken van stof te voorkomen.

## **DANSK**

Vask med sæbe før brug for at undgå støvtiltrækning.

## **NORSK**

Vask med såpe før bruk for a hindre tiltrekning av støv.

## **SUOMI**

Pese saippualla ennen käyttöä vähentääksesi pölyn kerääntymistä.

## **SVENSKA**

Tvätta med såpa före användning för att undvika att den drar till sig damm.

## **ESPAÑOL**

Lavar con jabón antes de utilizar para que no atrape polvo.

## **ITALIANO**

Onde evitare il deposito di polvere, lavare con acqua e sapone.

## **POLSKI**

Przed użyciem umyć mydłem, aby uniknąć przyciągania kurzu.

## **PORTUGUÊS**

Lavar com sabão antes de utilizar para evitar a atracção de pó.

## **РУССКИЙ**

Для предотвращения попадания пыли перед использованием вымыть с мылом.

## **中文**

为避免吸尘,使用前请在肥皂水里 浸泡清洗.

## **한국어**

먼지가 묻지 않도록 사용 전에 비누로 닦아 주십시오

## **日本語**

埃を吸引することを避けるため、使用開始前に石鹼で洗ってください

## SUSTAINABLE SUSTAINABILITY EFFORTS

We are dedicated being sensible frontrunners on the environmental responsibility. If we provide timeless and functional quality designs that last, we know nature will prevail, as will UIMAGE.

*“SAVING THE SCENT OF THE FOREST  
AFTER AN EARLY MORNING RAIN”*



### GIVING BACK TO NATURE

In collaboration with the NGO One Tree Planted, we are planting a tree every time one of our designs made from wood are being sold. Furthermore, we are compensating for the polypropylene products we sell, by donating part of the profits to the NGO Plastic Change, supporting the World ocean clean-up and minimizing plastic pollution.



## MULTIFUNCTION AND FLEXIBILITY

One of the key aspects of the designs at UIMAGE is multiple functions and flexibility. Designing with more than one function in mind is a sustainable mindset as it reduces the number of products you need to buy to get a complete setting for your space.



## REUSABLE PACKAGING

To minimize packaging waste, most of the packaging from our lighting collection is repurposed to be used as beautiful storage boxes afterwards. Learn more on the next page...



## REUSABLE PACKAGING

With your new lamp, you have also received a free decorative storage box for the shelf.

### THIS IS HOW IT WORKS

When your new lamp is out of the box you can keep the box and reuse it as a storage box for your small bits and bobs and place it on the shelf or on the top of your closet - repurposing the packaging for you and the environment.

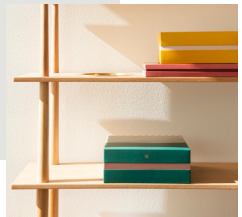

So not only are UIMAGE's designs flat-packed to optimize the global logistics and the environmental footprint, but it ensures that you don't need to throw away tons of packaging material, that can just as well be reused for something new.

Read more about our many sustainability efforts:  
[umage.com/sustainability](https://umage.com/sustainability)



Please follow the marked icons on the packaging materials for correct disposal of the remaining packaging materials:



CARDBOARD



PAPER



Recycle your waste correctly  
by searching for these icons on  
the packaging

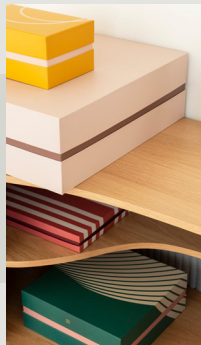

FOLLOW US ON SOCIAL MEDIA



@umagedesign | #umagedesign | [umage.com](http://umage.com)



UIMAGE



210330